

Automation System TROVIS 5400 Heating and District Heating Controller TROVIS 5432



Fig. 1 · Type 5432

Mounting and operating instructions

EB 5432-1 EN

Firmware Version 1.00
Edition September 2001



Contents	Page
1. Notes for the user	5
2. Operation	6
2.1 Control levels	6
3. Start-up	8
4. Setting options on the display level	9
4.1 Short-term change in room temperature	9
4.2 Party mode	9
4.3 Holiday mode	10
5. Setting options on the user level	11
5.1 Setting the current time and date	12
5.2 Setting the times-of-use	13
5.2.1 Reading the set times-of-use	16
5.3 Setting the reference value for room temperature or the flow temperature set point for rated and reduced operation	17
5.4 Viewing the outdoor temperature	18
6. Configuration and parameterization	19
6.1 Accessing the installation level	19
6.2 Setting the function blocks and parameters	20
7. Description of the controller functions	22
7.1 Operating modes	22
7.1.1 Weather-compensated control	23
7.1.1.1 Heating characteristic	23
7.1.1.2 Fixed set point control	24
7.2 Delayed outdoor temperature adaptation	25
7.3 Control signal	25
7.3.1 Three-step control	25
7.3.2 On/off control	26
7.4 Limitation of the flow temperature	26
7.5 Limitation of the return flow temperature	27
7.6 Drinking water priority	27
7.7 Subfloor drying	28
7.8 Heating deactivation during the time-of-use	28
7.9 Heating deactivation during the time of non-use	28
7.10 Manual operation	29

7.11	Pump seizure protection	29
7.12	Defective sensors	30
7.13	Actual values	30
8.	Installation and electrical connections	31
8.1	Installing the controller	31
8.2	Electrical connections	32
8.2.1	Installation recommendations	32
8.3	Connecting the controller	33
8.4	Connecting the sensors	34
8.4.1	Pt 1000 sensor values	34
8.5	Connecting the actuator	34
8.6	Connecting the pump	34
9.	Technical data	35
	Quick guide	36



- ▶ *Assembly, start-up and operation of the device may only be performed by trained and experienced personnel familiar with this product. According to these mounting and operating instructions, trained personnel is referred to persons who are able to judge the work they are assigned to and recognize possible dangers due to their specialized training, their knowledge and experience as well as their knowledge of the relevant standards.*
- ▶ *The controller is designed for use in power installations. For connection and maintenance you are required to observe the relevant safety regulations.*
- ▶ *Proper shipping and appropriate storage are assumed.*

1. Notes for the user

The controller is ready for operation with its factory (default) settings for temperatures and time schedules.

On start-up, after switching on the power supply, you must enter the **current time and date**. Refer to chapter 3 for further information about how to proceed.

Times-of-use and room set points that can be easily changed by the end user are described in chapter 5. In addition to this, the end user can make short-term changes to the reference value or set point (chapter 4).

However, configuring the controller as well as setting the control parameters as described in chapter 6 require specialized knowledge of heating systems and should only be performed by an expert. This also applies for the description of the controller functions listed in chapter 7.

PC-supported configuration

The TROVIS-VIEW Configuration and Operator Interface software allows you to create all the configuration data on a PC/laptop and download them onto the controller via its infrared interface using an infrared adapter.

Refer to the operating instructions EB 5432-2 EN about how to configure the controller using TROVIS-VIEW software.

Validity of these mounting and operating instructions:

Firmware version 1.00 and higher

(Current Firmware version appears in the display for 2 s when the power supply is switched on)

2. Operation

Just one control knob is needed to operate the controller.

- ▶ Turning the knob lets you change the current reference value or set point or lets you select parameters and temperatures.
- ▶ Pressing the knob for three seconds lets you switch over from one control level to the next.
- ▶ Pressing the knob briefly lets you activate a parameter to change it or lets you acknowledge a changed parameter.

2.1 Control levels

There are three levels to operate the controller.

Certain parameters with their assigned symbols appear in the display depending on the level chosen.

The levels important for the end user are the display level and the user level.

The installation level designed for the expert is described in more detail in chapter 6.

Display level

Depending on the operating mode set in the installation level:

- ▶ Lets you view the reference value for room temperature when the weather-compensated control is active.
- ▶ Lets you view the set point and the actual value of the flow temperature when the fixed set point control is active.
- ▶ Lets you change the currently valid reference value or set point. This change then applies until the time-of-use or time of non-use ends.

User level

- ▶ Lets you view the time, time-of-use periods and the reference values or set points.
- ▶ Lets you view the outdoor temperature when a sensor is connected.
- ▶ Lets you set the time (and date).
- ▶ Lets you set the time-of-use periods for rated operation.
- ▶ Lets you set the required reference values for room temperature for rated and reduced operation during weather-compensated control or lets you set the set points for the flow temperature during fixed set point control for rated and reduced operation.

Installation level

- ▶ Lets you configure and parameterize the controller.
- ▶ Lets you view the actual values measured by the connected sensors.

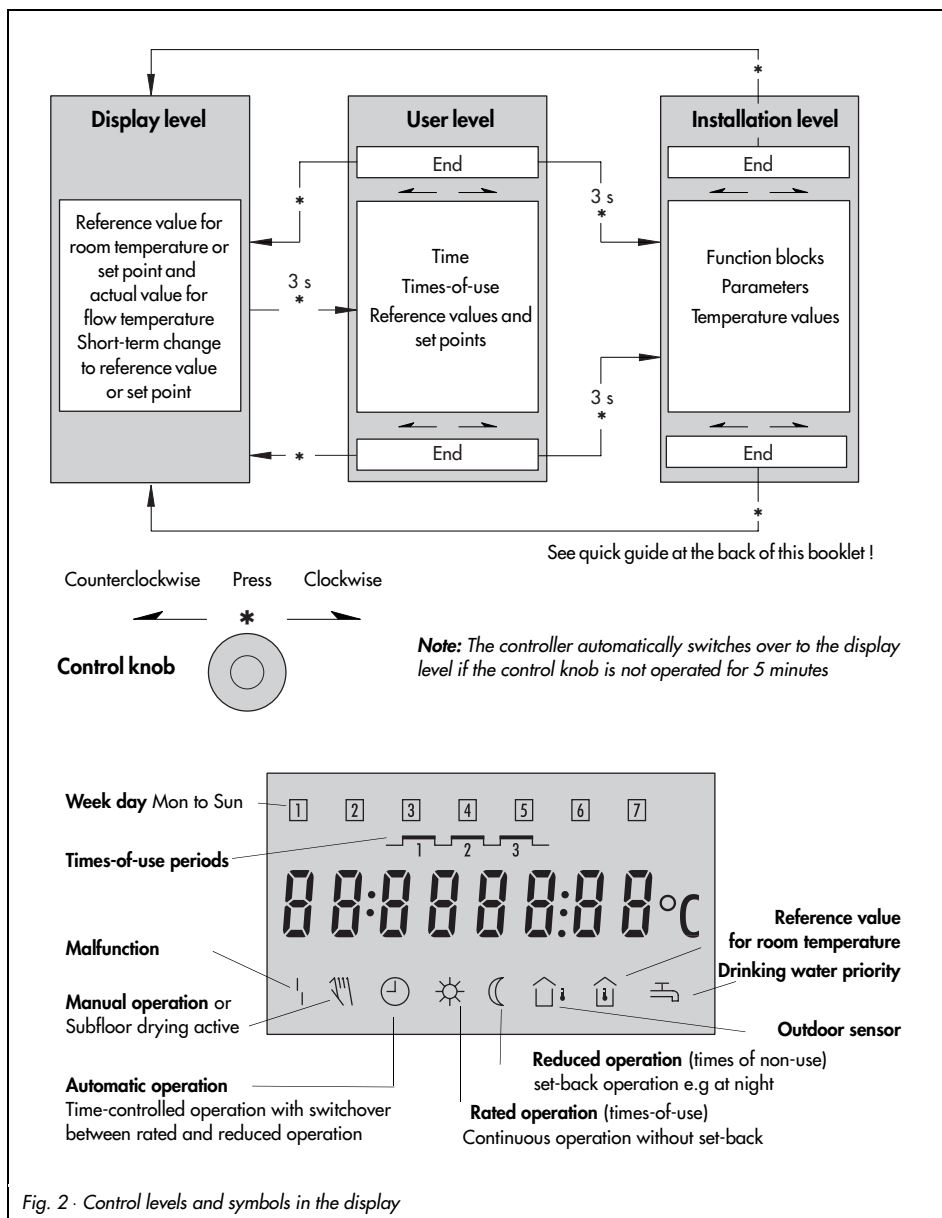

Fig. 2 · Control levels and symbols in the display

3. Start-up

The controller is ready for use with its factory (default) settings after it has been installed and the power supply has been connected.

To start up, switch on the power supply.

Setting the current time and date

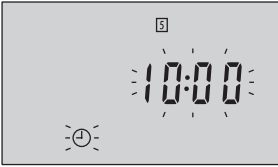

When the controller is started up for the first time or the controller is disconnected from the power supply for more than 72 hours, the default setting with blinking time appears in the display.

Now set the time and date.



Turn the control knob until you reach the correct time and press the knob to acknowledge the time.



The year 2001 appears in the display as the default setting. Turn the control knob if you want to change the year and press the knob to acknowledge the year.



The date (day and month) appear in the display as the default setting.

Turn the control knob to set the date and press the knob to acknowledge the date.



You have now completed entering the time and date. The controller switches automatically to the display level. The reference value for room temperature or set point and actual value for the flow temperature appear in the display.

For further information about setting other parameters, please refer to the following chapters.

4. Setting options on the display level

The display level provides the following setting options that are only effective for a certain time:

- ▶ If the current room temperature is too warm or too cold, you can override the controller setting.
- ▶ If you would like to prevent the controller from switching over to the reduced mode (for example, due to a party or public holiday) and continue heating, you can set the controller to **Party** mode.
- ▶ If you would like to switch off the heating for longer periods of time (for example, vacation), you can set the controller to **Holiday** mode.

4.1 Short-term change in room temperature

If you change the preset reference value for room temperature or set point for flow temperature, this change remains effective until the next time-of-use or time of non-use comes into effect.

When the weather-compensated control is activated, the reference value for room temperature appears in the display or when the fixed set point control is activated, the set point for flow temperature appears on the left-hand side of the display.

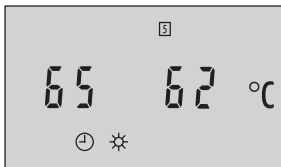

Turn the control knob clockwise or counterclockwise one position, after a brief interval, the clock and sun symbols start to blink.

You can now set the reference value for room temperature or the set point for flow temperature to the required value. Press the knob to acknowledge the setting.

Alternatively, you can wait three seconds until the display stops blinking. The new value is stored.

4.2 Party mode



If you would like to continue heating in rated operation, yet this deviates from the time schedule, you can achieve this as follows:

Turn the control knob clockwise until **PARTY** appears in the display.

Press the knob to acknowledge the setting.

Alternatively, you can wait three seconds until the display stops blinking. The party mode is activated.

The party mode remains effective until a different reference value or set point is entered. Even after a power failure, the party mode remains effective.

If you want to end the party mode, turn the control knob counterclockwise one position. Wait briefly and then turn the knob one position further, then the set reference value or set point reappears in the display.

4.3 Holiday mode

If you switch off the heating, but would like the frost protection to remain active, proceed as follows:

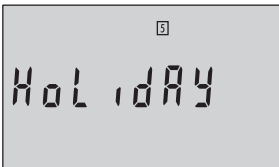

Turn the control knob counterclockwise until **HOLIDAY** appears in the display.

Press the knob to acknowledge the setting.

Alternatively, you can wait three seconds until the display stops blinking. The holiday mode is activated.

The frost protection function comes into effect when the outdoor temperature falls below 3 °C when the weather-compensated control is activated or the flow temperature falls below 5 °C when the fixed set point control is activated. The circulation pump is activated and the flow temperature is controlled to 20 °C. During fixed set point control, the circulation pump runs continuously.

Note: *The frost protection function is not active when the controller is set to manual operation.*

The holiday mode setting remains effective until a different reference value or set point is entered. Even after a power failure, the holiday mode remains effective.

If you want to end the holiday mode, turn the control knob clockwise one position. Wait briefly and then turn the knob one position further, then the set reference value or set point reappears in the display.

5. Setting options on the user level

The controller is set to the display level.



The controller is set to the operating mode "Weather-compensated control" as default. The room reference value appears in the display.

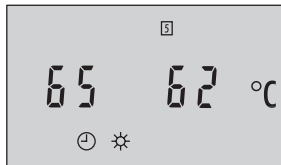

If the operating mode has been changed to "Fixed set point control", the set point appears on the left-hand side and the actual value of the flow temperature on the right-hand side of the display.

Switching over to the user level

If you want to enter different times-of-use, reference value and set points that deviate from the default settings, you must first **press the control knob for three seconds** to access the user level.

At first, the time appears in the display on the user level. Turn the control knob to continue to the setting options described in following.

5.1 Setting the current time and date

A time appears in the display or, if the controller has not been in operation for the past 72 hours, the default setting **10:00** appears in the display.

You only need to change the time and date, if they are different from the time and date entered during start-up.

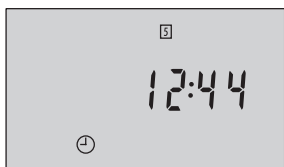

Press the control knob. The clock symbol starts to blink.
Turn the control knob to until you reach the correct time and press the knob to acknowledge the time.

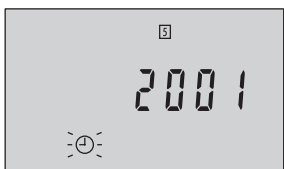

The year **2001** appears in the display as the default setting.
Turn the control knob if you want to change the year and press the knob to acknowledge the year.



The date (day and month) appear in the display as the default setting.
Turn the control knob to set the date and press the knob to acknowledge the date.

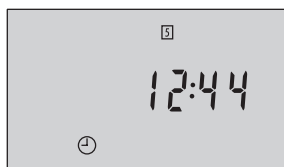

You have now completed entering the time and date. The time, date and the clock symbol reappear in the display.

If you want to remain on the user level, you can now enter the times-of-use (chapter 5.2) by turning the control knob one position further.

If you do not want to continue, turn the control knob until **End** appears in the display. Then press the knob to access the display level.

Alternatively, if you wait five minutes, the controller automatically returns to the display level.

5.2 Setting the times-of-use

You can enter three time periods for the time-controlled operation for every day of the week, during which the heating system runs in rated operation.

The default setting is a daily rated operation with just one period of time-of-use from **7:00 to 22:00 hrs.**

During this time period, the heating system runs dependent on the predetermined operating mode: weather-compensated according to the set heating characteristic or over a fixed flow set point.

The heating system is switched over to reduced operation when the time-of-use period ends. This saves energy in the times of non-use, e.g. at night time.

The heating system runs with a lower reference value during reduced operation.

You can set the reference value for room temperature directly after setting the times-of-use (chapter 5.3).

The heating system switches back to rated operation again when the reduced operation ends. You can enter the three time-of-use periods (1, 2 and 3) weekly (1 to 7) with the same time schedule daily or on a day-to-day basis (1, 2, 3 etc.).

Note:

If you want to enter time-of-use periods that are different on just one day or on a few days of the week, first select the week entry with the same time schedule daily. Then turn the control knob until the day, which should have different times-of-use, appears in a box at the top of the display. Enter the new schedule. When you enter a new schedule, you write over the weekly entered times-of-use on the selected day.

Caution:

If you select the week entry to enter schedule, you write over all time-of-use periods that have already been entered.

Note: An optimize function is included in the controller. This function makes sure that the controller automatically switches the heating circuit to the reference value or set point that applies to the time-of-use at least 59 minutes before it starts dependent on the outdoor temperature. The sun symbol blinks in the display when this function becomes effective.



If you are not on the user level, press the control knob for three seconds.

First of all, the time appears in the display.



Entering a weekly schedule

Turn the control knob clockwise one position. The current time-of-use appears in the display.

Press the control knob. The time period symbol starts to blink.

Turn the control knob until the numbers for all days 1 to 7 in boxes appear at the top of the display and the first time period $\bar{1}$ appears.

Press the control knob. The time when the first time period starts appears in the display, the clock and sun symbols start to blink.

Turn the control knob to set the time when you want the first time period to start (30 min increments) and press the knob to acknowledge the setting.

The time when the first time period stops appears in the display.

Turn the control knob to set the time when you want the first time period to end and press the knob to acknowledge the time.

The start and stop of the time period you have just entered appears in the display. This time period applies to all days of the week.

Turn the control knob clockwise one position to access the second time period $\bar{2}$.

Press the control knob to the time when you want the second time period to start and end as already described above.

Note: The second time period has to be outside of time period $\bar{1}$. If you set the start and stop of a time period to have the same time, the time period is not activated.

You only need to set other times if you require time periods $\bar{2}$ and $\bar{3}$.

Proceed in the same manner for the third time period $\bar{3}$. The third time period has to be outside of time periods $\bar{1}$ and $\bar{2}$.

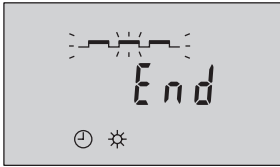

After you have entered the last time-of-use period, the time period symbol still blinks. Turn the control knob clockwise one position further. **End** appears in the display.



Press the control knob to acknowledge the settings. The stop and start times for the time-of-use period T of the current day (today) appear in the display.

If you do not want to continue:

Turn the control knob until **End** appears in the display. Press the control knob. The controller switches to the display level.

If you want to change the time schedule for individual days:

Turn the control knob until the box for the required day appears at the top of the display.

Press the control knob and set the time-of-use periods for this day in the same manner as already described for the week entry.



Entering schedule on day-to-day basis

If you are no longer on the user level, press the control knob for three seconds.

At first, the time appears in the display.

Turn the control knob clockwise one position. The currently valid time-of-use appears in the display.

Press the control knob. The time period symbol starts to blink.

Turn the control knob until the box for the required day appears at the top of the display.

The start and stop times for the first time-of-use period appear in the display.

Press the control knob and set the time-of-use periods for this day in the same manner as already described for the week entry.



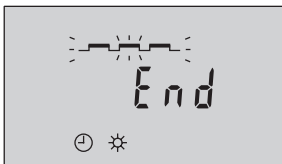

After entering the last time-of-use period, the time period symbol still blinks in the display, turn the control knob to access the next day and set likewise the required time-of-use periods.

Repeat the setting procedure for all of the following days.

After entering the last time-of-use period, the time period symbol still blinks in the display, turn the control knob clockwise or counterclockwise until **End** appears in the display.

Press the control knob to acknowledge the settings.

The start and stop times for the currently valid time-of-use period appear in the display.

Turn the control knob until **End** appears in the display.

Press the control knob,

the controller switches over to the display level.

5.2.1 Reading the set times-of-use

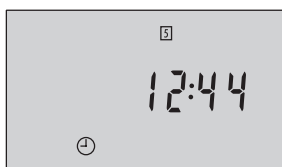

If you want to check the set times-of-use, you can view each individual day.

If you are not on the user level, press the control knob for three seconds.

First of all, the time appears in the display.

Turn the control knob clockwise one position. The currently activated time-of-use appears in the display.

Press the control knob. The time period symbol starts to blink.

Now you can read all the time-of-use periods for each day of the week by turning the control knob.

If you want to exit this menu:

Turn the control knob until **End** appears in the display.

Press the control knob, the currently active time-of-use appears in the display.

Turn the control knob until **End** reappears in the display.

Press the control knob,

the controller switches over to the display level.

5.3 Setting the reference value for room temperature or the flow temperature set point for rated and reduced operation



If you are not on the user level, press the control knob for three seconds.

At first, the time appears in the display.

Turn the control knob clockwise two positions.



In the operating mode "**Weather-compensated control**", the **reference value for room temperature** for rated operation (time-of-use) appears in the display.

The default value is 20.0.

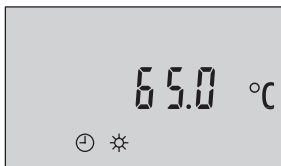

In the operating mode "**Fixed set point control**", the **flow temperature set point** for rated operation (time-of-use) appears in the display.

The default value is 65.0 °C.

If you want to change the currently displayed value:

Press the control knob. The symbols at the bottom of the display start to blink.

Turn the control knob to set the required value and press the knob to acknowledge the set value.

Turn the control knob one position further to access the reference value for room temperature or flow temperature set point for reduced operation (time of non-use).



In the operating mode "**Weather-compensated control**", the **reference value for room temperature** for reduced operation (time of non-use) appears in the display.

The default value is 17.0.



In the operating mode "**Fixed set point control**", the **flow temperature set point** for reduced operation (time of non-use) appears in the display. The default value is 50.0 °C.

If you want to change the currently displayed value: Press the control knob. The symbols at the bottom of the display start to blink.

Turn the control knob to set the required value and press the knob to acknowledge the set value.

If you turn the control knob one position further, you can view the current outdoor temperature (see the next chapter).

5.4 Viewing the outdoor temperature

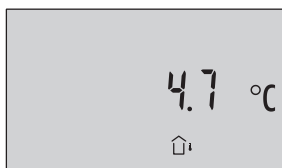

When an outdoor temperature sensor has been connected, the outdoor temperature is displayed on the user level after the reference value for room temperature or flow temperature set points.

6. Configuration and parameterization

The controller configuration and parameterization are entered on the installation level.

After accessing the installation level, the function blocks F1 to F6 appear first of all, followed by the parameters P1 to P15 and finally the measured temperatures t1 to t4.

You can select function blocks, parameters and measured temperatures you require by turning the control knob.

Set the function blocks to **1** = ON or **0** = OFF depending on the function required. Set the parameters to any value within a predetermined value range.

The function blocks and parameters are listed together with their meaning and default setting in the table on page 20 and 21.

6.1 Accessing the installation level



Press the control knob for three seconds to change over from the display level to the user level.

At first, the time appears in the display.

Turn the control knob clockwise or counterclockwise until **End** appears in the display.

Press the knob again for 3 seconds,

the installation level is opened when the first function block **F1** appears in the display.

Now you can continue to all other function blocks, to the parameters and the temperatures by turning the control knob.

To make any changes, press the control knob when you reach the function block or parameter you want to change. Turn the knob to set and press it to acknowledge the new setting.

6.2 Setting the function blocks and parameters

Note: When you set certain function blocks, the associated parameter needs to be set, too.

The function blocks (F) and parameters (P) are listed in sequence. Further details about the functions are described in chapter 7.

F	P	Function	S	FS	Comment / range
		F = Function block P = Parameter S = Setting FS = Factory (default) settings			
F 1		Operating mode	1 0	1	Weather-compensated control Fixed set point control (Chap. 7.1)
	P1	Gradient Heat. characteristic		1.6	0.2...3.2
	P2	Level Heating characteristic		0.0	-30.0...30.0 °C
F 2		Manual operation	1 0	0	Active Not active (Chap. 7.10)
F 3		Delayed outdoor temperature adaptation	1 0	0	Active with outdoor sensor AS (Chap. 7.2)
	P7			5	1...6 °C/hr
F 4		Control signal 3-step	1	1	Three-step control (Chap. 7.3.1)
	P10	Kp Gain		2.0	0.1...50.0
	P11	Tn Reset time		120	0...999 s
	P12	Ty Valve transit time		45	10...240 s
		Control signal on/off	0		On/off control (Chap. 7.3.2)
	P13	Differential gap		5	2...10 °C
	P14	Minimum activation time		120	0...600 s
	P15	Minimum deactivation time		120	0...600 s
F 5		Automatic clock reset summer time/winter time	1 0	1	Active Not active
F 6		Subfloor drying	1		Active (Chap. 7.7)
			0	0	Not active

P 3	Min. flow temperature		30.0	0.0...130.0 °C (Chap. 7.4)
P 4	Max. flow temperature		80.0	20.0...130.0 °C
P 5	Fixed set point Return flow temperature		50.0	20.0...90.0 °C (Chap. 7.5) Setting with code number
P6	Drinking water set point		55.0	20.0...90.0 °C (Chap. 7.6)
P8	Kp Return flow temp. limit.		1.0	0.1...50.0
P9	Tn Return flow temp. limit.		0	0...999 s

Measured temperatures

t1	Flow temperature	Press control knob = Flow set point (Chap. 7.13)
t2	Outdoor temperature	Press control knob = Delayed outdoor temperature
t3	Return flow temperature	
t4	Drinking water temperature	

Factory (default) settings in the user level

Time	10:00	00:00 to 23:59
Year	2001	2001 to 2050
Date	1.01	1.01 to 31.12
Heating time schedule daily or weekly	7:00 to 22:00	00:00 to 24:00
Reference value for room temperature	20.0	10.0 to 30.0
Set point for flow temperature	65.0	0.0 to 130.0
Reduced reference value for room temp.	17.0	10.0 to 30.0
Reduced set point for flow temperature	50.0	0.0 to 130.0
Outdoor temperature	Measured value	Press control knob = Delayed outdoor temperature

7. Description of the controller functions

The TROVIS 5432 Heating and District Heating Controller is designed to control the flow temperature in heating systems. The control is either weather-compensated using an outdoor or flow sensor, or based on a fixed set point for the flow temperature just using one flow sensor. The flow temperature is controlled so that the required room temperature is achieved.

When used as a district heating controller, the controller can limit the return flow temperature.

The connected sensors allow the controller to measure the respective temperatures which are transmitted to the central signal processing system.

Subsequently, the system issues a control signal corresponding to the preset set points to operate the control valve and a binary signal for the heating circulation pump.

If a sensor for the drinking water temperature TS is connected, the drinking water priority is automatically activated.

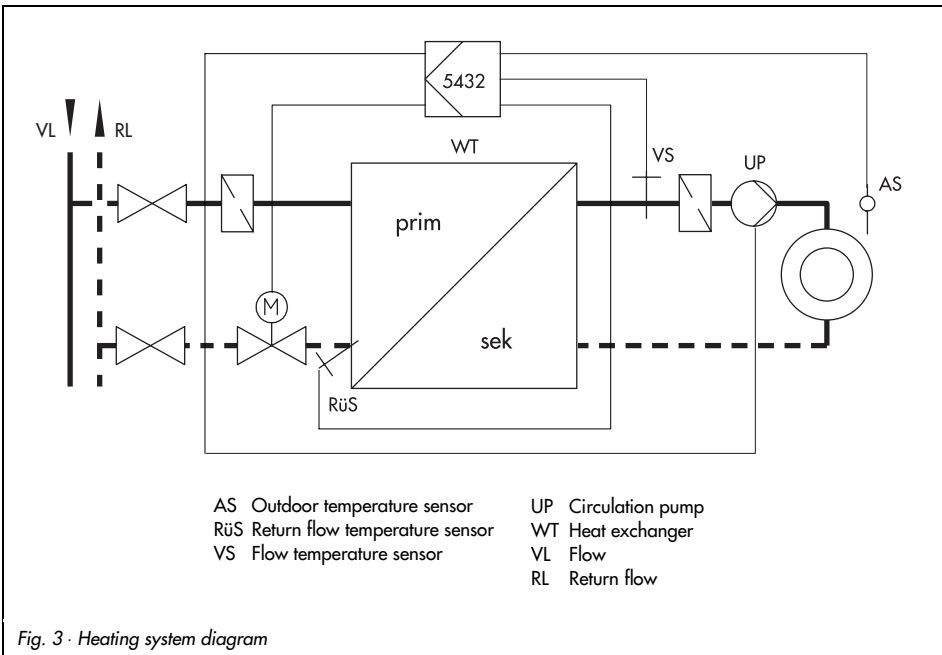

7.1 Operating modes

7.1.1 Weather-compensated control

Set the function block F1 to 1 = ON, and set the parameter P1 = Heating characteristic gradient and P2 = Level. Sensors AS and VS for outdoor and flow temperatures are required.

When the weather-compensated control is active, the reference value for room temperature appears in the display. The heating control works towards the temperature shown in the display in the room/house/apartment.

The reference value for room temperature allows you to influence the set point of the flow temperature that is calculated in the controller.

The set point of the flow temperature is calculated as a function of the heating characteristic gradient, the outdoor temperature and the reference value for room temperature.

Note:

The current reference value for room temperature can be briefly changed in the display level, it remains activated until the next time-of-use or time of non-use comes into effect.

See chapter 5.1 on setting.

7.1.1.1 Heating characteristic

The flow temperature is a function of the outdoor temperature. This correlation is described with the aid of the heating characteristic (Fig. 4).

Using the parameters "Gradient" and "Level" the heating capacity can be adapted to the building characteristic or to the type of heating (e.g. underfloor heating).

Gradient:

Depending on the set gradient of the heating characteristic, a varying high flow temperature is controlled for a outdoor temperature.

The gradient of the heating characteristic can be adjusted over the parameter P1 in the range of (0.2...3.2). The parameter P1 can be accessed on the installation level and has the default setting of 1.6. The left graph in Fig. 4 shows a selected group of heating characteristics with gradients in the range of P1 = (0.4...3.2).

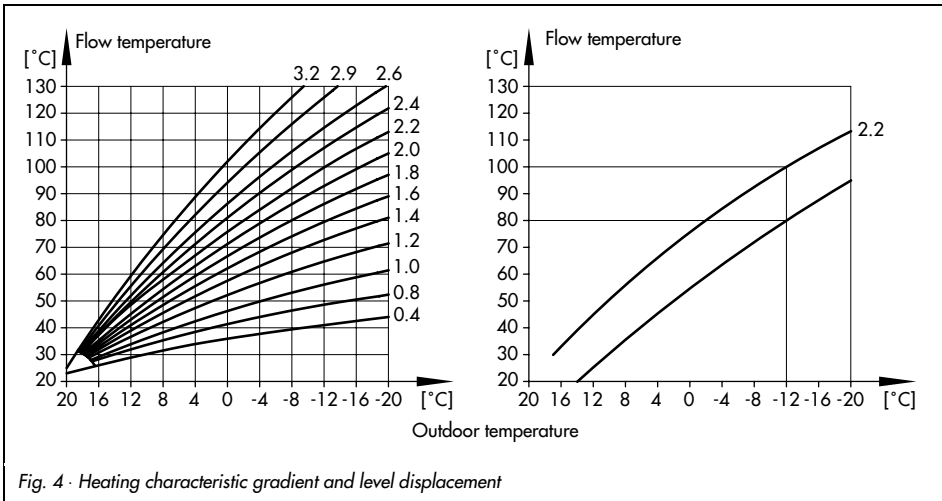

Fig. 4 - Heating characteristic gradient and level displacement

Level:

In addition to the gradient, the level of the heating characteristic can be lowered or raised by $\pm 30^\circ\text{C}$ using the parameter P2. This parameter provides you with a further option to adapt the heating to your individual requirements. The parameter P2 can be accessed on the installation level and has the default setting of 0°C .

The right graph in Fig. 4 shows how the level displacement by -19°C effects a heating characteristic with a gradient of 2.2.

7.1.2 Fixed set point control

Set the function block F1 to 0 = OFF.

A sensor VS for the flow temperature is required.

When the fixed set point control is selected, the set point of the flow temperature appears on the left-hand side of the display and the actual value of the flow temperature appears on the right-hand side.

The default set point for rated operation (time-of-use) is 65°C and for reduced operation (time of non-use) 50°C .

Note: The current flow temperature set point can be briefly changed on the display level. It remains activated until the next time-of-use or time of non-use comes into effect.

See chapter 5.1 on setting.

7.2 Delayed outdoor temperature adaptation

*Set the function block F3 to 1 = ON and P7 = Delayed outdoor temperature adaptation
A sensor AS for the outdoor temperature is required.*

This function accounts for the fact that a building stores heat. Usually, short-term variations in outdoor temperature do not affect the room temperature.

The function makes sure that brief variations in outdoor temperature (e.g. warm winds) are not included in the flow temperature control.

If the outdoor temperature changes rapidly, this change is only taken into account to a certain degree. The change in outdoor temperature that is taken into account in the control is defined over the parameter P7 (Delayed outdoor temperature adaptation).

For example, if the outdoor temperature changes by 7 °C/hr, just a 5 °C/hr change is used for the control. This means, the calculated outdoor temperature changes more slowly than the measured outdoor temperature. This function also applies when the controller switches over to summer time operation.

The parameter P7 can be set in the range from 1 to 6 °C/hr. The setting of this parameter depends on personal preferences and the building characteristic. The default setting is 5 °C/hr.

7.3 Control signal

This setting determines whether the control signal is a three-step signal or on/off signal.

7.3.1 Three-step control

Set F4 to 1 = ON and P10 = Kp Gain, P11 = Tn Reset time and P12 = Ty Actuator transit time.

The function of the three-step control has proportional plus integral action (PI controller).

Over the parameters P10 (gain factor Kp) and P11 (reset time Tn) the behavior of the control loop can be influenced.

With the aid of parameter P12, the transit time of the control valve (Ty) is taken into account in the algorithms. The control signal issuing is limited to three times of the duration of the control valve transit time (3 x Ty).

Note: If Tn = 0 is set, the controller functions only as a P controller.

7.3.2 On/off control

Set $F4$ to 0 = OFF and $P13$ = Differential gap, $P14$ = Minimum activation time and $P15$ = Minimum deactivation time.

The controller issues a control signal OPEN (+) and CLOSE (-). The switching characteristic is determined by selecting the differential gap. Unnecessary cycles can be avoided by specifying the minimum activation and deactivation time.

7.4 Limitation of the flow temperature

Set $P3$ = Minimum flow temperature and $P4$ = Maximum flow temperature

You can enter a maximum and minimum flow set point to limit the flow temperature.

The parameter $P3$ limits the flow temperature to a minimum and can be set between 0 and 130 °C. The default setting is 30.0 °C.

The parameter $P4$ limits the flow temperature to a maximum and can be set between 20 and 130 °C. The default setting is 80.0 °C.

In the following example, the maximum flow temperature is limited to 90 °C in weather-compensated control, while the minimum flow temperature is limited to 45 °C. When the flow temperature exceeds or fall belows the limit value, just the limit value is used for the control, i.e. the outdoor temperature in these ranges has no effect on the control.

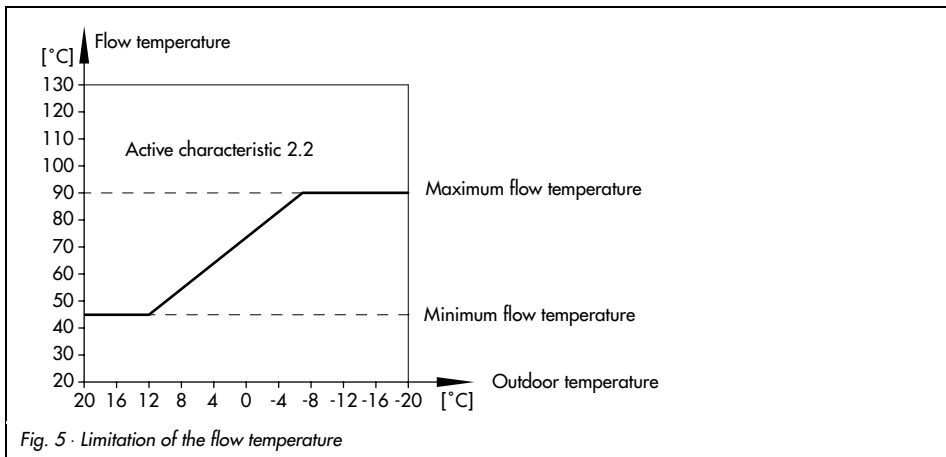

Fig. 5 · Limitation of the flow temperature

7.5 Limitation of the return flow temperature

Setting with P5 = Fixed set point of return flow temperature, P8 = Kp Gain and P9 = Tn Reset time.

This function is automatically activated when the sensor RüS for the return flow temperature is connected.

The return flow temperature is limited to a fixed set point. The parameter P5 used for this function is protected by a code number!



After selecting the parameter P5, you must first set the code number 1732 and acknowledge it, following this, you can change the parameter P5.

A PI algorithm exists for the limitation function. The integral-action component (parameter P9) is set to zero in the default setting.

7.6 Drinking water priority

Set drinking water set point using the parameter P6 .

The function is automatically activated when the sensor TS for the drinking water temperature is connected.

If the temperature measured at the drinking water sensor TS falls below the limit value (parameter P6) by more than 5 K for longer than 5 minutes, the power consumption of the heating circuit is reduced. For this purpose, the set point for the flow temperature is reduced gradually in increments of 5 K. The flow temperature can be reduced down to the value set in P3 "Minimum flow temperature".

- ▶ The set point is reduced by 5 K if the flow temperature of the heating circuit is below its set point when drinking water heating starts.
- ▶ The current set point of the heating circuit is retained if the charging temperature measured at the drinking water sensor TS is 5 K lower than its set point.
- ▶ The heating circuit set point is raised if the charging temperature measured at the drinking water sensor TS exceeds its set point.

You can set the limit value (parameter P6) between 20.0 and 90.0 °C. Its default setting is 55 °C.

7.7 Subfloor drying

Set F6 to 1 = ON

Anhydrite and cement plaster floors (wet screed) must be heated prior to laying a floorcovering (DIN norm 4725, Part 4).

The first heating up starts with a flow temperature of 25 °C. This temperature is kept constant for three days. After this, the maximum flow temperature is set as the set point. This maximum flow temperature is used for a further four days.

After the screed drying is completed, the controller automatically deactivates the function (F6= 0)

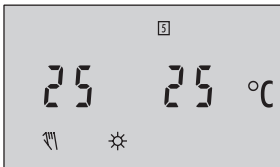

Display:

When the "Subfloor drying" function is activated, the set point appears on the left-hand side of the display and the actual value of the flow temperature appears on the right-hand side of the display.

Note: Any change during operation resets the function.

7.8 Heating deactivation during the time-of-use (rated operation)

Should the outdoor temperature exceed the current reference value for room temperature by 1°C, the heating is deactivated. To achieve this, the control valve closes and the circulation pump is deactivated after 3 minutes.

7.9 Heating deactivation during the time of non-use (reduced operation)

During times of non-use, the heating circuit operates with a reduced reference value for room temperature.

Should the outdoor temperature exceed the current reference value for reduced operation by 1°C, the heating is deactivated. To achieve this, the control valve closes and the circulation pump is deactivated after 3 minutes.

7.10 Manual operation

Set F2 to 1 = ON

Manual operation is carried out as stipulated in DIN EN 12098-1. The circulation pump is activated.

The controller does not issue a control signal in either on/off control or three-step control for the heating circuit's control valve.



Display:

Depending on the operating mode, the reference value for room temperature or flow temperature set point appears in the display.

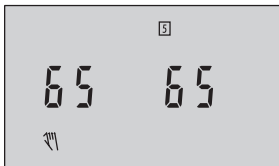

Note: The frost protection function is not activated when the controller is in manual operation.

7.11 Pump seizure protection

If the circulation pump has not been activated within 24 hours, it is force-operated by the controller at 12:00 hrs for one minute.

7.12 Defective sensors

In the event of a defective sensor, the malfunction symbol starts to blink in the display.

Defective or missing sensor:

For three-step control:	The control valve is closed completely and then opened to 1/3 over the control valve transit time.
For on/off control:	The controller controls the on/off output in 30 minute intervals as long as the minimal activation time lasts (P14).
Missing:	
Flow sensor VS:	As described above
Outdoor sensor AS	With fixed set point control, no effect, only display possible With weather-compensated control, the maximum set point set for the flow temperature is controlled.
Return flow sensor Rüs:	No limitation of the return flow temperature
Drinking water sensor TS:	No reverse control possible in conjunction with a self-operated regulator

7.13 Actual values

The actual values can only be displayed when the sensors are connected and the measured values are within the measuring range.

No symbols that are assigned to the actual values appear in the display.

On the user level, the measured outdoor temperature appears in the display as the last point.

On the installation level, the actual values can be viewed in the following sequence:

- f1 Flow temperature
- f2 Outdoor temperature
- i3 Return flow temperature
- t4 Drinking water temperature

8.2 Electrical connections



For wiring and connection of the controller, you are required to observe the VDE regulations and the regulations of the local power supply company. For this reason, this type of work must be carried out by a specialist.

8.2.1 Installation recommendations

These recommendations are intended as a guide to help you to set up the heating system optimally and to increase its efficiency. SAMSON assumes no responsibility or liability for any incorrect specifications.

▶ **Electric cables**

Use a separate cable for the power supply (230 VAC, 50 Hz) to the controller. This prevents interference of the power supply on the signal lines.

▶ **Signal lines**

Use shielded cables for the signal lines. This improves the quality of the signal transmission concerning interference. The shield needs only be grounded on one side at the inlet or outlet of the control cabinet (contact over a large area). The central grounding point must be connected to the grounding conductor PE using a copper wire ($>10 \text{ mm}^2$). To prevent any damage to the cables, we recommend you use a sufficiently thick cable ($\geq 0.75 \text{ mm}^2$).

▶ **Avoid interference**

The power supply cables must be laid separately from the signal lines. The distance between the cables must be at least 10 cm. This can be achieved in a simple and effective manner by just laying the power supply and signal cables in separate cable ducts. Inside the control cabinet, the power supply cables and signal lines must run separately. We do not recommend leading or terminating the signal lines in a control cabinet where high field strengths can occur. High field strengths are caused, for example, by power transformers or frequency converters. In the case that high field strengths are unavoidable, we recommend such devices should be shielded using separating panels from the signal lines. Use separating panels that have good chassis ground. Inductances in the control cabinet, e.g. contactor coils, must be equipped with suitable interference suppressors.

► **Surge protection**

The following measures must be taken to protect the controller from overvoltage if signal lines are installed outside of buildings or over long distances.

The shield of signal lines routed outside of buildings must have current carrying capacity and must be grounded on both sides. The surge diverters must be installed at the inlet of the control cabinet.

8.3 Connecting the controller

Connect the controller on the basis of terminal diagram in Fig. 7.

For the cable entries, knock out the grommets on the bottom of the casing base or insert the enclosed grommets.

Use a cable with a cross-section of min. 1.5 mm² for the power supply connection.

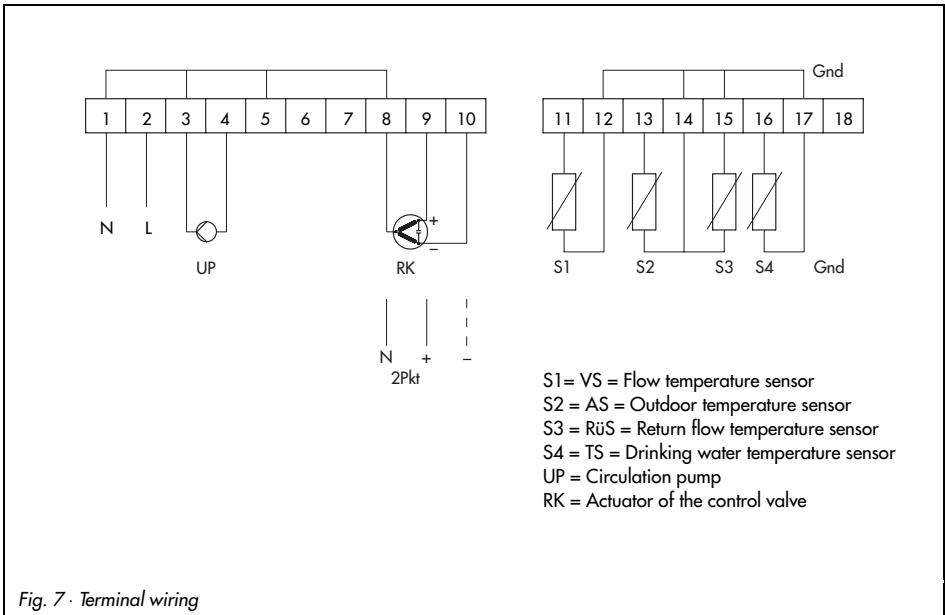

Fig. 7 · Terminal wiring

8.4 Connecting the sensors

Connect cables with a cross-section of min. $2 \times 0.5 \text{ mm}^2$ to the terminals of the controller.

8.4.1 Pt 1000 sensor values

°C	-35	-30	-25	-20	-15	-10	-5	0	5	10
Ohm	862.5	882.2	901.9	921.6	941.2	960.9	980.4	1000.0	1019.5	1039.0
°C	15	20	25	30	35	40	45	50	55	60
Ohm	1058.5	1077.9	1097.3	1116.7	1136.1	1155.4	1174.7	1194.0	1213.2	1232.4
°C	65	70	75	80	85	90	95	100	105	110
Ohm	1251.6	1270.7	1289.8	1308.9	1328.0	1347.0	1366.0	1385.0	1403.9	1422.9
°C	115	120	125	130	135	140	145	150		
Ohm	1441.7	1460.6	1479.4	1498.2	1517.0	1535.8	1554.5	1573.1		

8.5 Connecting the actuator

Connect the cable (suitable for damp locations) with a cross-section of min. 1.5 mm^2 to the terminals of the controller output.

Following this, we recommend that you check the operating direction and the correct connection (polarity) of the actuator.

For this purpose, after you have connected the power supply, increase the reference value for room temperature considerably for a short period. This should lead the controller to open the heating valve with its OPEN control signal (+). When the reference value is reduced, the heating valve should close with the CLOSE control signal (-).

8.6 Connecting the pump

Connect the cable with a cross-section of min. 1.5 mm^2 to the terminals of the controller.

9. Technical data

Inputs 4 sensor inputs Pt 1000 for	Flow temperature Outdoor temperature Return flow temperature Drinking water temperature
Outputs Control signal y Binary output	Three-step signal: load: 20 to 250 V AC; 0.3 A AC On/off signal: load: 20 to 250 V AC; 0.3 A AC 1 output for pump control, non-floating: 230 V AC, 2 A AC ($\cos \varphi > 0.5$)
Power supply	230 V AC (+10 %/ -15 %), 48 to 62 Hz, Power consumption approx. 1 VA
Ambient temperature Operation Transportation and storage	0 to 50 °C -10 to 60 °C
Degree of protection	IP 40 according to IEC 529
Class of protection	I according to VDE 0106
Degree of contamination	2 according to VDE 0110
Overvoltage category	II according to VDE 0110
Humidity rating	F according to VDE 40040
Noise immunity	According to EN 50082 Part 1
Noise emission	According to EN 50081 Part 1
Weight	Approx. 0.4 kg

Quick guide

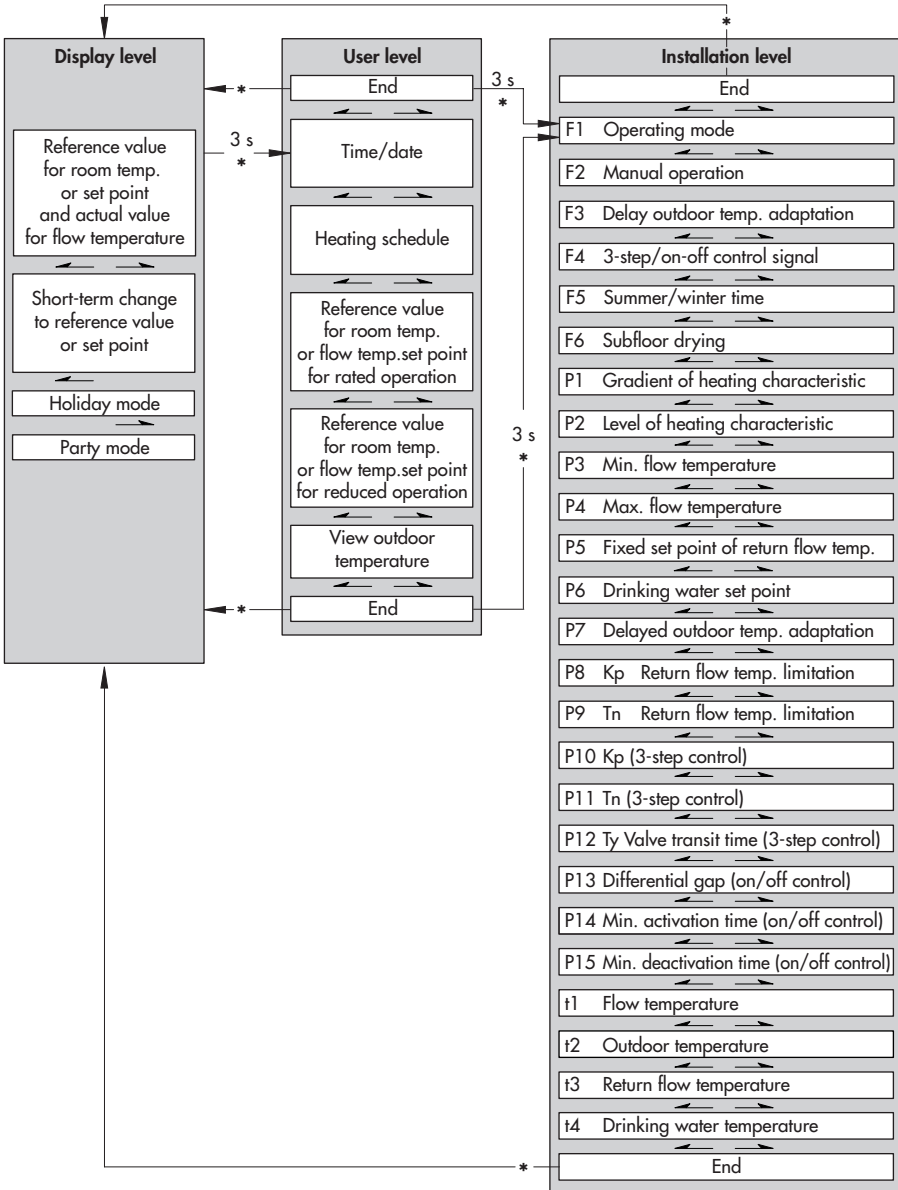



SAMSON AG · MESS- UND REGELTECHNIK
Weismüllerstraße 3 · D-60314 Frankfurt am Main · Germany
Phone +49 69 4 00 9-0 · Fax +49 69 4 00 9-15 07
Internet: <http://www.samson.de>

EB 5432-1 EN

S/C 2001-11