

Type 5757-7 Controller with Electric Actuator



Applications and Configuration

Note! The warnings and safety instructions specified in the Mounting and Operating Instructions EB 5757-7 EN apply to mounting, electrical connection and operation.

Scope of application

The Type 5757-7 Controller with Electric Actuator is suitable for installations in small to medium-sized buildings for outdoor temperature compensated control, fixed set point control or control with a reference variable (room temperature).

Sectional drawing

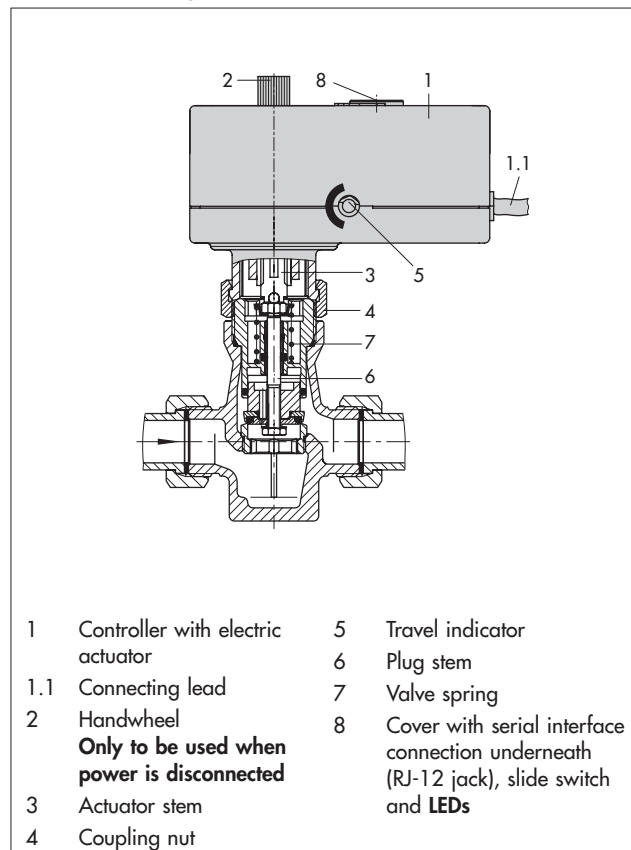

Attachment

The controller with electric actuator may not be installed in a suspended position.

Ready for operation

As soon as the device is connected to the power supply, the initialization procedure starts. The actuator stem extends and the red and yellow LEDs are illuminated.

When the actuator stem has reached the final position, the red LED is turned off. The yellow LED remains illuminated and indicates that the actuator is ready for operation.

Using the memory pen

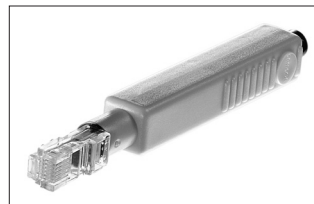

Order no. 1400-9753

Data are transferred between the memory pen and device at the serial interface (RJ12 jack underneath the cover (8)).

- **Command mode:** While the actuator is in closed loop operation, the memory pen can be used to transfer the device to the command mode. The actuator stem is extended or retracted depending on the command saved in the memory pen. After removing the memory pen from the actuator, the device returns to normal operation.

- **Data transmission:** After inserting the memory pen into the actuator, the data are transferred depending on how the memory pen has been configured:

(A) Automatically write to memory pen

- Function: All actuator data are uploaded onto the memory pen (settings #1 and #2).

– Blinking pattern of yellow LED:

On		Time [s]
Off		

(B) Automatically read from memory pen

- Function: All data in the memory pen are downloaded into the actuator (settings #1 and #2). Any existing settings are overwritten.

– Blinking pattern of yellow LED:

On		Time [s]
Off		

(C) Copy function

After function (A) has been completed, the memory pen is automatically reconfigured to perform function (B) to allow data on the memory pen to be copied to other Type 5757-7 Actuators in the same version.

- **Data logging:** The memory pen logs the operating data. Data logging finishes when the memory capacity of the memory pen is full.

– Blinking pattern of yellow LED:

Data logging is being prepared	On		Time [s]
	Off		

Data logging in progress

On		Time [s]
Off		

Note: If a memory pen, which is empty or containing data from another version of the same type of actuator, is inserted into an actuator, data are uploaded onto the pen regardless of the read/write status of the memory pen.





Faults

An illuminated red LED indicates a fault in the actuator.

A sensor cable breakage is indicated by the red LED blinking.

Each sensor is assigned a different blinking sequence.

When several sensors malfunction, the fault with the highest priority is indicated first (highest priority = flow sensor).

Sensor	Blinking pattern
Flow sensor	On  Time [s] Off
Outdoor sensor/ room sensor	On  Time [s] Off
Return flow sensor	On  Time [s] Off
Potentiometer	On  Time [s] Off

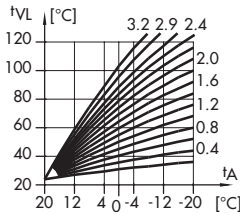
Function	Explanation	Customer data
	Note: A function is activated when the setting of the function blocks (F) is consistent with the specifications listed under "Customer data".	
Control principle	The controller with electric actuator functions with a PI algorithm (three-point stepping control). The valve reacts to pulses, which the electric actuator receives from the integrated digital controller when a system deviation occurs. The length of the first pulse, in particular, depends on the system deviation and the selected gain K_p <i>flow temperature control</i> (P09) (the length of the pulse increases, the larger the K_p gets). The length of the pulses as well as the interval between them changes until the system deviation is at zero again. The interval between individual pulses is influenced by the reset time T_n <i>flow temperature control</i> (P10) (the interval rises as T_n rises). The valve transit time T_y <i>actuator transit time for valve travel</i> (P11) reflects the time that the valve needs to move through its travel range from 0 to 100 % without stopping. Its default setting is optimally tuned in this device and therefore should not be changed ($T_y = 24$ s). The <i>Dead band</i> (P12) determines the reaction to the controlled state, i.e. the actuator is not active if the controlled variable moves within the dead band.	P09 [-] P10 [s] P11 [s] P12 [%]
Fixed set point control		
	The flow temperature is controlled to a fixed value. The following parameters are used as the reference variable: <ul style="list-style-type: none"> • <i>Flow temperature set point</i> (P01) in rated operation and • <i>Flow temperature set point</i> (P01) – <i>Flow temperature set-back in reduced operation</i> (P02) in reduced operation 	F01 - 0 P01 [°C] P02 [K]
Control with reference variable (room temperature) (connected to Type 5257-7 Room Panel) Note: The function is not active with setting P22 = 0.	The predetermined <i>Flow temperature set point</i> (P01) is influenced by the room temperature: The heat supply is matched to the required amount over a permanently active flash adaptation. This is achieved by comparing the room temperature at regular <i>Time intervals</i> (P22) with the room temperature set point valid for the current operating mode (rated or reduced operation): <ul style="list-style-type: none"> • <i>Room temperature limit at rated operation</i> (P19) • <i>Room temperature limit at reduced operation</i> (P20) The flow temperature is raised based on the <i>Flow temperature set point</i> (P01) when it falls below the valid room temperature set point. The heating is switched off when the room temperature exceeds the room temperature set point by the amount in <i>Maximum room temperature boost for deactivation</i> (P21). When the flow temperature falls below 15 °C, frost protection measures are started, i.e. the circulation pump is switched on and the flow temperature is regulated to 20 °C.	F01 - 1 F02 - 1 F05 - 1 F06 - 0 P19 [°C] P20 [°C] P21 [K] P22 [min] P23 [min]
Outdoor temperature compensated control		
	The flow temperature set point is determined in rated operation depending on the outdoor temperature by using a heating characteristic stored in the controller. By varying the <i>Gradient</i> (P05) and <i>Level</i> (P06) parameters, the characteristic can be adapted to individual requirements. In reduced operation, the flow temperature is reduced by the amount set in <i>Flow temperature setback in reduced operation</i> (P02). The <i>Maximum flow temperature</i> and <i>Minimum flow temperature</i> parameters (P03/04) limit the flow temperature range. When the outdoor temperature falls below 3 °C, frost protection measures are started, i.e. the circulation pump is switched on and the flow temperature is regulated to 20 °C.	F01 - 1 F02 - 0 P02 [K] P03 [°C] P04 [°C] P05 [-] P06 [K]
Summer mode	Should the outdoor temperature exceed the <i>Outdoor temperature limit value (rated operation/reduced operation)</i> (P17/18), the controller switches off the heating, i.e. the valve is closed and the circulation pump is switched after the <i>Pump lag time</i> (P23) has elapsed. The heating is switched on again when the outdoor temperature falls below the set point.	P17 [°C] P18 [°C] P23 [min]

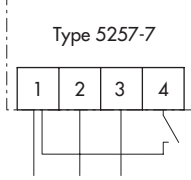
Function	Explanation	Customer data
Heating characteristic gradient shift	The potentiometer input changes the heating characteristic gradient. The range that can be changed is determined by the <i>Gradient shift range via potentiometer</i> (P07) parameter. The mid-position of the relevant potentiometer is also the zero position. Example: <i>Heating characteristic gradient</i> (P05) = 1.6 <i>Gradient shift range via potentiometer</i> (P07) = 1.0 → The gradient can be changed between 0.6 and 2.6.	F05 - 1 F06 - 0/1 F07 - 1 P07 [-]
Heating characteristic level shift	The potentiometer input changes the heating characteristic level. The range that can be changed is determined by the <i>Level shift range via potentiometer</i> (P08) parameter. The mid-position of the relevant potentiometer is also the zero position. The base level of the characteristic can be set by <i>Heating characteristic level</i> (P06). Example: <i>Heating characteristic level</i> (P06) = 0 K <i>Level shift range via potentiometer</i> (P08) = 15 K → The level can be changed between -15 K and +15 K. The limits for flow temperature (P03/04) still apply.	F05 - 1 F06 - 0/1 F07 - 0 P08 [K]
Change of operation modes		
Change rated oper. – OFF/frost protec. (BE1)	BE1 open: Rated operation BE1 closed: OFF/frost protection	F05 - 0 F08 - 0
Change rated oper. – reduced oper. (BE1)	BE1 open: Rated operation BE1 closed: Reduced operation	F05 - 0 F08 - 1
Change rated oper. – OFF/frost protec. (BE2)	BE2 open: Rated operation BE2 closed: OFF/frost protection	F11 - 0 F12 - 0
Change rated oper. – reduced oper. (BE2)	BE2 open: Rated operation BE2 closed: Reduced operation	F11 - 0 F12 - 1
Change by Type 5257-7 Room Panel	The operation mode of the controller is determined at the room panel: * Rated operation ☾ Reduced operation * OFF/frost protection	F05 - 1 F06 - 0
Change by binary input (BE) in Type 5257-7 Room Panel	When the mode switch is set to reduced operation or OFF/frost protection, the operation mode is changed by the binary input in the room panel. BE open: Operation mode is the same as set at the mode switch * Rated operation ☾ Reduced operation * OFF/frost protection BE closed: Rated operation	F01 - 1 F02 - 1 F05 - 1 F06 - 0
<p>Note: Terminals 1 to 4 are to be bridged with an external floating contact (e.g. by a timer with downstream contactor relay and with floating NO contact):</p> 		
Pump forced operation		
Note: The function is only active with F10 - 1.	A deactivated circulation pump is forced-operated every 24 hours for one minute.	F09 - 0 F10 - 1
Manual operating mode (over configuration)		
	In manual operating mode, the pump output (with F09 - 0) is switched ON. • With the setting F05 - 0, the actuator stem movement is controlled over binary input BE1: For direction of action increasing/increasing (F03 - 0) the following applies: BE1 closed Actuator stem retracts BE1 open Actuator stem extends • With the setting F05 - 1, the actuator stem movement is controlled over the connected potentiometer. For direction of action increasing/increasing (F03 - 0) the following applies: 0 % Actuator stem extends 100 % Actuator stem retracts	F13 - 1
<p>Note: The slide switch (underneath the cover (8)) can be used to change over into manual operating mode only if one level is used for control, provided the setting of F13 in levels #1 and #2 is not the same. The slide switch in position #1 points away from the device and towards the device in position #2.</p>		

A detailed list of all functions that can be configured in Type 5757-7 Controller with Electric Actuator can be found in the Mounting and Operating Instructions EB 5757-7 EN.

Summary of all functions and parameters

F	Function	Comment, [WE]
01	Control mode	0 – Fixed set point control [1] – Control with reference variable
02	Selecting the reference variable	[0] – Outdoor sensor 1 – Room sensor
03	Direction of stem action	[0] – Increasing/increasing >> 1 – Increasing/decreasing <<
04	Delayed outdoor temperature	[0] – Without delay 1 – With delay
05	Potentiometer input	[0] – Inactive, binary input BE1 active 1 – Active
06	Resistance range of potentiometer	[0] – Type 5257-7 Room Panel (1000 ... 1100 Ω) 1 – Type 5257-2 with remote adjuster (1000 ... 2000 Ω)
07	Function of potentiometer	[0] – Heating characteristic level shift 1 – Gradient shift
08	Function of binary input BE1	[0] – BE1 short-circuited: OFF/frost protect. 1 – BE1 short-circuited: Reduced operation
09	Function of switching output	[0] – BA as circulation pump control 1 – BA as heat demand
10	Anti-block protection of pumps	0 – No anti-block protection [1] – When pumps deactivated: switched on every 24 h for 1 min.
11	Return flow temperature sensor	0 – Inactive; Binary input BE2 active [1] – Active
12	Function of binary input 2	[0] – BE2 short-circuited: OFF/frost protect. 1 – BE2 short-circuited: Reduced operation
13	Manual mode	[0] – Inactive ¹⁾ [1] – Manual mode (absolute priority) ¹⁾ The default setting F 13 - 1 applies for level #2

P	Parameters	WE	Range
01	Flow temperature set point	70 °C	0...150 °C
02	Flow temperature set-back in reduced operation	15 K	0...50 K
03	Minimum flow temperature	20 °C	0...150 °C
04	Maximum flow temperature	120 °C	0...150 °C
05	Heating characteristic gradient	1.6	0.2...3.2
06	Heating characteristic level	0 K	-30...30 K
07	Gradient shift range via potentiometer	1.0	0.0...1.5
08	Level shift range via potentiometer	15 K	0...30 K
09	Kp flow temperature control	2.0	0.1...50.0
10	Tn flow temperature control	120 s	0...999 s
11	Ty actuator transit time for valve travel	24 s	10...240 s
12	Dead band (switching range)	2.0 %	0.5...5.0 %
13	Max. return flow temperature	50 °C	10...90 °C
14	Kp return flow temperature limitation	1.0	0.1...50.0
15	Tn return flow temperature limitation	400 s	0...999 s
16	Delayed time for outdoor temperature	3.0 °C/h	1.0...6.0 °C/h
17	Outdoor temperature limit at rated operation	22 °C	0...50 °C
18	Outdoor temperature limit at reduced operation	15 °C	0...50 °C
19	Room temperature set point at rated operation	20 °C	10...40 °C
20	Room temperature set point at reduced operation	15 °C	10...40 °C
21	Room temperature boost for switch-off	2 K	1...6 K
22	Time interval for flash adaption	10 min	0...100 min
23	Pump lag time	5 min	1...999 min

Applications and wiring plan

(bl = blue · br = brown · ye = yellow · gr = green · or = orange · blk = black · rd = red)
Terminals at the point of installation, not included in the scope of the delivery

Control with reference variable (room temperature) with flow sensor VS (Type 5267-2) and room panel RS (Type 5257-7)

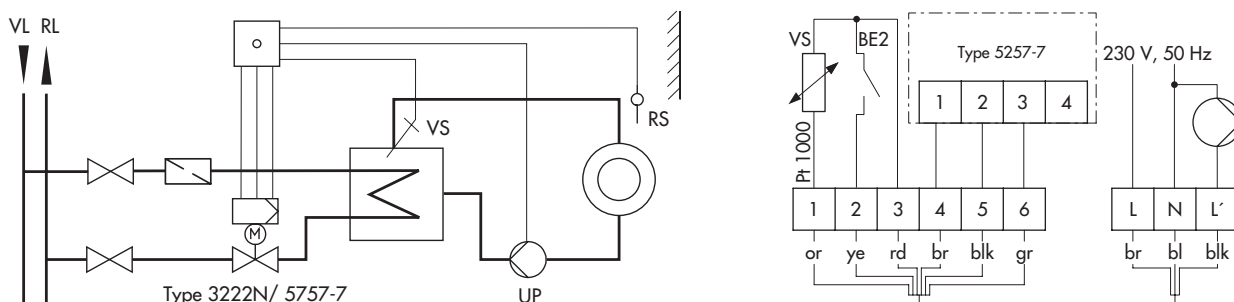

Outdoor temperature compensated flow control with flow sensor VS (Type 5267-2) and outdoor sensor AS (Type 5227-2)

