

Electropneumatic Converter for d.c. Current Signals

i/p Converter Type 6113



Application

i/p converters used to convert an electric d.c. current signal (i) into a standardized pneumatic signal (bar or psi). Especially suitable as an intermediate element between electric measuring equipment and pneumatic controllers or between electric control equipment and pneumatic control valves.

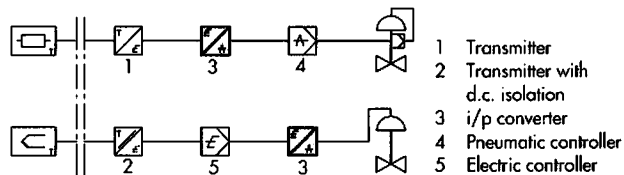

The input signal supplied to the i/p converter consists of a load-independent d.c. current i in the range 4 to 20 mA (0 to 20 mA) or 1 to 5 mA; the output signal consists of a standardized pneumatic pressure of either 0.2 to or 1.0 bar (3 to 15 psi) or 0.4 to 2 bar (6 to 30 psi) at a supply air pressure of either 1.4 bar (20 psi) or 2.4 bar (36 psi). The i/p converters are available in two versions: Mounting-rail units, for mounting on top hat rails, and field units (degree of protection IP 54).

Special features include:

- Extremely compact design
- Can be used as converters for control circuits or valve positioning
- Excellent dynamic response (critical frequency 9 Hz at 0.1 dm³ and 0.8 Hz at 1.0 dm³ connected volume), very insensitive to mechanical vibrations; for example, up to 160 Hz and 2 g in all directions, maximum influence < 0.5%
- Low input resistance and therefore low internal voltage drop
- Versions available with reverse characteristic or for split-range operation

Versions designed for non-hazardous areas

Type 6113-01 i/p Converter (Fig. 1) - Mounting-rail unit conceived for mounting on a top hat rail

Type 6113-02 i/p Converter (Fig. 2) - Field unit conceived for either wall or tube mounting; air connections with tapped hole connection NPT 1/4

Type 6113-03 i/p Converter - Basically the same as Type 6113-02 i/p Converter; however, air connections with tapped hole connection ISO 228 G 1/4

Versions designed for hazardous areas

Input circuit in type of protection EEx ia IIC

Type 6113-21 i/p Converter - Mounting-rail unit conceived for mounting on a top hat rail

Type 6113-22 i/p Converter - Field unit conceived for either wall or tube mounting; air connections with tapped hole connection NPT 1/4

Type 6113-23 i/p Converter - Basically the same as Type 6113-22 i/p Converter; however, air connections with tapped hole connection ISO 228 G 1/4

All field units are optionally available with stainless steel pressure gauges for measuring the output pressure with a scale 0 to 6 bar (0 to 90 psi)

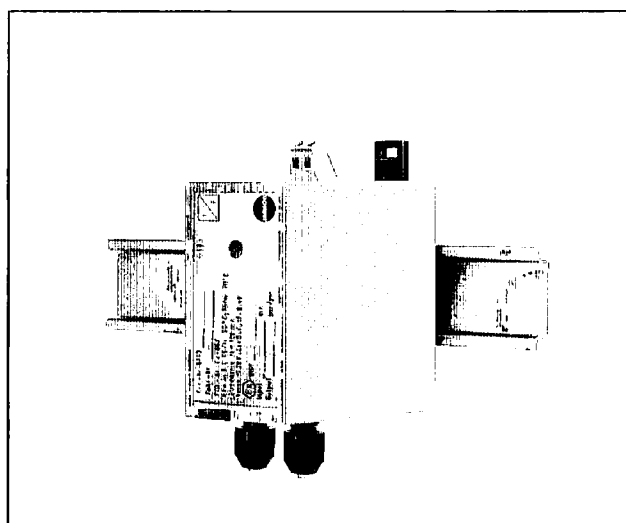

Fig. 1 · Type 6113-01 i/p Converter (mounting-rail unit)

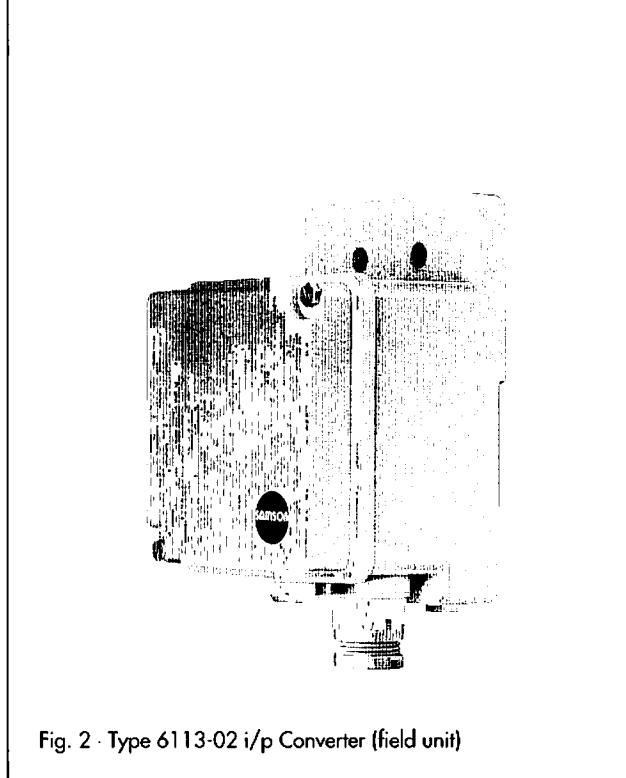

Fig. 2 · Type 6113-02 i/p Converter (field unit)

Special i/p converters:

Versions designed as plug-in units and versions for valve positioning with output signals up to 6 bar (90 psi) (see Data Sheet T 6102 E for details).

Principle of operation (Fig. 3)

The instrument basically consists of an i/p converter operating according to the force-balance principle and a connected amplifier.

The d.c. current i , supplied via the terminals (16), flows through the plunger coil (2) located in the field of the permanent magnet (1).

At the balance beam (3), the force of the plunger coil, which is proportional to the d.c. current i , is balanced by the force of the back pressure, which produces the jet stream leaving the nozzle (6) on the flapper (7).

The amplifier (15) is supplied with air which flows through the restriction (8) and nozzle (6), where it hits the flapper (7). If the input current i and the associated force of the plunger coil increase, the flapper (7) moves closer to the nozzle (6). As a result, the back pressure and, consequently, also the pressure p_a supplied to the amplifier (15) increase. This pressure continues to increase until a new state of equilibrium is attained and the pressure p_a is proportional to the current i .

The connected amplifier (15) amplifies the supply air of the i/p converter and then delivers, depending on the version, an output pressure (p_a) from 0.2 to 1.0 bar (3 to 15 psi) or 0.4 to 2 bar (6 to 30 psi).

i/p converter for mounting-rails

The enclosures of the mounting-rail units (Fig. 1) are designed for mounting in control rooms or cabinets and are secured to 35 mm top hat rails according to DIN EN 50 022 (optionally available with mounting socket for 32 mm G-rails according to DIN EN 50 035).

i/p converters for field installation

The splash-proof enclosures of the field units illustrated in Fig. 2 are suitable for field installation.

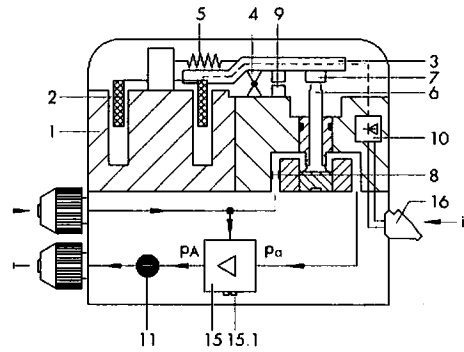

- 1 Permanent magnet
- 2 Plunger coil
- 3 Balance beam
- 4 Cross spring pivot
- 5 Spring
- 6 Nozzle with eccentric sleeve for span adjustment
- 7 Flapper
- 8 Restriction
- 9 Damping
- 10 Protective diodes
- 11 Restriction
- 15 Amplifier
- 15.1 Zero adjuster
- 16 Terminals for the electrical connection

Fig. 3 · Functional diagram of Type 6113 i/p Converter

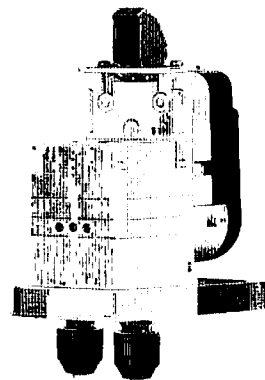

Fig. 4 · Type 6113-21 i/p Converter with intrinsically safe input circuit EEx ia II C (mounting-rail unit)

Summary of the approved explosion protection certifications for Types 420-1.

Certificate type	Certificate number	Date	Comments
Certificate of Conformity	PTB no. Ex-86.B.2106	06.08.1986	EEx ia II C T6
SEV certification	93.1 00906.01	03.09.1993	EEx ia II C T4 to T6

The test certificates can be found in the "Mounting and operating instructions" and are available on request.

Technical data

Type	Without explosion protection	6113-01 6113-02 6113-03 Input impedance 200 Ω ±7.5 % at 20 °C ³⁾	
	With explosion protection	6113-21 6113-22 6113-23 Input circuit intrinsically safe ⁴⁾ , Input impedance 200 Ω ±7.5 % at 20 °C ³⁾ , Effective inductance = 0 mH	
Input	4 to 20 mA, for split range 4 to 12 or 12 to 20 mA 0 to 20 mA, for split range 0 to 10 or 10 to 20 mA 1 to 5 mA		
Output	0.2 to 1 bar 3 to 15 psi		0.4 to 2 bar ¹⁾ 6 to 30 psi ¹⁾
	Air supply adjustable	at Q _{max} at Q _{min}	2.2 m _n ³ /h, min. connected volume > 0.05 dm ³ 0.5 m _n ³ /h, min. connected volume > 0.012 dm ³
Supply	1.4 ±0.1 bar (20 ±1.5 psi)		2.4 ±0.1 bar (36 ±1.5 psi)
	Power consumption		0.15 m _n ³ /h ²⁾
Characteristics		Characteristic: Output linear to input	
Hysteresis		< 0.1 % of upper range value	
Deviation from terminal-based linearity		< 0.3 % of upper range value	
Influence in % of upper range value		Supply: 0.2 %/0.1 bar ²⁾	
		Alternating load, supply failure, interruption of the input current: < 0.1 %	
Load characteristic		Ambient temperature: Lower limit of measuring range < 0.02 %/°C, span < 0.03 %/°C	
		±3 % at air supply ±0.4 m _n ³ /h ±3 % at air supply ±1.1 m _n ³ /h Reversal errors not detectable	
Dynamic response		With connected volume 0.1 dm ³	With connected volume 1 dm ³
Critical frequency		9 Hz	0.8 Hz
Phase displacement		-110°	-55°
Environmental conditions, degree of protection, weights			
Ambient temperature		-20 to +70 °C ⁴⁾	
Storage temperature		-30 to +80 °C	
Degree of protection		Mounting-rail units: IP 20 Field units: IP 54	
Weights (approximately)		Type 6113-.1: 0.32 kg, Type 6113-.2 and Type 6113-.3: 0.86 kg	

1) Not valid for input 1 to 5 mA

2) Measured at medium output pressure

3) Coil material Cu, T_K = 4%/10 K

4) Input circuit in type of protection "Intrinsically safe EEx ia II C".

See Certificate of Conformity for details (permissible temperatures, effective internal capacity and inductivity).

Electrical connection

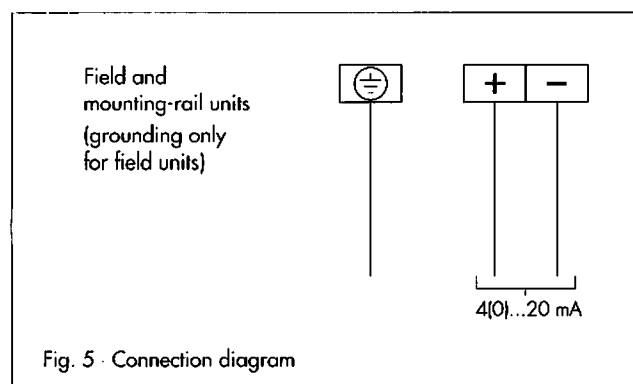

Ordering text

Type 6113-.. i/p Converter

d.c. current input signal ... mA, pneumatic output signal ... bar/psi

Operating direction: Direct (increasing-increasing) / reverse (decreasing-increasing)

Optionally available with pressure gauges

Special version optionally available for field units: Electrical connection with 1/2" US screwed gland

Type 6113-1 i/p Converter (rail-mounting unit)

For mounting on a 35 mm top hat rail according to DIN EN 50 022 (optionally, mounting socket for 32 mm G-rails, DIN EN 50 035)

Air connections: Tube connection for tube 4x1 (outside diameter 6 mm)

Electrical connection: Connection terminals for lines 0.5 to 2.5 mm²

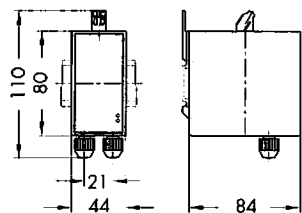

Type 6113-2 and 6113-3 i/p Converters (field units)

The Figs. below illustrate the mounting location of the converters.

The following types of mounting are provided:

Tube mounting – With clamp on either a horizontal or a vertical 2" tube

Wall mounting – With screws for mounting on a wall

Electrical connection: Via a stuffing box gland PG 13.5 (on request 1/2" US screwed gland), Connecting terminals for lines 0.5 to 2.5 mm²

Air connection: Type 6113-2; tapped hole connection NPT 1/4, Type 6113-3; tapped hole connection ISO 228 G 1/4

Tube mounting

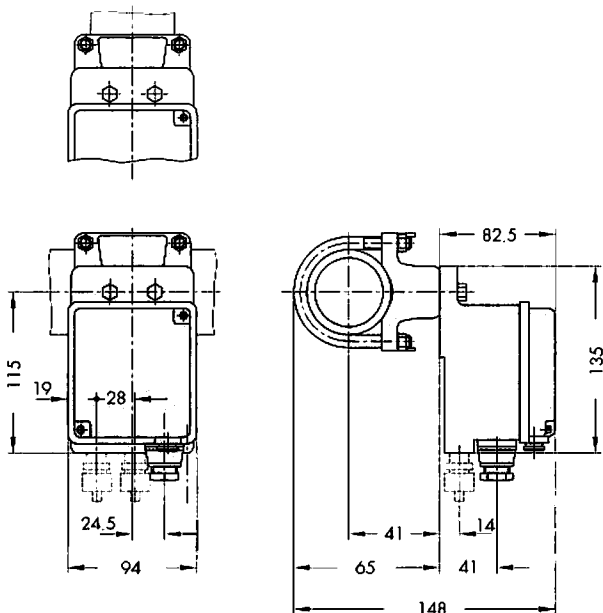

Wall mounting

