

Actuators

Pneumatic, electric and electrohydraulic actuators for control valves and butterfly valves



Diaphragm actuators up to 2800 cm²

Electric actuators up to 12.5 kN

Electrohydraulic actuator up to 7.7 kN

Hand-operated actuator

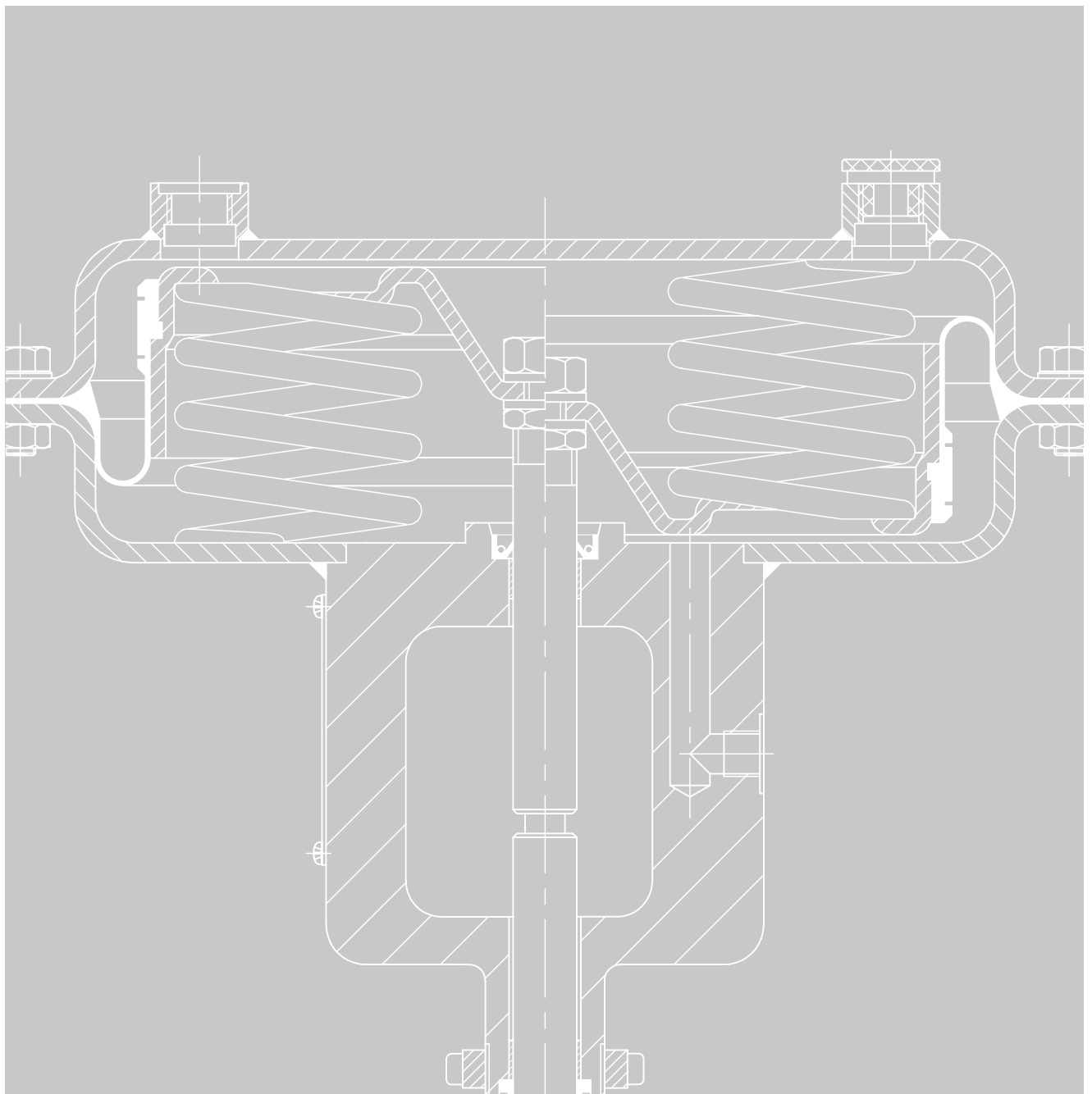

Selection and application

Actuators convert the control signal supplied by automation equipment (controller, control station, process control system) into a linear or rotary motion used to position the final control element (e.g. valve plug) in direct proportion to the control signal received. For control valves, this converted motion is a linear motion (upward or downward). For butterfly valves, ball valves and rotary plug valves, this is a rotary motion up to 70° opening angle for throttling applications. For on/off service, this is a rotary motion up to 90°. The actuator together with the valve constitute the entire control valve assembly, commonly referred to as the control valve.

To meet plant requirements, the actuators can be equipped with a wide range of transfer elements, such as positioners, converters, solenoid valves, position transmitters and limit switches. For details on selecting the additional equipment, refer to Information Sheet ▶ T 8350 EN.

Instrumentation

Pneumatic actuators are field-proven, require little maintenance, and are inexpensive.

Accessories, such as positioners and converters, also act as servo-boosters because they convert the low-volume output signal y (0.2 to 1 bar) received from a controller into a powerful signal pressure p_{st} up to 6 bar (90 psi).

Electric and electrohydraulic actuators are primarily used in applications where compressed air is not available. A series of modules can also be added to these actuators, permitting them to be adapted to the specific control task.

A Pneumatic instrumentation

A1

Instrumentation without positioner
Signal pressure range 0.2 to 1 bar (3 to 15 psi)

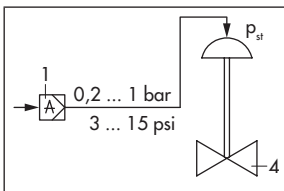

B Electropneumatic instrumentation

B1

Instrumentation with electropneumatic positioner
Signal pressure $p_{st} \leq 6$ bar (90 psi)

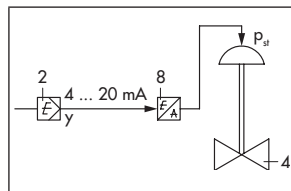

C Electric instrumentation

C1

Instrumentation with AC motor
230 V AC

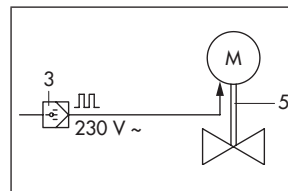

C3

Electrohydraulic actuator with three-step control

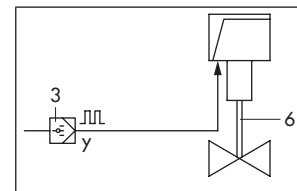

A2

Instrumentation with pneumatic positioner
Signal pressure $p_{st} \leq 6$ bar (90 psi)

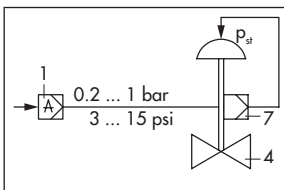

B2

Instrumentation with electropneumatic positioner
Signal pressure $p_{st} \leq 6$ bar (90 psi)

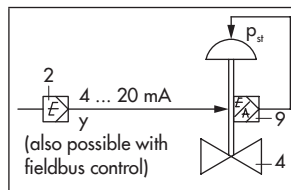

C2

Instrumentation with reversing contactor and three-phase AC motor
380 V AC

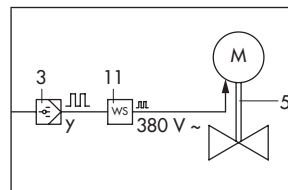

C4

Electrohydraulic actuator with continuous electric control signal

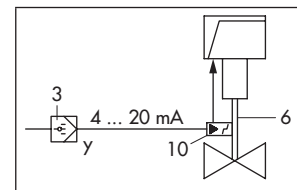

Legend for A1 to C4

- 1) Pneumatic controller
- 2) Electric controller or automation system with mA output
- 3) Electric controller or automation system with three-step output
- 4) Pneumatic control valve
- 5) Electric control valve
- 6) Electrohydraulic control valve
- 7) Pneumatic positioner
- 8) Electropneumatic converter
- 9) Electropneumatic positioner
- 10) Electric positioner
- 11) Reversing contactor

Pneumatic actuators

The pneumatic actuators are diaphragm actuators with rolling diaphragm and internal compression springs.

Benefits of pneumatic actuators:

- Designed for signal pressures up to 6 bar (90 psi)
- Low overall height
- Powerful thrust and high response speed
- Minimum friction
- Various bench ranges
- No special tools required to change the bench range or to reverse the operating direction of the actuator

Fail-safe action

Depending on the version, the actuators have two different fail-safe actions which become effective when the pressure is relieved from the diaphragm or the air supply fails:

Actuator stem extends (FA):

The spring force moves the actuator stem to the lower end position.

Actuator stem retracts (FE):

The spring force causes the actuator stem to retract.

Type 3271 Pneumatic Actuator (Fig. 1 and Fig. 2)

- For rated travels of 7.5 to 160 mm and diaphragm areas of 120, 175, 240, 350, 355, 700, 750, 1000, 1400 and 2800 cm²
- Tandem actuator with effective area of 2 x 2800 cm²
- Optional version fitted with handwheel on the diaphragm case for actuators with 120 to 700 cm² diaphragm areas (Fig. 1)
- 1400 to 2800 cm² diaphragm areas with side-mounted handwheel
- For more details, refer to Data Sheets ► T 8310-1 EN, ► T 8310-2 EN and ► T 8310-3 EN

Type 3277 Pneumatic Actuator (Fig. 3)

- Suitable for integral positioner attachment
- Diaphragm areas of 120, 175, 240, 350, 355, 700 or 750 cm²
- Rated travels from 7.5 to 30 mm
- Optionally with handwheel
- Refer to Data Sheet ► T 8310-1 EN

Type 3204-1 and Type 3204-7 Pneumatic Actuator with Rotary Lever (Fig. 4)

- Pneumatic diaphragm actuators for final control elements with rotary closure members, particularly for butterfly valves and louvers (shutters)
- 350 or 700 cm² diaphragm areas
- Optionally with manual override
- Type 3204-7 Actuator suitable for integral positioner attachment
- Refer to Data Sheet ► T 8316 EN



Fig. 1: Type 3271 Pneumatic Actuator with additional handwheel and Type 3241 Valve

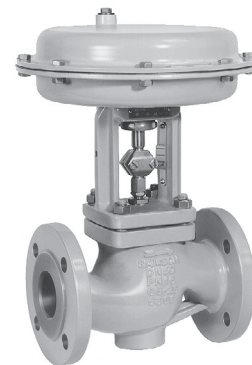

Fig. 2: Type 3271 Pneumatic Actuator and Type 3241 Valve

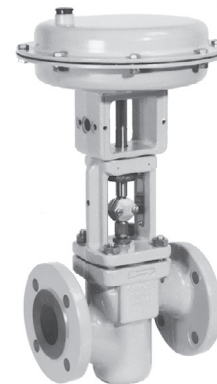

Fig. 3: Type 3277 Pneumatic Actuator and Type 3241 Valve

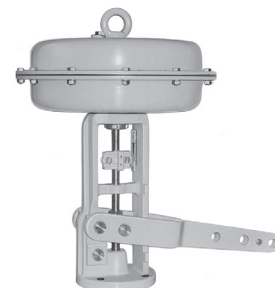

Fig. 4: Type 3204-1 Pneumatic Actuator with Rotary Lever

Type 3278 Pneumatic Rotary Actuator (Fig. 5)

- Single-acting rotary actuator with spring-return mechanism used for butterfly valves and other final control elements with rotary closure members
- 70° or 90° nominal opening angle
- 160 or 320 cm² diaphragm areas
- Optionally with manual override
- Refer to Data Sheet ► T 8321 EN

Pfeiffer Type 31a Pneumatic Rotary Actuator (Fig. 6)

- Single-acting or double-acting piston actuator for final control elements with rotary closure members
- 90° opening angle
- Optionally with additional manual override
- Suitable for throttling or on/off service
- Refer to Data Sheet ► T 9929 EN

Electric and electrohydraulic actuators

Type 3274-11 to -23 Electrohydraulic Actuator (Fig. 7)

- Thrust up to 7.7 kN and 15 or 30 mm rated travel
- Transit times of 60 s and higher for three-step control or with positioners for input signals from 0/4 to 20 mA or 0/2 to 10 V
- Optionally with electric or mechanical override
- Version with fail-safe action available
- Refer to Data Sheet ► T 8340 EN

Type SAM Electric Actuator (Fig. 8)

- Linear actuator with reversible motor with thrusts of 2 to 25 kN for rated travels from 15 to 120 mm
- Transit times of 30 s and higher for three-step control or with positioners for input signals from 0/4 to 20 mA or 0/2 to 10 V
- With mechanical override, two torque-dependent and three travel-dependent limit contacts
- Refer to Data Sheet ► T 8330 EN

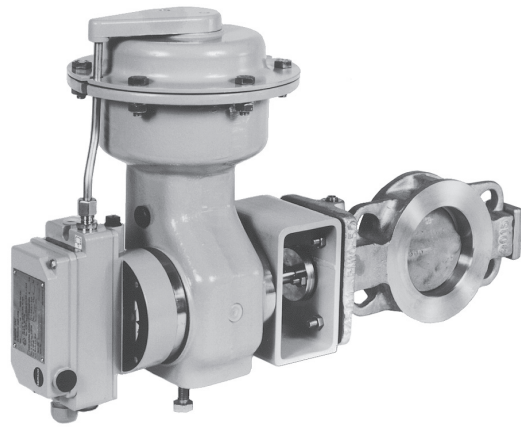

Fig. 5: Type 3278 Rotary Actuator with Type 3331 Butterfly Valve and Type 3767 Positioner



Fig. 6: Pfeiffer Type 31a Rotary Actuator



Fig. 7: Type 3274-... Electrohydraulic Actuator with electric override

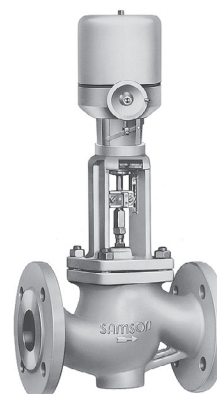

Fig. 8: Type 3241-2 Electric Control Valve with Type SAM Actuator

Type 3374 Electric Actuator (Fig. 9)

- Electric actuator for plant engineering and HVAC
- Thrust up to 2.5 kN
- Version:
 - With or without fail-safe action
 - For three-step control
 - With digital positioner
- Refer to Data Sheet ► T 8331 EN

Type 3375 Electric Actuator (Fig. 10)

- Electric actuator for plant engineering and HVAC
- Thrust up to 12.5 kN
- Version:
 - For three-step control
 - With digital positioner
 - Version with fail-safe action (in preparation)
- Refer to Data Sheet ► T 8332 EN

Hand-operated actuator

Type 3273 Hand-operated Actuator (Fig. 11)

- For attachment to valves used as hand-operated control valves
- Particularly suitable for attachment to Series 240, 250 and 260 Valves
- 15 to 30 mm rated travel · Nominal thrusts up to 32 kN
- Refer to Data Sheet ► T 8312 EN



Fig. 9: Type 3374 Electric Actuator



Fig. 10: Type 3375 Electric Actuator

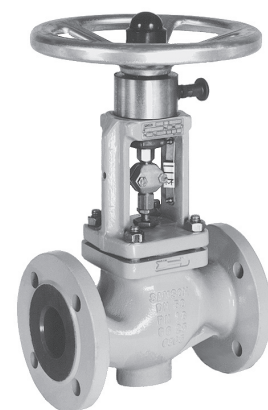

Fig. 11: Type 3273 Hand-operated Actuator mounted on Type 3241 Valve

Specifications subject to change without notice



SAMSON AG · MESS- UND REGELTECHNIK
Weismüllerstraße 3 · 60314 Frankfurt am Main, Germany
Phone: +49 69 4009-0 · Fax: +49 69 4009-1507
samson@samson.de · www.samson.de

T 8300 EN

2014-10-31 · English