

**Automation System TROVIS 5500
Programmable Logic Controller (PLC)
TROVIS 5571**



Mounting and Operating Instructions

EB 5571 EN

Firmware version 1.1x
Edition December 2007



Disclaimer of liability

We are constantly developing our products and therefore, reserve the right to change the product or the information contained in this document at any time without notice.

We do not assume any liability for the accuracy or completeness of these mounting and operating instructions. Moreover, we do not guarantee that the buyer can use the product for an intended purpose. SAMSON rejects any liability for claims by the buyer, especially claims for compensation including lost profits or any other financial loss, except the damage was caused intentionally or by gross negligence. If an essential term of the contract is breached by negligence, SAMSON's liability is limited to the foreseeable damage.

Safety instructions



- ▶ The device may only be assembled, started up or operated by trained and experienced personnel familiar with the product. Proper shipping and appropriate storage are assumed.
- ▶ The device has been designed for use in electrical power systems. For wiring and maintenance, you are required to observe the relevant safety regulations.

Contents	Page
1	Operation 4
1.1	Operating elements 4
1.1.1	Operating keys 4
1.2	Display 5
1.2.1	Adjusting the contrast of the display 6
1.3	Displaying data 7
1.4	Setting the system time 8
2	Start-up 10
2.1	Programming 10
2.2	Changing PLC settings 11
2.3	Configuring universal inputs 13
2.4	Resetting to default values 15
3	Manual operation 16
4	Operational faults 17
5	Communication 18
5.1	Modbus slave interface 18
5.2	Modbus master interface 20
5.3	Description of communication parameters to be adjusted 21
5.4	Meter bus interface 23
5.4.1	Activating the meter bus 23
5.5	Data logging module 25
5.5.1	Data logging 25
5.5.2	Saving and loading firmware and applications 26
6	Installation 27
7	Electrical connection 29
8	Appendix 32
8.1	Settings level 32
8.2	Technical data 34
8.3	Special key codes 35
8.4	Expansion modules 35
8.4.1	Technical data 35
8.4.2	Terminal assignment 36
8.4.3	Integrating the expansion modules 37
8.5	Sensor resistance tables 38
8.6	Customer data 39

1 Operation

The programmable logic controller (PLC) is freely programmable. The controller is delivered **without** an executable application in the memory. The application must be developed separately for the desired purpose on a personal computer using ISaGRAF® (programming as in IEC 61131-1) and then transferred to the controller.

On start-up, after transferring the generated application, the **current time and date** must be set in the controller (→ section 1.4).

1.1 Operating elements

1.1.1 Operating keys

The keys are located in the front panel of the PLC and protected by a Plexiglas door.



Changeover key

(press with pen or other pointed item)

Switch between levels (after entering the key code)



Reset key

(press with pen or other pointed item)

Reset freely accessible parameters and function blocks to their default values (factory settings)



Cursor key(s)

⬆️⬇️ Pressing both keys together:

– Switch to information level

⬇️ Pressing one of the keys separately:

– Navigate in levels (also in the application developed with ISaGRAF®)

– Set data points



Enter key

– Open levels (also in the application developed with ISaGRAF®)

– Activate editing mode for parameters and function blocks

– Confirm entered settings



1.2 Display

The programmable logic controller has a **plain text display**.

The display is automatically illuminated when entering or setting the controller.

After connecting the controller to the power supply, "System is being initialized..." appears briefly on the display.





























Should the display not be illuminated or the contrast is too strong/weak, you can adapt the display illumination. Refer to section 1.2.1.

28.11.2005	10:00:05	V1.1.x
Application: ...		
Version: ...		
Date: ...		
CRC: ...		
Size: ... kB		
Cycle time: ... ms		
 --	 --	 --

If an application is not saved on the PLC, the normal display (left) contains the date, time and current firmware version.

If an application is saved on the PLC, the normal display contains application-related information.

The current status of the three communication interfaces "RS-232/Slave", "RS-485/Master" and "RS-232/Prog" appears at the bottom of the display:

RS-232/Slave (left)		RS-485/Master (middle)		RS-232/Prog (right)	
 --	Interface inactive	 --	Interface inactive	 --	Interface inactive
  	Direct connection to control station active	  	Modbus master active	  	Connection to ISaGRAF® Workbench active
 --	Modem inactive			 	Data logging active
 -- blinking	Modem initialization active				
 	RING, calling active				
   blinking	Connection established/canceled				
  	Connection to control station active				
 ?	Error				
  	SMS sending active				

Note!

If no key is pressed for two minutes, the PLC returns to the normal display. The background illumination of the display is switched off automatically.

Any settings that have not been confirmed are not saved and must be re-entered.

1.2.1 Adjusting the contrast of the display

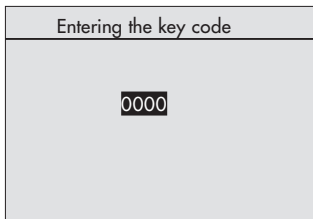

Activate the editing mode.

Display: Entering the key code

0000 blinks



Confirm the **0000** reading.



Set the contrast.



Confirm the changed setting.

Display: Normal display (depending on the application)

1.3 Displaying data

The states of the inputs and outputs as well as information on the connected meter bus instruments can be retrieved in the information level. In addition, the analog and binary outputs can be changed (refer to section 3 on manual operation).

The information level is divided into individual menu items:

- ▶ **Analog inputs** · Measured data from connected sensors
- ▶ **Analog outputs** · Output data from four analog outputs *)
- ▶ **Binary inputs** · States of the binary sensors (on/off)
- ▶ **Binary outputs** · States of the binary outputs (on/off) *)
- ▶ **Meter bus** · Output data of the meters connected over meter bus

*) The analog and binary output settings can be changed after entering the key code.

Proceed as follows:

Information level
Analog inputs
Analog outputs
Binary inputs
Binary outputs
Meter bus
System info
<i>Back</i>

- Switch to the information level.
Display: Information level
The menu item "Analog inputs" is highlighted.
- Select required menu item, e.g. binary outputs.
- Activate the menu item.
- Select required data point.

Binary outputs
BA07=OFF
BA08=OFF
BA09=OFF
BA10=OFF
BA11=OFF
BA12=OFF
<i>Back</i>

Returning to the information level

- Select *Back* to return to the information level.
- Exit the menu item.
Display: Information level

Information level
Analog inputs
Analog outputs
Binary inputs
Binary outputs
Meter bus
System info
<i>Back</i>

Exiting the information level

- Select *Back*.
- Exit the information level.
Display: Normal display (depending on the application)

Note!

If no key is pressed for two minutes, the PLC automatically returns to the normal display.

1.4 Setting the system time

The current time and date need to be set immediately after start-up and after a power failure lasting more than 24 hours.

Set the **system time** in the settings level under the menu item "Date / time". The **Automatic summer time** function can also be activated or deactivated in this menu item.

- ▶ **System time:** Time-dependent functions of the saved application are based on the system time set in the PLC.
- ▶ **Automatic summer time:** The summer time is automatically set on the last Sunday in March at 02:00 h and the winter time on the last Sunday in October at 03:00 h.

Proceed as follows:

Entering the key code	⇒	Activate the editing mode. Display: Entering the key code 0000 blinks
Settings level	⇩	Enter the key code.
Date / time RS-232/Slave RS-485/Master RS-232/Prog Meter bus Universal input type Back	⊗	Confirm the key code entered. Display: <u>Settings level</u> The "Date / time" menu item is highlighted.
Settings level	⊗	Activate the menu item "Date / time". Display: System time (DD.MM.YYYY HH:MM)
28.11.2005 10:00 RS-232/Slave RS-485/Master RS-232/Prog Meter bus Universal input type Back	⊗	Activate the editing mode for the system time. Display: Date (DD) blinks.
	⇩	Enter date.
	⊗	Confirm date entered. Display: Month (MM) blinks.

Settings level
Automatic summer time? On
RS-232/Slave
RS-485/Master
RS-232/Prog
Meter bus
Universal input type
Back

Settings level
28.11.2005 10:00
RS-232/Slave
RS-485/Master
RS-232/Prog
Meter bus
Universal input type
Back

Settings level
Date / time
RS-232/Slave
RS-485/Master
RS-232/Prog
Meter bus
Universal input type
Back

- ⏴ Enter month.
- ⊗ Confirm month entered.
Display: Year (YYYY) blinks.
- ⏴ Enter year.
- ⊗ Confirm year entered.
Display: Time (HH) blinks.
- ⏴ Enter hour.
- ⊗ Confirm hour entered.
Display: Minutes (MM) blink.
- ⏴ Enter minutes.
- ⊗ Confirm minutes entered.
Display: "Automatic summer time? __" blinks
If required, change the current setting (on/off) of the **Automatic summer time** function.
- ⏴ Activate function: Automatic summer time? On
- ⏴ Deactivate function: Automatic summer time? Off
- ⊗ Exit the menu item "Date / time".
Display: Settings level

Exiting the settings level

- ⏴ Select *Back*.
- ⊗ Exit the settings level.
Display: Normal display (depending on the application)

Note!

If no key is pressed for two minutes, the PLC automatically returns to the normal display.

2 Start-up

2.1 Programming

Programming the PLC requires a PC with ISaGRAF® software.

The ISaGRAF® software enables you to program a control system that is tailored to the specific needs of your plant (ISaGRAF® development environment 1400-7621). Programming must follow the structures and rules stipulated in IEC 61131-3. The PLC may be programmed with the languages defined in the standard: Sequential Function Chart (SFC), Instruction List (IL), Flow Chart (FC), Function Block Diagram (FBD), Ladder Diagram (LD), and Structured Text (ST).

There are 128 KB of memory available in the PLC for the ISaGRAF® application.

The application is compiled to machine code in the PC environment. This code is then transferred to the PLC over the front **RJ-45 jack** (connecting cable 1400-7620).

Programming languages:

Sequential Function Chart (SFC):	Used to describe operations of a sequential process with a simple graphic representation
Instruction List (IL):	Low-level textual language for logic and arithmetic operations
Flow Chart (FC):	High-level language used to visualize the data flow
Function Block Diagram (FBD):	Graphics-based language for building and combining complex functions (logical, arithmetic)
Ladder Diagram (LD):	Simple graphics-based language for logical operations (boolean)
Structured Text (ST):	High level language similar to PASCAL and C especially designed for control applications

For operation and application of the ISaGRAF® environment, refer to the documentation included in the software package. To enable simple and clear programming, ready-made functions and function blocks, e.g. for boiler systems, heat exchanger sequence control, ventilation systems, heating circuits or domestic hot water systems, are available from SAMSON.

Parameters*	WE	Settings level / Range of values
Station address	255	RS-232/Prog / 1 to 247, 255
Baud rate	9600	RS-232/Prog / 9600, 19200

* -> Section 5.3 (Description of communication parameters to be adjusted)

Note!

In ISaGRAF®, internal variables can be assigned (integer or bool) network addresses. The status or value of the internal variable is written to the associated holding or coil register and can be read or written over Modbus.

Important! The PLC application must be reloaded after a cold start.

2.2 Changing PLC settings

PLC settings can only be changed after entering the valid key code.

The valid key code can be found on page 42. To avoid unauthorized use, remove the page or make the key code unreadable.

Change PLC settings in the settings level, which contains the following menu items:

- ▶ Date / time, refer to section 1.4
- ▶ RS-232/Slave, refer to section 5.1
- ▶ RS-485/Master, refer to section 5.2
- ▶ RS-232/Prog, refer to section 2.1
- ▶ Meter bus, refer to section 5.4
- ▶ Universal input type, refer to section 2.3

Proceed as follows:

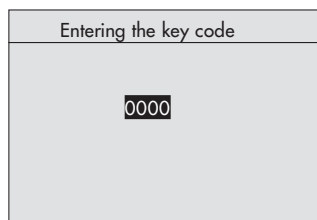

Activate the editing mode.
Display: Entering the key code
0000 blinks



Enter the valid key code.

Settings level
Date / time
RS-232/Slave
RS-485/Master
RS-232/Prog
Meter bus
Universal input type
Back

- ⊗ Confirm the key code.
Display: Settings level
The menu item "Date / time" is highlighted.
- ↓ Select the menu item in which the settings are to be changed, e.g. "RS-232/Slave".
- ⊗ Activate the selected menu item.
- ↓ Select the data point which you want to change.
- ⊗ Activate the editing mode of the data point.
Display: Data point blinks.
- ↓ Set the data point.
- ⊗ Confirm the setting.

RS-232/Slave
Modbus Slave
Modem
Baud rate
Back

Returning to the settings level

- ↓ Select *Back* to return to the settings level.
- ⊗ Exit the menu item.
Display: Settings level

Settings level
Date / time
RS-232/Slave
RS-485/Master
RS-232/Prog
Meter bus
Universal input type
Back

Exiting the settings level

- ↓ Select *Back* to return.
- ⊗ Exit the settings level.
Display: Normal display (depending on the application)

Note!

If no key is pressed for two minutes, the PLC automatically returns to the normal display.

2.3 Configuring universal inputs

There are 17 universal inputs, which may be used as binary inputs, analog inputs (0 to 10 V, 0/4 to 20 mA) or as sensor inputs. The hardware must be configured accordingly (sensor initialization).

Refer to page 38 for the resistance values of the PTC, Pt 100 and Pt 1000 sensors.

You can also configure each universal input separately.

The following configurations are available: Pt 100/500/1000/2000, Ni 200/1000/2000, PTC, NTC, 1–2 k Ω , BE, 0/4 to 20 mA (with 50 Ω parallel resistor) and 0 to 10 V.

Proceed as follows:

<p>Entering the key code</p> <p style="text-align: center;">0000</p>	<p>⇨ Activate the editing mode. Display: Entering the key code 0000 blinks</p>
<p>Settings level</p> <p>Date / time RS-232/Slave RS-485/Master RS-232/Prog Meter bus Universal input type</p> <p style="text-align: center;"><i>Back</i></p>	<p>⏴ Enter the valid key code.</p> <p>⊗ Confirm the key code. Display: <u>Settings level</u> The "Date / time" menu item is highlighted.</p>
<p>Universal input type</p> <p>UE01=PT100↔PT1000 UE02=PT100↔PT1000 UE03=PT100↔PT1000 UE04=PT100↔PT1000 UE05=PT100↔PT1000 UE06=PT100↔PT1000</p> <p style="text-align: center;"><i>Back</i></p>	<p>⏴ Select the menu item "Universal input type".</p> <p>⊗ Activate this selected menu item. The first universal input UE01 is highlighted.</p> <p>⏴ Select the universal input.</p> <p>⊗ Activate the universal input. Display: UE_ blinks.</p>

- ⏴ Select the type of universal input.
The inputs are available in the following order:
PT100↔PT1000, PT100↔PTC, NI2000, PT2000,
PT500, 0 – 10V, BE, 1000 – 2000Ω, PT100,
PT1000, NTC, PTC, NI1000, NI200, 4 – 20mA,
0 – 20mA

Note!

On selecting the universal input types PT100↔PT1000 or PT100↔PTC, this configuration applies then to all 17 universal inputs. Any inputs that have a different type need to be configured separately afterwards.

Binary inputs with terminal 10 functioning as GND are slow (delay of approx. 3 s).

Binary inputs with terminal 9 functioning as GND are fast (ms).

If a resistance input has been selected:

(PT100↔PT1000, PT100↔PTC, NI2000, PT2000, PT500, PT100, PT1000, NTC, PTC, NI1000 or NI200)

Universal input type
Calibrate? No
UE02=PT100↔PT1000
UE03=PT100↔PT1000
UE04=PT100↔PT1000
UE05=PT100↔PT1000
UE06=PT100↔PT1000
Back

- ⊗ Confirm the type of universal input.
Display: "Calibrate? No" blinks.

If the temperature sensor connected at the input is not to be calibrated:

- ⊗ Exit the universal input.

If the temperature sensor connected at the input is to be calibrated:

- ⏴ Set to "Calibrate? Yes".

- ⊗ Confirm calibration.
Display: **Temperature measured** by the sensor blinks.

Compare the temperature measured by the sensor with the temperature measured by a reference thermometer installed directly at the point of measurement.

If both temperatures are not the same:

- Correct the sensor temperature.
- Confirm corrected temperature.

Universal input type	
UE12=PT100↔PT1000	↑
UE13=PT100↔PT1000	
UE14=PT100↔PT1000	
UE15=PT100↔PT1000	
UE16=PT100↔PT1000	
UE17=PT100↔PT1000	
Back	

If another type of universal input is selected:

- Confirm the universal input type.

Returning to the settings level

- Select *Back* to return to the settings level.
- Exit the menu item.
Display: Settings level

Settings level	
Date / time	
RS-232/Slave	
RS-485/Master	
RS-232/Prog	
Meter bus	
Universal input type	
Back	

Exiting the settings level

- Select *Back* to return.
- Exit the settings level.
Display: Normal display (depending on the application)

2.4 Resetting to default values

The values in the settings level can be reset to their default values.

Important!

Resetting to default values causes a application saved in the PLC to be deleted.

Proceed as follows:

1. Cut the power supply to the PLC.
2. Restart the PLC, while pressing down the reset key ↵ with a pointed object.
"System is being initialized... Cold start values loaded!" appears briefly on the display before the normal display with the current firmware version (displays on page 5) appears.

The values of the setting level are the same as the default values (see section 8.1).

3 Manual operation

All outputs configured in manual operating mode. Refer to the wiring plan (-> section 7).

Note!

If the analog and binary output menus are activated without entering the key code beforehand, the key icon  appears at the top of the display when you press the enter key to confirm the setting. This setting is locked.

You can only change this setting after entering the key code first.

Proceed as follows:

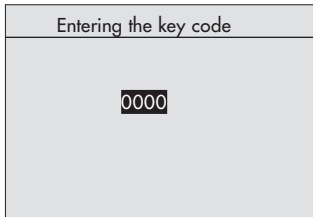

- ⇒ Activate the editing mode.
Display: Entering the key code
0000 blinks
- ⏴ Enter the valid key code.
- ⊗ Confirm the key code.
Display: Settings level
The "Date / time" menu item is highlighted.
- ⏴ Select *Back* to return.
- ⊗ Exit the editing mode.
Display: Normal display (depending on application)

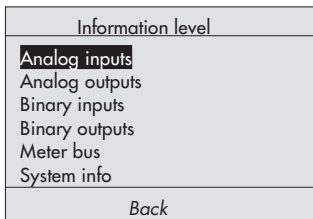

- ⏴ ⏵ Switch to the information level.
Display: Information level
"Analog inputs" menu item is highlighted.
- ⏴ Select required menu item "Analog outputs" or "Binary outputs".
- ⊗ Activate the menu item.
- ⏴ Select the required output.
- ⊗ Activate the selected output.
Display: **AA...** or **BA...** blinks.



Analog output setting: 0 to 10 V

- Increase the value.
- Reduce the value.

Setting with binary outputs: on/off

- Binary input = on
- Binary input = off

- Exit the output.
Display:  indicates manual intervention.

Information level	
Analog inputs	
Analog outputs	
Binary inputs	
Binary outputs	
Meter bus	
System info	
Back	

Exiting the information level

- Select *Back* to return.
- Exit the information level.
Display: Normal display (depending on application)

4 Operational faults

Displaying errors in the error status register and sending fault alarms to a mobile phone over the SMS function or to a fax machine can be configured in ISaGRAF® to match the application.

The corresponding function blocks exist for this purpose.

5 Communication

5.1 Modbus slave interface

The PLC can communicate with a control system using the RS-232 Modbus slave interface. Together with the suitable process visualization software and communication software, a complete control system can be implemented.

The following interface settings are possible:

– **Operation with a dial-up modem on the RS-232 Modbus slave interface**

Basically, communication is only established automatically when the application has been configured to dial when a fault occurs. The controller works autonomously. Nevertheless, the modem can dial up to the controller at any time to read data from it or change settings, if necessary. The use of the modem connecting cable (1400-7139) is recommended.

– **Operation with a leased line modem on the RS-232 Modbus slave interface**

Communication is established over a permanent connection between two leased line modems. This setup is applied for long-distance transmissions or when different signal level converters are used. The connection between the controller and the modem can also be established over the modem connecting cable (1400-7139).

– **Operation on a four-wire bus**

To link the controller and the bus line, the signal level needs to be converted by an appropriate converter (SAMSON cable converter 1400-7308).

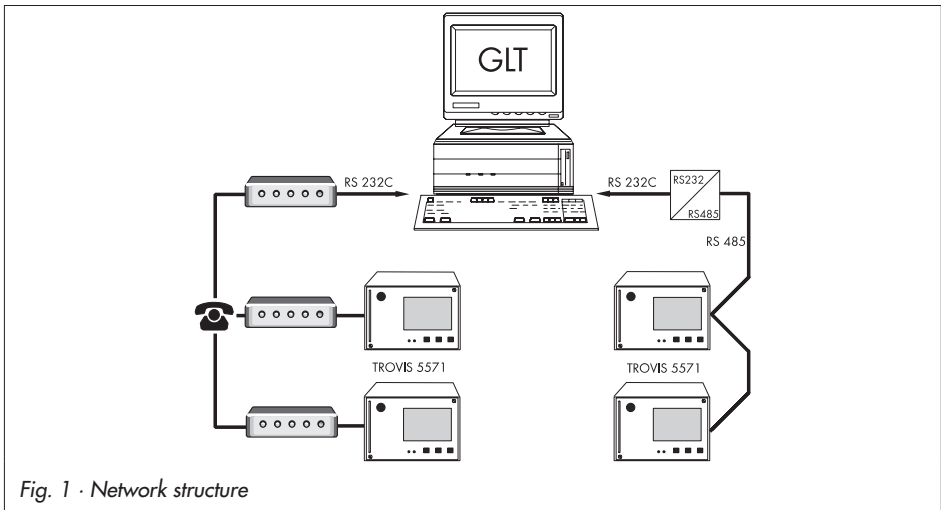

Fig. 1 · Network structure

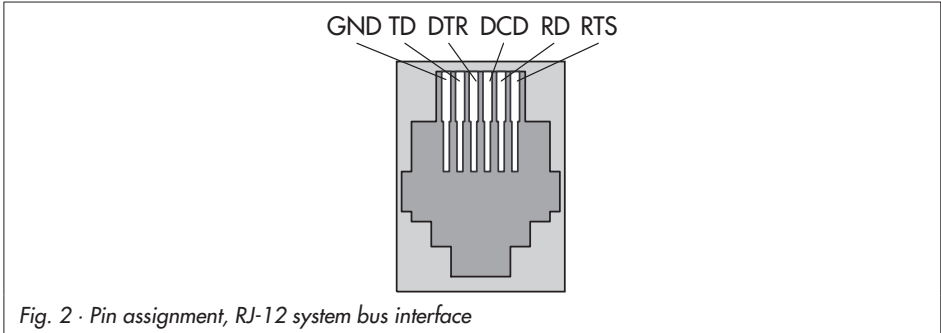

Fig. 2 · Pin assignment, RJ-12 system bus interface

Modbus slave interface RS-232

The Modbus connection is located on the rear panel of the controller housing (RJ 12 jack). The controller can be connected either directly to the serial interface of a PC (point-to-point connection) or to a (dial-up) modem. A dial-up modem is required if the controller is to be connected to the telecommunications network. In this case, the controller operates autonomously and issues an alarm to the building control station (GLT) when faults occur. In addition, the building control station can dial up to the controller and read data from it.

Parameters*	WE	Settings level / Range of values
Station address	255	RS-232/Slave > Modbus Slave / 1 to 247, 255
16-bit addressing?	No	RS-232/Slave > Modbus Slave > Station address / Yes, No
Control system monitoring	30 min	RS-232/Slave > Modbus Slave / 1 to 300 min
Modem	Off	RS-232/Slave Modem = On: PLC connected to telecommunications network Modem = Off: PLC directly connected to a computer
Cyclical initialization	30 min	RS-232/Slave > Modem = On / 1 to 300 min
Automatic disconnection	5 min	RS-232/Slave > Modem = On / 1 to 300 min
Baud rate	9600	RS-232/Slave / 9600, 19200

* -> Section 5.3 (Description of communication parameters to be adjusted)

Modbus slave interface in combination with RS-232/RS-485 cable converters (for four-wire bus)

Operating the PLC in combination with cable converters requires a permanent bus connection (data cable). The bus line links the devices/control units in an open ring. At the end of the bus line, the data cable is connected to the control station using an RS-485/RS-232 converter (e.g. TROVIS 5484). The maximum extension (cable length) of the bus line is 1,200 m. A maximum of 32 devices can be connected to such a segment. If you wish to use more than 32 devices or need to bridge greater distances, make sure repeaters (e.g. TROVIS 5482) are installed to replicate the signal. In all, a maximum of 246 devices can be connected to a bus line.

Caution!

Make sure that the relevant standards and regulations concerning lightning and overvoltage protection are observed upon installation.

Parameters*	WE	Settings level / Range of values
Station address	255	RS-232/Slave > Modbus Slave / 1 to 247, 255
16-bit addressing?	No	RS-232/Slave > Modbus Master > Station address / Yes, No
Control system monitoring	30 min	RS-232/Slave > Modbus Slave / 1 to 300 min
Modem	Off	RS-232/Slave / Modem = Off
Baud rate	9600	RS-232/Slave / 9600, 19200

* -> Section 5.3 (Description of communication parameters to be adjusted)

5.2 Modbus master interface

Modbus instruments can be connected to the PLC using the RS-485 Modbus master interface. The maximum bus line is 1,200 m. If you need to bridge greater distances, make sure repeaters (e.g. TROVIS 5482) are installed to replicate the signal.

Terminals 1 and 2 are used for connection (see Fig. 4). Up to four expansion modules can also be connected in parallel to these terminals. Refer to section 8.4.3 for more details.

Caution!

Make sure that the relevant standards and regulations concerning lightning and overvoltage protection are observed upon installation.

Parameters*	WE	Settings level / Range of values
Gateway	Off	RS-485/Master / On, Off
Addressing	8 bit	RS-485/Master / 8-bit, 16-bit
Baud rate	9600	RS-485/Master / 9600, 19200
Frame	Off	RS-485/Master / On, Off
Bias voltage	Off	RS-485/Master / On, Off
Validity	600 s	RS-485/Master / 0 to 600 s
Pause	0 ms	RS-485/Master / 0 to 100 ms
Timeout	100 ms	RS-485/Master / 100 to 10000 ms
Expansion module	Broadcast	RS-485/Master > Station address / 0 to 255, broadcast

* -> Section 5.3 (Description of communication parameters to be adjusted)

5.3 Description of communication parameters to be adjusted

Station address

This address is used to identify the PLC in bus or modem operation. In a system, each controller needs to be assigned a unique address.

Addressing/16-bit addressing

Selection between 16-bit addressing or 8-bit addressing

Select RS-232/Slave menu item (under *Station address*):

- ▶ 16-bit addressing? Yes – 16-bit addressing
- ▶ 16-bit addressing? No – 8-bit addressing

Baud rate

The baud rate setting refers to the transfer speed between the Modbus instruments.

Control system monitoring

Any intervention made by the control system on dynamic processes are restricted in time, provided that communication between the control system and the controller is not established. The controller resets the time monitoring after every valid retrieval of the station address. After the defined maximum time has elapsed, all even bits are reset to "autonomous".

Modem

- ▶ Modem = On:
PLC connected to telecommunications network over a modem (RS-232 Modbus slave interface)
- ▶ Modem = Off:
PLC directly connected to a computer (RS-232 Modbus slave interface) and on operating the PLC in combination with cable converters (RS-232/RS-485)

Cyclical initialization

This parameter defines the period of time for a cyclical issue of the initialization command "ATZ". The command is not issued during dial-up or when connected.

Automatic disconnection

When the controller connects to the building control station but without addressing a Modbus data point, the PLC closes the connection after the time specified for *Automatic disconnection* has elapsed.

Gateway

- ▶ Gateway = On:
Any polling by the building control station to the Modbus instruments connected to the PLC is passed directly on to the slaves.
- ▶ Gateway = Off:
Any polling by the building control station to the Modbus instruments connected to the PLC is not passed directly on to the slaves.

Frame

- ▶ Frame = On: Framing function activated
- ▶ Frame = Off: Framing function deactivated

Bias voltage

We recommend applying a bias voltage on the bus to keep the signal level stable. This bias voltage is usually applied to the bus by the Modbus master.

- ▶ Bias voltage = On: Bias voltage on the bus
- ▶ Bias voltage = Off: No bias voltage on the bus

Validity

The values saved in the PLC, which have been sent by the slaves, have a time-dependent *Validity*.

If the building control station polls the saved data within the valid period of time, the PLC sends the saved data directly to the building control station. However, if the polling to the PLC is outside of this valid time period, the PLC first polls the slaves and then sends these updated data to the building control station.

Pause

The time entered in *Pause* is the time that elapses before the PLC polls a slave after it has responded to the last polling by the PLC.

Timeout

If the slave does not respond to a PLC polling after the time in *Timeout* has elapsed, an alarm is generated.

Expansion module (1400-9386)

Expansion modules are connected by specifying their station address. This station address can be entered in default state (reset over the jumpers) using the last two figures of the serial numbers.

Example:

The serial number 600116 means that the station address is 16.

This can only be dialed by the broadcast function when **one** expansion module is connected.

5.4 Meter bus interface

Thanks to the meter bus interface, the PLC can communicate with up to 3 heat and water meters according to EN 1434-3.

Details on the use of the different heat and water meters can be found in the technical documentation TV-SK 6311.

5.4.1 Activating the meter bus

To successfully transfer data from the heat meter (WMZ) to the PLC, the heat meter must use a standardized protocol in accordance with EN 1434-3. It is impossible to make a general statement about which specific data can be accessed in each meter. For details on the different meter makes, refer to the technical documentation TV-SK 6311.

Meter bus
WMZ#1: EN1434/Cont. 250 WMZ#2: None WMZ#3: None
Back

All settings that are made for communication with heat or water meters are stored in Settings level > Meter bus > WMZ#_.

Set the parameters in the following sequence:

- Model code
- Reading mode
- Meter bus address

► **Model code** [None, P15, PS2, EN1434, CAL3, APAto, SLS]

The model code, which needs to be set for the respective heat meter, can be found in TV-SK 6311. In general, the default setting of 1434 can be used for most devices.

► **Reading mode** [Coil, Cont, 24h]

The meters can be read either automatically approx. every 24 hours (24h), continuously (con) or when the coils (= Modbus data points) assigned to the heat meters WMZ1 to WMZ3 are overwritten with the value 1 over the system bus interface (Coil).

Note!

With reading mode "24h", the displayed values are not updated by reading the status information again; the values read during the last cycle remain unchanged.

With reading mode "con", the values in the levels are not continuously updated. Reopen the specific level to get current values.

► **Meter bus address** (Addr?) [0 to 255]

A meter bus address must be unique and correspond with the address preset in the WMZ. If the preset meter bus address is unknown, a single heat meter connected to the controller can be assigned meter bus address 254. Address 255 deactivates communication with the respective heat meter.

Parameters	WE	Settings level / Range of values
Model code	None	Meter bus > WMZ#_ / None, P15, PS2, EN1434, CAL3, APAto, SLS
Reading mode		Meter bus > WMZ#_ / Coil, Cont, 24h
Meter bus address		Meter bus > WMZ#_ / 0 to 255

In the information level, "EN1434" is displayed when the meter bus is activated. Press the enter key to get to the display referring to the meter bus. The following information is displayed about the selected heat meter:

WMZ#1 (EN1434)	
ID no.:	FFFFFFF
Flow rate:	-.___ l/h
Total capacity:	-.___ m3
Capacity:	-.___ kW
Energy:	-.___ Mwh
Flow pipe:	- °C
Back	

- ▶ ID no.
- ▶ Flow rate [l/h]
- ▶ Total capacity [m³]
- ▶ Capacity [kW]
- ▶ Energy [Mwh]
- ▶ Flow pipe [°C]
- ▶ Return flow pipe [°C]
- ▶ Meter bus address
- ▶ Status

Note!

A blinking icon ! at the end of the header "WMZ#_ (EN1434)" indicates an operational fault.

Check the heat/water meter connection to the meter bus interface and check the parameters set in the Settings level > Meter bus > WMZ#_.

5.5 Data logging module

Data logging module inserted
L: Data logging A: wif_a02 (V90) A: kesf_a01 (V20) F: Firmware (V1.11) F: Firmware (V1.12)
Back

A data logging module (order no. 1400-9378) allows the firmware versions and applications to be saved and loaded in addition to data logging.

The data logging module is connected to the RJ-45 jack at the front of the controller. The menu shown here *) appears on the display as soon as the data logging module is inserted.

*) The menu items A: ... (application) and F: ... (firmware) depend on the current firmware and application of the PLC as well as on the firmware and application saved in the data logging module.

5.5.1 Data logging

The data logging module allows controller data to be saved. Without any additional programming, the controller saves the physical inputs 1 to 7 every minute. When the memory of the data logging module is full, the controller starts to write over the oldest data.

After connecting the data logging module, the "Data logging" menu item must be selected for this function.

Note!

The Data logging function causes all the data previously saved in the module to be deleted.



The data logging viewer software allows the data to be viewed in graph format. The USB-Converter 3 (order no. 1400-9377) is required to connect the data logging module to a computer. The data logging viewer software is supplied with the USB-Converter 3.

5.5.2 Saving and loading firmware and applications



On loading (represented by ) a firmware or application, data are downloaded from the data logging module onto the PLC.

Note!

An application or firmware can only be loaded after the key code has been entered.

- ▶  **A: ...** Downloading an application onto the PLC.
The application in the PLC is overwritten.
- ▶  **F: ...** Downloading a firmware onto the PLC.
The firmware in the PLC is overwritten.

On saving (represented by ) a firmware or application, data are uploaded from the PLC onto the data logging module.

- ▶  **A: ...** Uploading a current application onto the data logging module.
- ▶  **F: ...** Uploading the firmware onto the data logging module.

6 Installation

The controller consists of the housing with the electronics and the back panel with the terminals. It is suitable for panel, wall, and top hat rail mounting (Fig. 3).

Panel mounting

1. Remove both screws (1).
2. Pull apart the controller housing and back panel.
3. Make a cut-out of 138 x 92 mm (width x height) in the control panel.
4. Insert the controller housing through the panel cut-out.
5. Insert one mounting clamp (2) each at the top and bottom or at the sides. Screw the threaded rod towards the panel with a screwdriver such that the housing is clamped against the control panel.
6. Install the electrical connections at the back of the housing as described in section 7.
7. Fit the controller housing.
8. Fasten both screws (1).

Wall mounting

1. Remove both screws (1).
2. Pull apart the controller housing and back panel.
3. If necessary, bore holes with the specified dimensions in the appropriate places. Fasten the back panel with four screws.
4. Install the electrical connections at the back of the housing as described in section 7.
5. Fit the controller housing.
6. Fasten both screws (1).

Top hat rail mounting

1. Remove both screws (1).
2. Pull apart the controller housing and the back panel.
3. Fasten the spring-loaded hook (4) at the bottom of the top hat rail (3).
4. Slightly push the controller upwards and pull the upper hook (5) over the top hat rail.
5. Install the electrical connections at the base as described in section 7.
6. Remount the controller housing.
7. Fasten both screws (1).

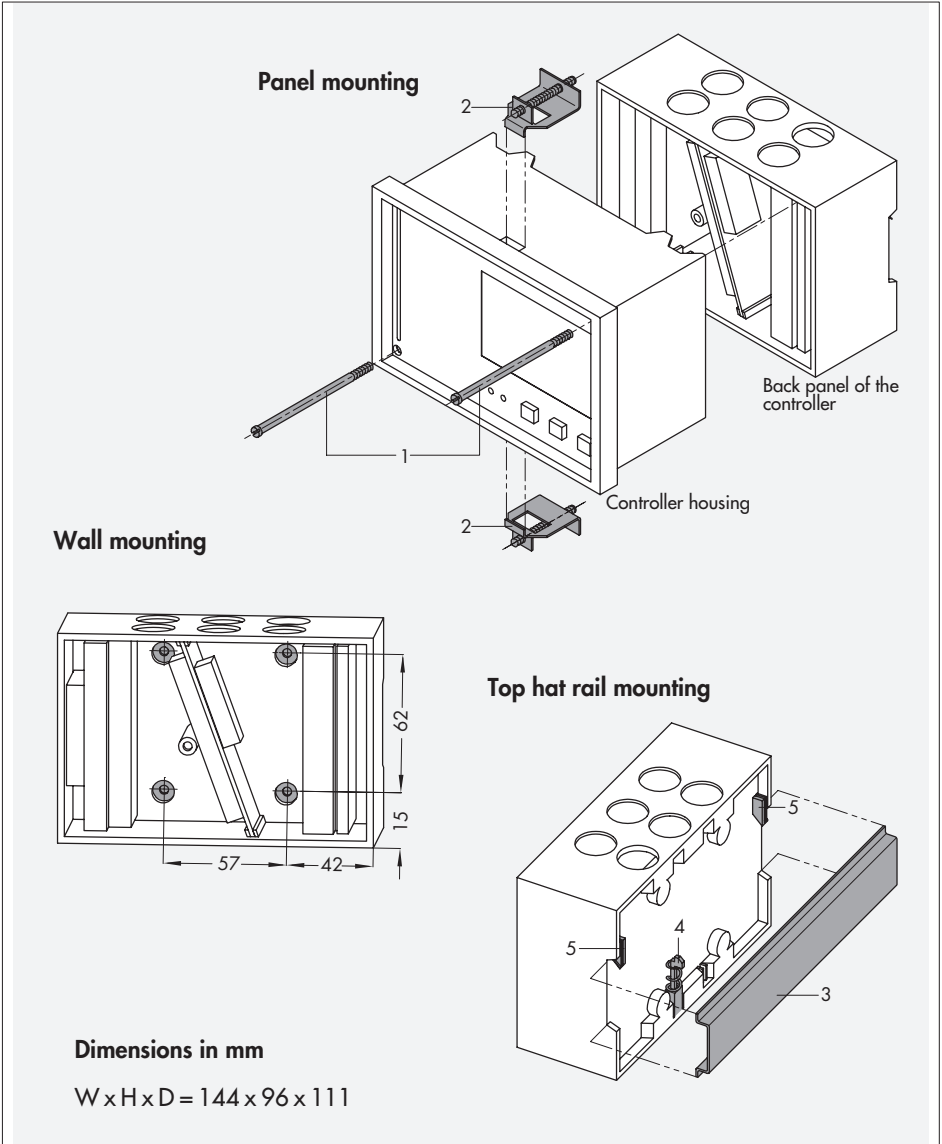

Fig. 3 · Installation

7 Electrical connection

Caution!

For electrical connection of the PLC, you are required to observe the relevant electrotechnical regulations of the country of use as well as the regulations of the local power supplier. Make sure all electrical connections are installed by trained and qualified personnel!

Notes on installing the electrical connections

- ▶ Install the 230 V power supply lines and the signal lines separately! To increase noise immunity, observe a minimum distance of 10 cm between the lines. Make sure the minimum distance is also observed when the lines are installed in a cabinet.
- ▶ The lines for digital signals (bus lines) and analog signals (sensor lines, analog outputs) must also be installed separately.
- ▶ In plants with a high electromagnetic noise level, we recommend to use shielded cables for the analog signal lines. Ground the shield at one side, either at the control cabinet inlet or outlet, using the largest possible cross-section. Connect the central grounding point and the PE grounding conductor with a cable $\geq 10 \text{ mm}^2$ using the shortest route.
- ▶ Inductances in the control cabinet, e.g. contactor coils, are to be equipped with suitable interference suppressors (RC elements).
- ▶ Control cabinet elements with high field strength, e.g. transformers or frequency converters, should be shielded with separators providing a good ground connection.

Overvoltage protection

- ▶ If signal lines are installed outside buildings or over large distances, make sure appropriate surge or overvoltage protection measures are taken. Such measures are indispensable for bus lines!
- ▶ The shield of signal lines installed outside buildings must have current conducting capacity and be grounded on both sides.
- ▶ Surge diverters must be installed at the control cabinet inlet.

Noise suppression

The TROVIS 5571 Controller with SAMSON actuator is interference suppressed according to VDE 0875. If different actuator makes are used, or moreover, further actuators with interference sources are used in a plant, the operator/supplier of a custom-made plant must make sure that the entire plant complies with VDE 0875 regulations due to the legal obligation of ensuring interference suppression.

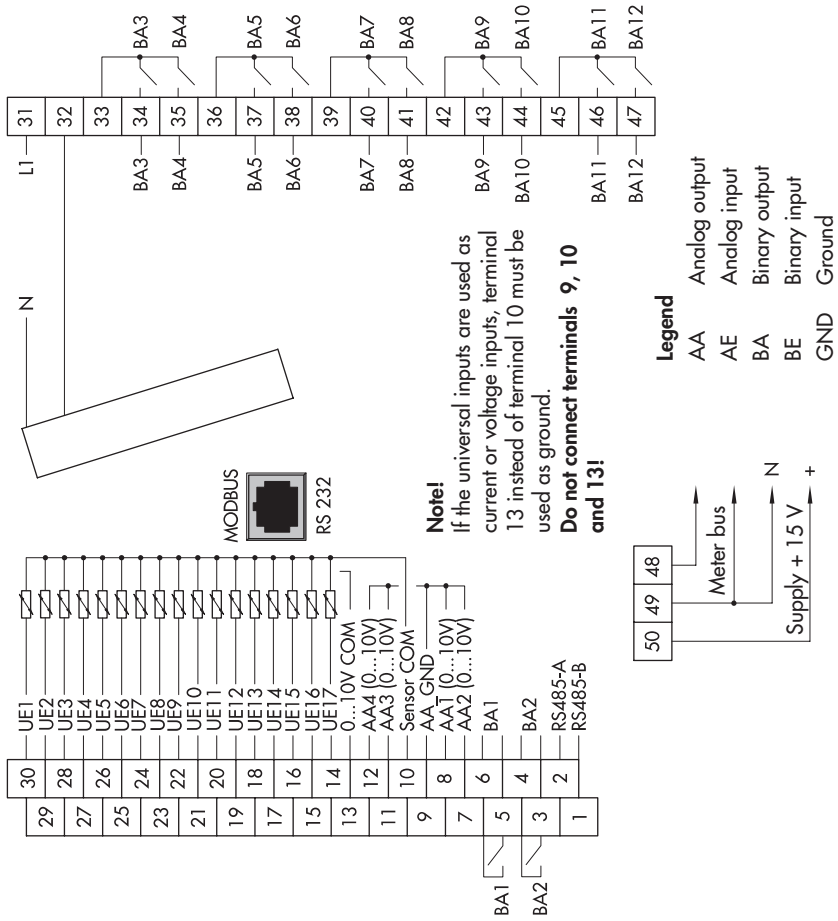

Fig. 4 · Wiring plan of TROVIS 5571

Connecting the PLC

Open the housing to connect the cables. Make holes in the marked locations at the top, bottom or back of the housing's back panel and fit suitable grommets or screw joints.

Observe the diagram (Fig. 4) for connection. The connection diagram contains all possible inputs and outputs. The assignment of the corresponding inputs and outputs is determined by the respective application.

Inputs

When wiring the universal inputs (BE1/AE1 to BE17/AE17), make sure to use terminal 13 as ground in case of active inputs (current and voltage inputs). If the universal inputs are used as passive inputs (sensors or binary inputs), terminal 10 must be used as ground.

Binary inputs with terminal 10 functioning as ground (GND) are slow (a delay of approx. 3 seconds).

Binary inputs with terminal 9 functioning as ground (GND) are fast (ms).

Outputs

The binary low-voltage outputs (BA1 and BA2) are used for signaling. As a result, only a minimal load can be applied to these outputs (50 V DC, max. 100 mA ohmic load). If greater loads are to be applied, it is recommended to control relays over the outputs which then switch the elevated load.

The 10 binary outputs (BA3 to BA12) can be loaded with max. 250 V AC, 2 A.

Modbus

The control station is connected over a serial RS-232 interface at the back of the controller.

Further Modbus instruments (slaves) are connected to the PLC over the RS-485 interface (terminals 1 and 2).

Connecting the sensors

Cables with a minimum cross-section of $2 \times 0.5 \text{ mm}^2$ can be connected to the terminals at the back panel of the housing.

8 Appendix

8.1 Settings level

Menu item	Functions/parameters	Setting range	WE	See section
Date/time	System time (date and time) freely configurable			
	Automatic summer time	On / Off	On	
RS-232/Slave *) Only with modem = On	Modbus slave			5.1
	Station address	1 to 247, 255	255	
	16-bit addressing	Yes / No	No	
	Control system monitoring	1 to 300 min	30 min	
	Modem Cyclical initialization *)	On / Off	Off	
	Auto. disconnection *)	1 to 300 min	30 min	
	Baud rate	9600, 19200	9600	
RS-485/Master	Gateway	On / Off	Off	5.2
	Addressing	8 bit, 16 bit	8 bit	
	Baud rate	9600, 19200	9600	
	Frame	On / Off	Off	
	Bias voltage	On / Off	Off	
	Validity	0 to 600 s	0 s	
	Pause	0 to 100 ms	0 ms	
	Timeout	100 to 10000 ms	100 ms	
	Expansion module Station address	0 to 255	0	
RS-232/Prog	Station address	1 to 247, 255	255	2.1
	Baud rate	9600, 19200	9600	

Menu item	Functions/parameters	Setting range	WE	See section
Meter bus	WMZ#1 to WMZ#3 Model code Reading mode Meter bus address	None, P15, PS2, EN1434, CAL3, APAto, SLS Coil, Cont, 24h 0 to 255	None	5.4
Universal input type	UE01 to UE17	PT100↔PT1000 ^{1) 2)} , PT100↔PTC ^{1) 2)} , NI2000 ²⁾ , PT2000 ²⁾ , PT500 ²⁾ , 0–10V, BE, 1000–2000Ω, PT100 ²⁾ , NTC ²⁾ , PTC ²⁾ , NI1000 ²⁾ , NI200 ²⁾ , 4–20mA, 0–20mA ¹⁾ Settling valid for all UE ²⁾ Calibration? Yes / No	PT100↔ PT1000	2.3

8.2 Technical data

TROVIS 5571 Programmable Logic Controller (PLC)	
Universal inputs	17 universal inputs, separately configurable as: <ul style="list-style-type: none"> – Resistance input Pt 100/500/1000, Ni 200/1000/2000, PTC/NTC, 1–2 kΩ – Current input 0/4 to 20 mA (50 Ω parallel resistor) – Voltage input 0–10 V – Binary input, floating
Outputs	10 binary relay outputs, non-floating in pairs, 2 A/250 V AC 2 low-voltage binary outputs, 100 mA/50 V AC 4 analog outputs (0 to 10 V), non-floating in pairs (max. load > 4.7 k Ω)
Interfaces	
Modbus slave interface	RS-232 for modem or point-to-point communication with PC (RJ-12 jack at the back)
Optional:	Modbus interface RS-485 over cable converter 1400-7308
Modbus master interface	RS-485 for communication with other Modbus instruments (connected over terminals 1/2)
Meter bus	Connected over terminals 48/49/50
Programming interface	For installing an application created in IsaGraf [®] (front RJ-45 jack) and data logging
Voltage supply	230 V AC, 48 to 62 Hz
Power consumption	Approx. 8 VA
Ambient temperature	0 to 40 °C
Storage temperature	–20 to 60 °C
Degree of protection	IP 40
Class of protection	II
Degree of contamination	2
Overvoltage category	II
Humidity rating	F
Noise emission	According to EN 61000-6-3
Noise immunity	According to EN 61000-6-1
Noise suppression	According to DIN VDE 0875
Weight	Approx. 0.6 kg

8.3 Special key codes

Description	Key codes
Task info	21
Delete PLC application	17
Interface protocols	20
Restart controller	15

8.4 Expansion modules

8.4.1 Technical data

Extension of the inputs and outputs at the programmable logic controller (PLC)	
Inputs	
Binary inputs	6 · Optionally can be used as: – 0 to 10 V input (inputs 1, 2, 5, 6) – Pt 1000 input (inputs 3, 4) – 0 to 1000 Ω input (inputs 3, 4) – Counter inputs, max. 1 kHz (inputs 1, 2) – 0 to 10 V outputs (inputs 5, 6)
Outputs	
Binary outputs	4 · 230 V/2 A (relay)
Interfaces	Modbus RS-485
Operating voltage	24 V AC ¹⁾
Dimensions [mm]	
Width	140
Height	93
Depth	30

¹⁾ **Note!**

The expansion module 1400-9386 (power supply 24 V AC) can be used in conjunction with TROVIS 5571 PLC (power supply 230 V AC) or with TROVIS 5572 Room Controllers (power supply 24 V AC).

A 230 V AC/24 V AC transformer is required for the expansion module when it is used in conjunction with the TROVIS 5571 Programmable Logic Controller!

8.4.2 Terminal assignment

1	BA1	Binary output 1	230 V/2 A
2	BA2	Binary output2	230 V/2 A
3	COM1/2	COM binary output 1/2	
4	BA3	Binary output 3	230 V/2 A
5	BA4	Binary output 4	230 V/2 A
6	COM3/4	COM binary output 3/4	
7	AC1 24V	Power supply 24 V AC	AC 1
8	AC2 24V		AC 2 has GND reference
9	BE1	Binary input 1 or 0 to 10 V input	Or counter input
10	BE2	Binary input 2 or 0 to 10 V input	Or counter input
11	(GND input 1/2	
12	BE3	Binary input 3 or Pt 1000 or 0 to 1000 Ω	
13	BE4	Binary input 4 or Pt 1000 or 0 to 1000 Ω	
14	(GND input 3/4	
15	BE5	Binary input 5 or 0 to 10 V input	Or 0 to 10 V output
16	BE6	Binary input 6 or 0 to 10 V input	Or 0 to 10 V output
17	(GND input/output 5/6	
18	A1	RS-485/MODBUS (slave)	Connection to TROVIS 5571/5572
19	B1		
20	A2	RS-485/MODBUS (master)	Connection to expansion module(s) ¹⁾
21	B2		

¹⁾ Only with smart expansion module, functioning similar to a basis device

8.4.3 Integrating the expansion modules

A maximum of four expansion modules (1400-9386) can be integrated over the Modbus master interface (Fig. 5)

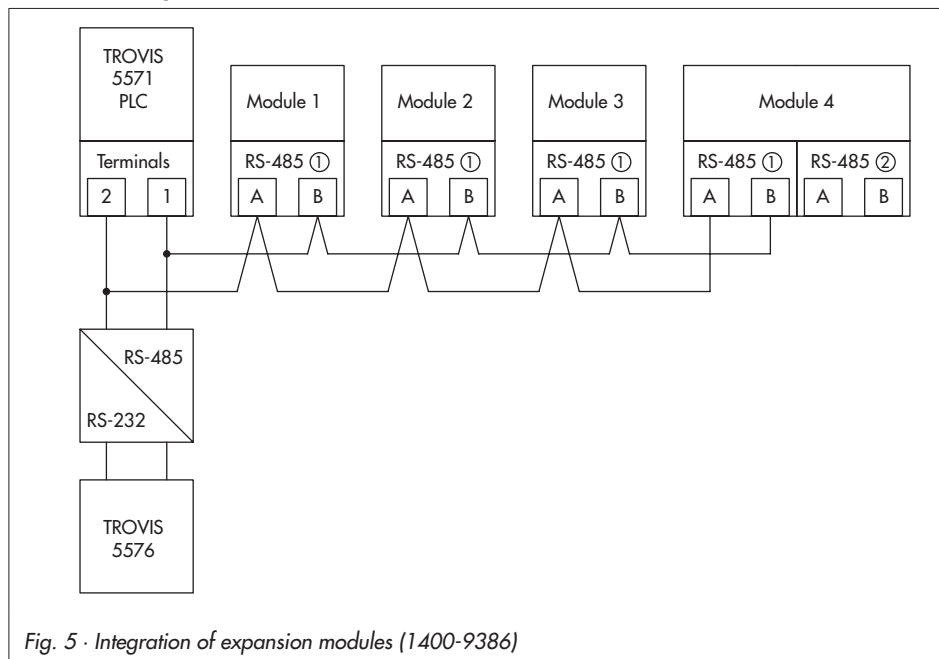

Fig. 5 · Integration of expansion modules (1400-9386)

The expansion modules are integrated in the Settings level under the menu item RS-485/Master -> Expansion module.

The following menu appears when an expansion module has been found:

Expansion module
Serial no.: 116
Station address: ---
E1 = BE
E2 = BE
E3 = BE
E4 = BE
Back

The station address can be assigned (to match the ISaGRAF® project) in this menu and the inputs or outputs (0 to 10 V) E1 to E6 of the expansion modules can be configured.

8.5 Sensor resistance tables

Resistance values with PTC resistors

Type 5224 Outdoor Temperature Sensors, Types 5264 and 5265 Flow and Return Flow Temperature Sensors, Type 5264 Storage Tank Temperature Sensors

°C	-20	-10	0	10	20	25	30	40	50	60	70	80	90	100	110	120
Ω	694	757	825	896	971	1010	1050	1132	1219	1309	1402	1500	1601	1706	1815	1925

Resistance values with Pt 1000 resistors

Type 5227-2 Outdoor Temperature Sensors, Type 5277-2 (thermowell required) and Type 5267-2 (contact sensor) Flow, Return Flow and Storage Tank Temperature Sensors. Type 5257-1, Type 5257-5 (room panel) Room Temperature Sensors.

°C	-35	-30	-25	-20	-15	-10	-5	0	5	10
Ω	862.5	882.2	901.9	921.6	941.2	960.9	980.4	1000.0	1019.5	1039.0

°C	15	20	25	30	35	40	45	50	55	60
Ω	1058.5	1077.9	1097.3	1116.7	1136.1	1155.4	1174.7	1194.0	1213.2	1232.4

°C	65	70	75	80	85	90	95	100	105	110
Ω	1251.6	1270.7	1289.8	1308.9	1328.0	1347.0	1366.0	1385.0	1403.9	1422.9

°C	115	120	125	130	135	140	145	150
Ω	1441.7	1460.6	1479.4	1498.2	1517.0	1535.8	1554.5	1573.1

Resistance values with Pt 100 resistors

Refer to the table for Pt 1000 resistors and divide the specified values by 10.

Type 5225 Outdoor Temperature Sensors, Types 5204, 5205-46 to -48 Flow and Return Flow Temperature Sensors, Types 5205-46 to -48 Storage Tank Temperature Sensors, Type 5255 Room Temperature Sensors.

8.6 Customer data

Station	
Operator	
Relevant SAMSON office	

Settings

Functions/parameters	Setting range	Setting
Date/time		
System time (date and time) freely configurable		
Automatic summer time	On/Off	
RS-232/slave		
Station address	1 to 247, 255	
16-bit addressing	Yes/No	
Control system monitoring	1 to 300 min	
Modem	On/Off	
Cyclical initialization	1 to 300 min	
Auto. disconnection	1 to 300 min	
Baud rate	9600, 19200	
RS-485/master		
Gateway	On/Off	
Addressing	8 bit, 16 bit	
Baud rate	9600, 19200	
Frame	On/Off	
Bias voltage	On/Off	
Validity	0 to 600 s	
Pause	0 to 100 ms	
Timeout	100 to 10000 ms	
Expansion module Station address	0 to 255, broadcast	

Appendix

Meter bus		WMZ#1	WMZ#2	WMZ#3
Model code	None, P15, PS2, EN1434, CAL3, APAt0, SLS			
Reading mode	Coil, cont, 24h			
Meter bus address	0 to 255			

Universal input UE	1	2	3	4	5	6	7	8	9	10	11	12	13	14	15	16	17
PT100↔PT1000																	
PT100↔PTC																	
NI2000																	
PT2000																	
PT500																	
0-10V																	
BE																	
1000-2000Ω																	
PT100																	
NTC																	
PTC																	
NI1000																	
NI200																	
4-20mA																	
0-20mA																	

Index

16-bit addressing	22	F	
8-bit addressing	22	Firmware version	5
A		saving/loading	27
Addressing	22	Flow Chart	10
Application		Frame	23
saving/loading	27	Function Block Diagram	10
Automatic disconnection	23	G	
B		Gateway	23
Baud rate	22	I	
Bias voltage	23	Information level	7
C		Installation	
Changeover key	4	Panel mounting	28
Communication parameters	22	Top hat rail mounting	28
Configuring inputs	13	Wall mounting	28
Connection		Instruction List	10
PLC	32	Interface	
Sensors	32	RS-232 (Modbus slave)	19 - 20
Slaves	32	RS-232/RS-485 (Modbus slave)	21
Contrast (display)	6	RS-485 (Modbus master)	21
Control system monitoring	22	Internal variable	11
Controller time	8	ISaGRAF	10
Cursor key(s)	4	L	
Customer data	40	Ladder Diagram	10
Cyclical initialization	23	M	
D		Manual operation	16 - 17
Data logging module	26	Meter bus	24
data logging	26	Modbus master interface	21
saving/loading applications	27	Modbus slave interface	19
saving/loading firmware versions	27	Modem	
Display	5	Dial-up modem	19
E		Leased line	19
Enter key	4	Modem on/off	23
Expansion module	24	N	
integrating	21, 38	Noise suppression	30
technical data	36		
terminal assignment	37		

O		S	
Operating elements	4	Sensor resistance values	39
Operational faults	18	Sequential Function Chart	10
Overvoltage protection	30	Station address	22
P		Structured Text	10
Pause	24	T	
Plain text display	5	Technical data	35
Programming	10	Timeout	24
R		V	
Reset key	4	Validity	24
Resistance input		W	
Calibration	14	Wiring plan	31

Key code

1732

