

**Automation System TROVIS 5500
Heating and District Heating Controller
TROVIS 5575**



**Mounting and
Operating Instructions**

EB 5575 EN

Firmware version 1.4x

Edition September 2005



Disclaimer of liability

We are constantly developing our products and therefore, reserve the right to change the product or the information contained in this document at any time without notice.

We do not assume any liability for the accuracy or completeness of these mounting and operating instructions. Moreover, we do not guarantee that the buyer can use the product for an intended purpose. SAMSON rejects any liability for claims by the buyer, especially claims for compensation including lost profits or any other financial loss, except the damage was caused intentionally or by gross negligence. If an essential term of the contract is breached by negligence, SAMSON's liability is limited to the foreseeable damage.

Safety instructions



- ▶ The device may only be assembled, started up or operated by trained and experienced personnel familiar with the product. Proper shipping and appropriate storage are assumed.
- ▶ The controller has been designed for use in electrical power systems. For wiring and maintenance, you are required to observe the relevant safety regulations.

Table of contents

1	Operation	6
1.1	Operating elements	6
1.1.1	Rotary pushbutton and changeover key	6
1.1.2	Rotary switches	7
1.2	Operating modes	8
1.3	Display	9
1.4	Displaying data	10
1.5	Setting the controller time	11
1.6	Setting the times-of-use	12
1.7	Setting party mode	14
1.8	Activating extended operating level	15
1.8.1	Setting public holidays	16
1.8.2	Setting vacation periods	17
1.9	Presetting room and DHW temperature set points	19
2	Start-up	21
2.1	Setting the system code number	21
2.2	Activating and deactivating functions	22
2.3	Changing parameters	24
2.4	Calibrating the sensors	25
2.5	Resetting to default values	26
3	Manual operation	27
4	Systems	28
5	Functions of the heating circuit	44
5.1	Weather-compensated control	44
5.1.1	Gradient characteristic	45
5.1.2	4-point characteristic	46
5.2	Fixed set point control	47
5.3	Underfloor heating/drying of jointless floors	48
5.4	Deactivation depending on outdoor temperature	49
5.4.1	OT deactivation value in rated operation	49
5.4.2	OT deactivation value in reduced operation	49
5.4.3	OT activation value in rated operation	50
5.4.4	Summer mode	50
5.5	Delayed outdoor temperature adaptation	51
5.6	Remote operation	51
5.7	Optimization	52

5.8	Flash adaptation	53
5.8.1	Flash adaptation without outdoor sensor (room temperature dependent)	54
5.9	Adaptation	55
6	Functions of the DHW circuit.	56
6.1	DHW heating in the storage tank system	56
6.1.1	DHW circuit additionally controlled by a globe valve	58
6.2	DHW heating in the storage tank charging system	59
6.3	DHW heating with solar system	61
6.4	Intermediate heating operation	62
6.5	Parallel pump operation	62
6.6	Circulation pump operation during storage tank charging.	62
6.7	Priority operation	63
6.7.1	Reverse control	63
6.7.2	Set-back operation	63
6.8	Forced charging of the DHW storage tank	64
6.9	Thermal disinfection of the DHW storage tank	64
7	System-wide functions	66
7.1	Automatic summer time/winter time changeover	66
7.2	Frost protection	66
7.3	Forced operation of the pumps.	67
7.4	Return flow temperature limitation	67
7.5	Condensate accumulation control	68
7.6	Three-step control	69
7.7	On/off control	69
7.8	Releasing a control loop over the binary input	69
7.9	Processing of external demand in Rk1	70
7.10	Flow rate/heat capacity limitation in Rk1	72
7.10.1	Limitation using pulse input	72
7.10.2	Limitation using 0/4 to 20 mA signal	73
7.10.3	Creep feed rate limitation over binary input	74
7.11	Device bus	74
7.11.1	Requesting and processing an external demand	75
7.11.2	Sending and receiving outdoor temperatures	76
7.11.3	Synchronizing the clock	77
7.11.4	Priority over all controllers	77
7.11.5	Connecting a TROVIS 5570 Room Panel	78
7.11.6	Display error alarms issued by the device bus	78
7.12	Feeder pump operation	79
7.13	Locking manual level	79

7.14	Locking the rotary switches	79
7.15	Setting a customized key number	80
8	Operational faults	81
8.1	Error list	81
8.2	Sensor failure	81
8.3	Temperature monitoring	82
9	Memory module	83
10	Installation	84
11	Electrical connection.	86
12	Appendix.	89
12.1	Function block lists	89
12.2	Parameter lists	100
12.3	Assignment of the rotary switches.	107
12.4	Sensor resistance tables	108
12.5	Technical data	109
12.6	Customer data	110
	Index	116
	Frequently used abbreviations	119

1 Operation

The controller is ready for use with the temperatures and operating schedules preset by the manufacturer.

On start-up, the **current time and date** need to be set at the controller (-> section 1.5).

1.1 Operating elements

The operating controls are located in the front panel of the controller and protected by a Plexiglas door.

1.1.1 Rotary pushbutton and changeover key

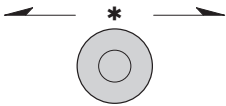

Rotary pushbutton

Turn (↻):
Display, select parameters and function blocks

Press *:
Confirm adjusted selection or settings



Changeover key

(use pen or any other pointed item to press)

Press to switch between operating level and configuration/parameter level

1.1.2 Rotary switches

Use the three rotary switches to adjust the desired operating mode (icons on the left) and the relevant parameters (icons on the right).

The top and middle switches are assigned to the heating circuits (see page 107). The rotary switch in the middle is not used in systems without a second heating circuit.

The bottom switch is assigned to the DHW circuit.

Rotary switch to adjust the operating modes of the heating circuit

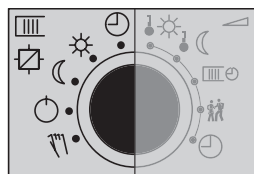

- ☉ Automatic/time-controlled operation with switchover between day and night modes
- ☀ Day mode (rated operation)
- ☾ Night mode (reduced operation)
- ⊖ Control operation deactivated, frost protection only
- ✋ Manual operation: correction value adjusted in percent and activation/deactivation of the pumps

Rotary switch to adjust the parameters of the heating circuit

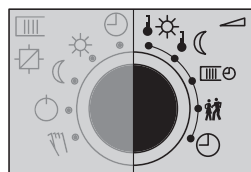

- ☀ Day set point (rated room temperature)
- ☾ Night set point (reduced room temperature)
- ☉ Times-of-use for heating
- 👤 Party mode
- ⌚ Controller time: setting current time, date and year



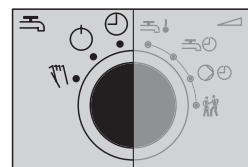



Rotary switch to adjust the operating modes of the DHW circuit

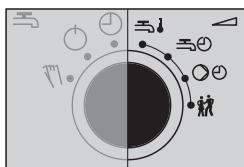

- ☉ Automatic/time-controlled operation with switchover between times when DHW heating is permissible/impermissible
- ⊖ DHW heating deactivated, frost protection only
- ✋ Manual operation: correction value adjusted in percent and activation/deactivation of the pumps

Rotary switch to adjust the parameters of the DHW circuit



-   Set point for DHW temperature
-   Times-of-use for DHW heating
-   Times-of-use for DHW circulation pump
-  Party mode

Note!

If several rotary switches are set to "Parameter" (right side),  blinks on the display. The controller cannot be operated.

1.2 Operating modes

Day mode (rated operation)

Regardless of the programmed times-of-use and summer mode, the set points relevant for rated operation are used by the controller.

Night mode (reduced operation)

Regardless of the programmed times-of-use, the set points relevant for reduced operation are used by the controller.

Automatic/time-controlled operation

During the programmed times-of-use, the controller works in rated operation. Outside these times-of-use, the controller is in reduced operation, unless control operation is deactivated depending on the outdoor temperature. The controller switches automatically between both operating modes.

Manual operation

Valves and pumps can be controlled manually (-> section 3).

1.3 Display

During operation, the display indicates the current time as well as information about the operation of the controller. The times-of-use are represented by black squares below the row of numbers at the top of the display. Icons indicate the operating status of the controller.

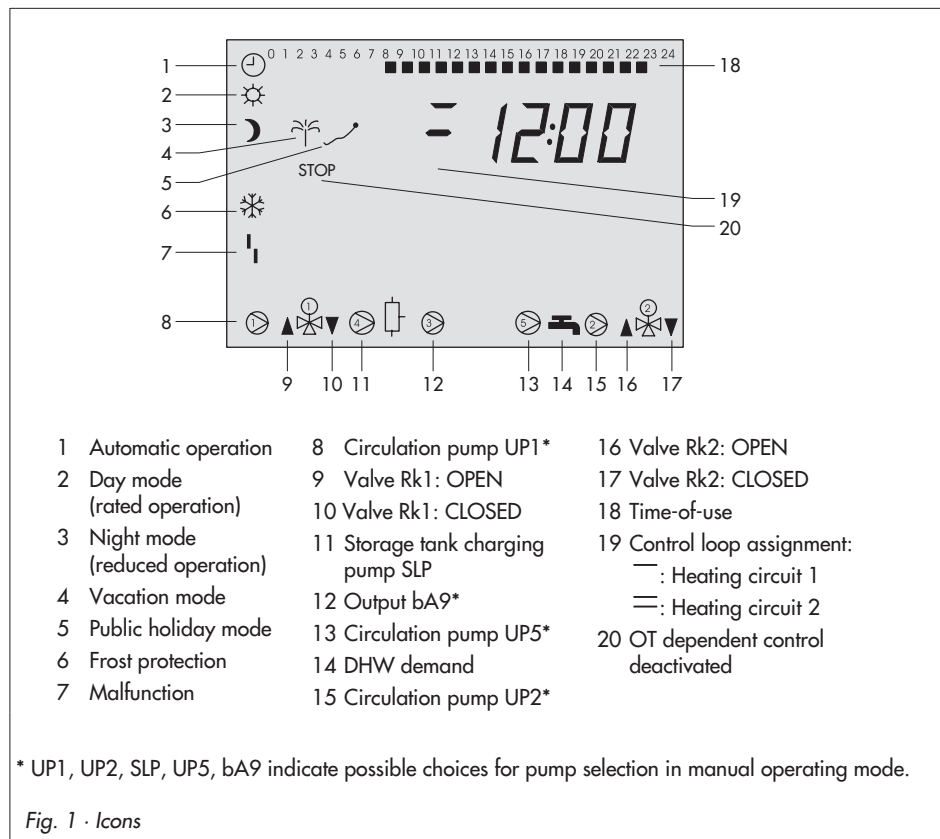

Fig. 1 · Icons

The controller status can be displayed in operating level (→ section 1.4).

1.4 Displaying data

The time, date, public holidays and vacation periods as well as the temperatures of connected sensors and their set points can be retrieved and displayed with the help of the rotary pushbutton.

Note!













Data can also be viewed in manual operating mode VF .

*To do so, select **Info**, confirm and proceed as described below.*

Proceed as follows:

① Select value.

Depending on the configuration of the controller, the different data points are displayed:

-  Time
-  Room temperature, heating circuit 1, 2
-  Outdoor temperature
-  Temperature at flow sensor VF, heating circuit 1, 2
-  Temperature at flow sensor VF1, primary heat exchanger circuit
-  Temperature at flow sensor VF2, DHW circuit
-  Temperature at solar collector sensor VF3
-  Temperature at return flow sensor RüF
-  Temperature at storage tank sensor SF1
-  Temperature at storage tank sensor SF2
-  Temperature at storage tank sensor SF2 of the solar circuit
-  Temperature at flow sensor VF4

* Compare the set point/limit value and the actual value.
Press the rotary pushbutton to display the time and date.

1.5 Setting the controller time

The current time and date need to be set immediately after start-up and after a power failure of more than 24 hours has occurred. This is the case when the time blinks on the display.

Proceed as follows:

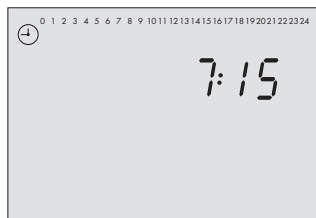

Turn the top rotary switch to position  "Controller time" (right side).

Display shows: time

 Edit the controller time.



* Confirm the adjusted time.

Display shows: year

 Edit the year.



* Confirm the adjusted year.

Display shows: date (day.month)

 Edit the date.

* Confirm the adjusted date.

Display shows: time

Return the rotary switch to the desired operating mode (left side).





1.6 Setting the times-of-use

Three times-of-use can be set for each day of the week.

If only one time-of-use is required, the start and stop times of the second time-of-use must be adjusted to identical values. In this case, the third time-of-use is not displayed.

If only two times-of-use are required, the start and stop times of the third time-of-use must be adjusted to identical values.

The times-of-use for the different control circuits are adjusted at the rotary switches **one after the other**:

Times-of-use	Rotary switch	Position
Heating circuit 1/primary heat exchanger circuit	Top	
Heating circuit 2/supplementary heating circuit	Middle	
DHW heating	Bottom	
Circulation pump	Bottom	

Parameters	WE*	Range of values
Time period/day	1-7	1-7, 1, 2, 3, 4, 5, 6, 7 with 1-7 = daily, 1 = Monday, 2 = Tuesday, ..., 7 = Sunday
Start first time-of-use	06:00	00:00 to 24:00 h; in steps of 15 minutes
Stop first time-of-use	22:00	00:00 to 24:00 h; in steps of 15 minutes
Start second time-of-use	22:15	00:00 to 24:00 h; in steps of 15 minutes
Stop second time-of-use	22:15	00:00 to 24:00 h; in steps of 15 minutes
Start third time-of-use	-	00:00 to 24:00 h; in steps of 15 minutes
Stop third time-of-use	-	00:00 to 24:00 h; in steps of 15 minutes

* Default values (WE) valid for heating circuit 1/primary heat exchanger circuit (top rotary switch)

Proceed as follows:

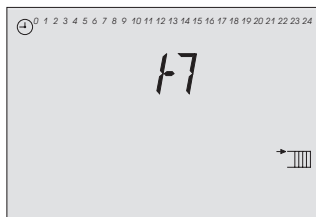

Turn appropriate rotary switch to position "Times-of-use".

Display shows: **1-7**

- (C) Select period/day for which the times-of-use are to be valid:
1-7 = every day,
1 = Monday, 2 = Tuesday, ..., 7 = Sunday

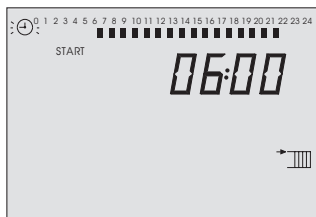

- * Activate editing mode for period/day.
Display shows: **START**, ⊕ blinks

- (C) Edit start time (steps of 15 minutes).

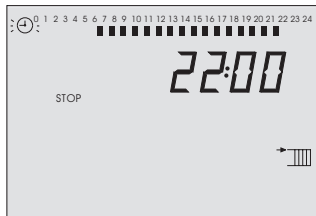

- * Confirm start time.
Display shows: **STOP**

- (C) Edit stop time (steps of 15 minutes).

- * Confirm stop time.
Display shows: **START**
The second time-of-use is set like the first time-of-use.

To set the times-of-use for each day, repeat the instructions in the fields highlighted in gray. Return the rotary switch to the desired operating mode (left side).

Note!



Do not use the 1-7 menu to check the programmed times-of-use.

If this menu is opened after the times-of-use have been programmed, the schedule programmed for Monday is also adopted for all other days of the week.

1.7 Setting party mode

Using the **Party mode** function, the controller continues or activates rated operation of the controller during the time when the party timer is active, regardless of the adjusted times-of-use. The party timer begins when the rotary switch has been returned to operating mode ☹ "Automatic". When the party timer has elapsed, the party function is reset to 00:00.

The party modes for the different control circuits are adjusted at the rotary switches **one after the other**:

Party timer	Rotary switch	Position
Heating circuit 1/primary heat exchanger circuit	Top	
Heating circuit 2/supplementary heating circuit	Middle	
DHW circuit	Bottom	

Parameter	WE	Range of values
Continue/activate rated operation	0 h	0 to 48 h

Proceed as follows:

Turn appropriate rotary switch to "Party mode".

Display shows: **00:00** or the remaining time of the adjusted party timer

- ⌚ Edit desired length of the one-off time-of-use.

Return the rotary switch to operating mode ☹ "Automatic" (left side).

Note!

Elapsing of the party timer is displayed in steps of 15 minutes.

1.8 Activating extended operating level

After the key number 1999 has been adjusted, the following information can be viewed and edited after the data points listed in section 1.4 have been displayed:

- ▶ Flow rate
- ▶ Heat capacity
- ▶ Public holidays "☾" (editable)
- ▶ Vacation periods "☀" (editable)
- ▶ Valve positions
- ▶ Switching states of the binary inputs
- ▶ Operating hours of the solar pump

Opening the extended operating level:

- ⇒ Switch to configuration and parameter level.
Display shows: **0000**
- (**)** Set key number 1999.
- * Confirm key number.
Display shows: time

Note!

The additional information is no longer displayed when the key number 1999 is adjusted again.

1.8.1 Setting public holidays

On public holidays, the times-of-use specified for Sunday apply. A maximum of 20 public holidays may be entered.

Parameter	WE	Level / Range of values
Public holidays	–	Extended operating level / 01.01 (1 Jan) to 31.12 (31 Dec)

Proceed as follows:

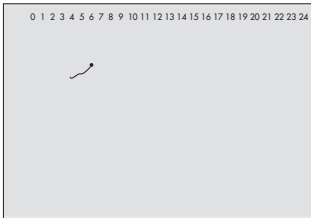

- ⌂ In extended operating mode, select “Public holidays”.
Display shows: ↷
- * Open data point “Public holidays”.
- ⌂ If applicable, select – – – –.
- * Activate editing mode for public holiday. ↷ blinks.
- ⌂ Edit desired public holiday.
- * Confirm public holiday.

To enter additional public holidays, re-select – – – – and repeat the steps in the fields highlighted in gray.

- ⌂ Select **End**.
- * Exit data point “Public holidays”.

Note! Public holidays can also be adjusted in parameter level PA5 (→ section 2.3).

Deleting a public holiday:

- ⌂ Under data point “Public holidays”, select the holiday you wish to delete.
- * Confirm selection.
- ⌂ Select – – – –.
- * Delete the public holiday.

Note!

Public holidays that are not assigned to a specific date should be deleted by the end of the year so that they are not carried on into the following year.

1.8.2 Setting vacation periods

During vacation periods, the controller constantly remains in reduced operating mode. A maximum of 10 vacation periods can be entered. Each vacation period can be assigned separately to the heating circuits Rk1 to Rk2 and/or to the DHW circuit.

Parameter	WE	Level / Range of values
Vacation period (START, STOP)	–	Extended operating level / 01.01 to 31.12

Proceed as follows:



- ⌚ In extended operating level, select “Vacation periods”.
Display shows: 🏠
- * Open data point “Vacation periods”.
Display shows: **START**, --.-- (day.month)
- ⌚ If applicable, select ----.
- * Activate editing mode for start date of vacation period.
🏠 blinks.
- ⌚ Edit start date of vacation period.
- * Confirm start date of vacation period.
- ⌚ Edit end of vacation period.
Display shows: **STOP**, --.-- (day.month)
- * Confirm end date of the vacation period.
Black squares under 1 to 4 at the top of the display indicate the assignment of the vacation periods to the individual heating circuits.
- ⌚ Select the control circuit to which the current vacation period should apply.
 - 1 ■ Current vacation period applies to circuit Rk1
 - 2 ■ Current vacation period applies to circuit Rk2
 - 3 ■ –
 - 4 ■ Current vacation period applies to DHW circuit
 The vacation period can be assigned to a single control circuit or any combination of all three control circuits (Rk1 to Rk2, DHW circuit).

To enter additional vacation periods, re-select ---- and repeat the steps in the fields highlighted in gray.

- ⌂ Select **End**.
 - * Exit data point "Vacation periods".
-

Note! *Vacation periods can also be adjusted in parameter level PA5 (-> section 2.3).*

Deleting vacation periods:

- ⌂ Under "Vacation periods", select the start date of the period you wish to delete.
 - * Confirm selection.
 - ⌂ Select - - - - .
 - * Delete vacation period.
-

Note!





Vacation periods should be deleted by the end of the year so that they are not carried on into the following year.

1.9 Presetting room and DHW temperature set points

For the heating circuits, the desired room temperatures during the day (*Day set point*) and during the night (*Night set point*) can be preset.

In the DHW circuit, the temperature you wish the DHW to be heated to can be adjusted.

The temperature set points for the different control circuits are adjusted at the rotary switches **one after the other**:

Desired temperature set point	Switch	Position
Heating circuit 1/prim. heat exchanger circuit: Day set point	Top	
Heating circuit 1/prim. heat exchanger circuit: Night set point	Top	
Heating circuit 2/supplementary heating circuit: Day set point	Middle	
Heating circuit 2/supplementary heating circuit: Night set point	Middle	
DHW circuit: DHW temperature set point	Bottom	

Parameter	WE	Rotary switch / Range of values
Day set point	20 °C	Top, middle / 0 to 40 °C
Night set point	15 °C	Top, middle / 0 to 40 °C
DHW temperature set point	55 °C	Bottom / Min. to max. DHW temperature

Proceed as follows:

Turn appropriate rotary switch to "Set point temperature".
Display shows: temperature value

⌚ Change temperature value.

Return the rotary switch to the desired operating mode (left side).

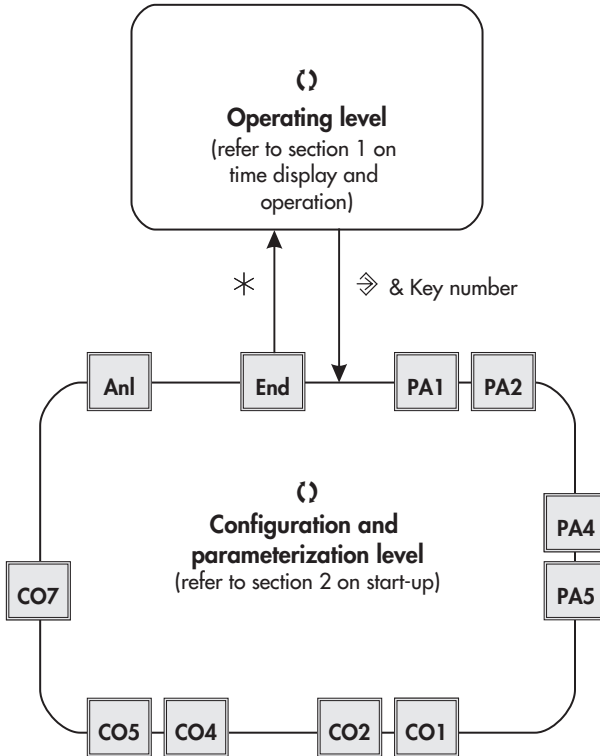

- PA1/CO1: Heating circuit Rk1 ($\overline{\quad}$)
- PA2/CO2: Heating circuit Rk2 ($\overline{\quad}$)
- PA4/CO4: DHW heating
- PA5/CO5: System-wide
- CO7: Device bus
- An1: System code number

Fig. 2 · Level structure of TROVIS 5575

2 Start-up

The modifications of the controller configuration and parameter settings described in this section can only be performed after the valid key number has been adjusted.

The valid key number for initial start-up can be found on page 118. To avoid unauthorized use of the key number, remove the page or make the key number unreadable. In addition, it is possible to adjust a new, customized key number (-> section 7.15).

2.1 Setting the system code number

18 different hydraulic schemes are available. Each system configuration is represented by a system code number. The different schematics are dealt with in section 4. Available controller functions are described in sections 5, 6 and 7.

Changing the system code number resets previously adjusted function blocks to their default values (WE). Function block parameters and parameter level settings remain unchanged. The system code number is adjusted in configuration level.

Proceed as follows:

- ⇒ Switch to configuration and parameter level.
Display shows: **0000**
- Ⓢ Set valid key number.
- * Confirm key number.
Display shows: **PA1**
- Ⓢ Select **Anl.**
- * Activate editing mode for the system code number.
- Ⓢ Edit system code number.
- * Confirm system code number.
Display shows: **End**
- * Return to operating level.

2.2 Activating and deactivating functions

A function is activated via the associated function block. The numbers 0 to 24 in the top row of the display represent the respective function block numbers. When a configuration level is opened, the activated function blocks are indicated by a black square on the right-hand side below the function block number. For more details on function blocks, refer to section 12.1.

The functions are grouped by topics:

- ▶ CO1: Heating circuit 1/primary heat exchanger circuit
- ▶ CO2: Heating circuit 2/supplementary heating circuit
- ▶ CO3: Not used
- ▶ CO4: DHW heating
- ▶ CO5: System-wide functions
- ▶ CO6: Not used
- ▶ CO7: Device bus

Proceed as follows:

- ❖ Switch to configuration and parameter level.
Display shows: **0 0 0 0**
- ⌚ Set valid key number.
- * Confirm key number.
Display shows: **PA1**
- ⌚ Select configuration level (-> Fig. 2).
- * Open configuration level.
- ⌚ Select function block.
Activated function blocks are marked by "- 1".
Deactivated function blocks are marked by "- 0".
- * Activate editing mode for the function block.
F__ blinks.
- ⌚ Activate the function block.
Display shows: **F__ - 1**
An activated function block is indicated by a black square below (right) the function block number in the top row of the controller display.

Or:

- ⌂ Deactivate the function block.
Display shows: **F__ - 0**
- ⌂ * Confirm settings.
If the function block is not closed, further function block parameters can be adjusted.
Proceed as follows:
Make the desired changes and confirm.
If applicable, the next function block parameter is displayed.
Confirm all parameters to exit the opened function block.

To adjust additional function blocks, repeat the steps in the fields highlighted in gray.

- ⌂ Select **End**.
- * Exit configuration level.
- ⌂ Select **End**.
- * Return to operating level.

2.3 Changing parameters

Depending on the adjusted system code number and the activated functions, not all parameters listed in the parameter list in the Appendix (-> section 12.2) might be available.

The parameters are grouped by topics:

- ▶ PA1: Heating circuit 1/primary heat exchanger circuit
- ▶ PA2: Heating circuit 2/supplementary heating circuit
- ▶ PA3: Not used
- ▶ PA4: DHW heating
- ▶ PA5: System-wide functions
- ▶ PA6: Not used
- ▶ PA7: Not used

Proceed as follows:

- ⇒ Switch to configuration and parameter level.
Display shows: **0 0 0 0**
- (↻) Set valid key number.
- * Confirm key number.
Display shows: **PA1**
- (↻) Select parameter level (-> Fig. 2).
- * Open parameter level.
- (↻) Select desired parameter.
- * Activate editing mode for the parameter.
- (↻) Edit the parameter.
- * Confirm the parameter.

To adjust additional parameters, repeat the steps in the fields highlighted in gray.

- (↻) Select **End**.
- * Exit parameter level.
- (↻) Select **End**.
- * Return to operating level.

2.4 Calibrating the sensors

The connected sensors are calibrated in configuration level CO5.

The following applies:

- ▶ CO5 -> F01 - 1 and CO5 -> F02 - 0: Pt 1000 (Pt 100) sensors (default setting)
- ▶ CO5 -> F01 - 0 and CO5 -> F02 - 0: PTC (Pt 100) sensors
- ▶ CO5 -> F01 - 0 and CO5 -> F02 - 1: NTC (Pt 100) sensors
- ▶ CO5 -> F01 - 1 and CO5 -> F02 - 1: Ni 1000 (Pt 100) sensors







The resistance values of the sensors can be found on page 108.

If the temperature values displayed at the controller differ from the actual temperatures, the measured values of all connected sensors can be changed or readjusted. To calibrate a sensor, the currently displayed sensor value must be changed such that it corresponds with a temperature value (reference value) measured directly at the point of measurement.

Sensor calibration is to be activated in CO5 via function block F20.

An improper sensor calibration can be deleted by setting F20 - 0.

Proceed as follows:

- ⇒ Switch to configuration and parameter level. Display shows: **0 0 0 0**
- ⓐ Set valid key number.
- * Confirm key number. Display shows: **PA1**
- ⓐ Select configuration level CO5.
- * Open configuration level CO5.
- ⓐ Select function block F20.
- * Activate editing mode for function block F20.
- ⓐ Select appropriate sensor icon:
 -  Room sensor RF, heating circuits 1, 2
 -  Outdoor sensor AF1
 -  Flow sensor VF, heating circuits 1, 2
 -  Flow sensor VF1, primary heat exchanger circuit
 -  Flow sensor VF2, DHW circuit
 -  Solar collector sensor VF3

 Return flow sensor RüF

 Storage sensor SF1

 Storage sensor SF2

 Storage sensor SF2 for solar circuit

 Flow sensor VF4

- * Display measured value.
Measured value blinks.
- () Correct measured value.
Read the actual temperature directly from the thermometer at the point of measurement and enter this value as reference temperature.
- * Confirm corrected measured value.

Additional sensors are calibrated similarly.

() Select **End**.

* Exit configuration level.

() Select **End**.

() * Return to operating level.

2.5 Resetting to default values

All parameters in parameter levels PA1, PA2 and PA5 adjusted with the rotary switches, except for the maximum flow temperature and the return flow limiting temperature in PA1/PA2, can be reset to their default values (WE).

Proceed as follows:



- ⇒ Switch to configuration and parameter level.
- () Set key number 1991.
- * Confirm key number.

Note! Resetting the parameters to their default values generates an "Err 2" alarm, which is automatically reset shortly after midnight.

3 Manual operation

Switch to manual operating mode to configure all outputs (see wiring diagram in section 11).

Manual operation for the different control circuits is adjusted at the rotary switches:

Manual operation	Rotary switch	Position
Heating circuit 1/primary heat exchanger circuit	Top	
Heating circuit 2/supplementary heating circuit	Middle	
DHW circuit	Bottom	

Proceed as follows:

Turn appropriate rotary switch to  "Manual operation".

Ⓒ Select:

POS_ : Correction value in percent

UP_ : Activation of the circulation pump

SLP: Activation of the storage tank charging pump

* Confirm selection.
Display blinks.

Ⓒ Edit the correction value or activate/deactivate the circulation pump etc.

* Confirm edited settings.
The modified values remain active as long as the controller is in manual mode.

Return the rotary switch to the desired operating mode (left side).

Manual operation of the selected control circuit is deactivated by switching to any other operating mode.

Note!

Simply setting the rotary switch to  "Manual operation" does not have any affect on the outputs. You have to actually enter a correction value or activate/deactivate the pumps to configure the outputs.

*In manual operating mode, **frost protection** (-> section 7.2) is not guaranteed.*

4 Systems

18 different hydraulic schemes are available.

The systems can be designed as primary or secondary systems. The fundamental hydraulic differences between a primary and a secondary system are illustrated in Fig. 3.

- ▶ 1. A mixing valve replaces the heat exchanger in the heating/DHW circuit
- ▶ 2. A storage tank charging pump replaces the primary solenoid/thermoelectric valve

The controller settings do not have to be changed.

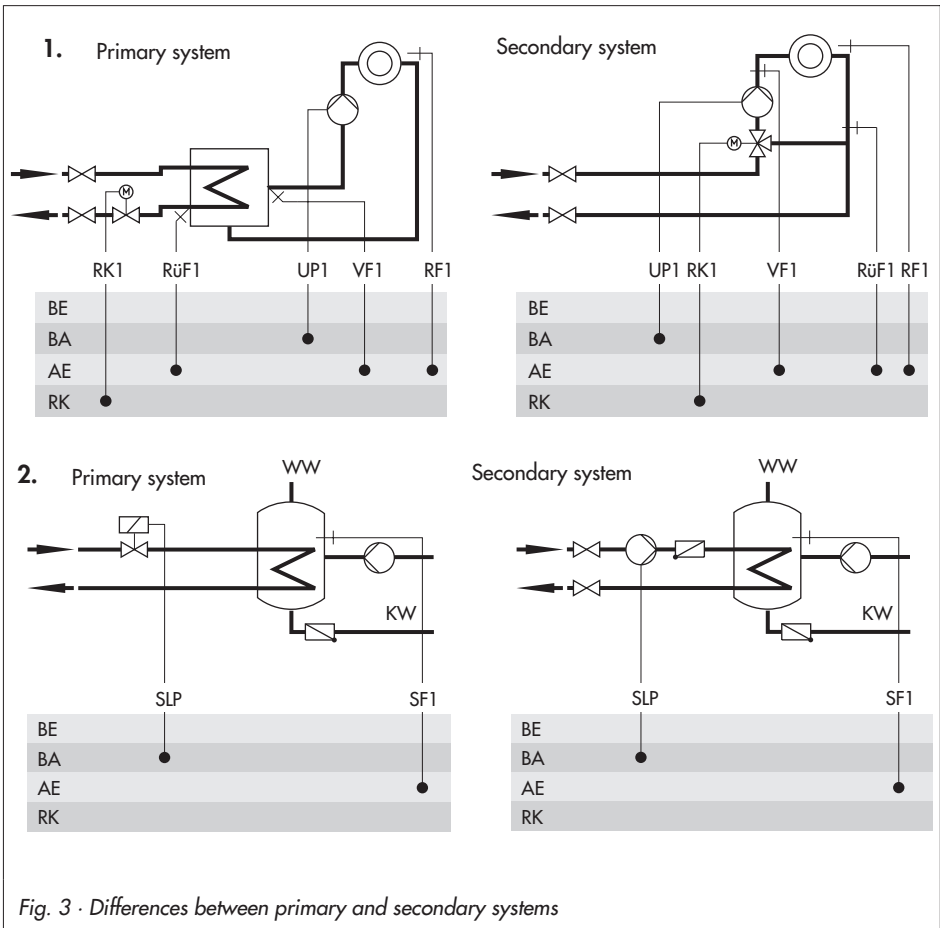

Boiler systems:

Single-stage boiler systems can be configured to include any system whose heating circuits and DHW circuit include just one heat exchanger. These systems are Anl 1.0, 1.5, 1.6, 2.x, 3.0, 4.0 and 4.1.

The boiler can be controlled by an on/off output (CO1 -> F12 - 0).

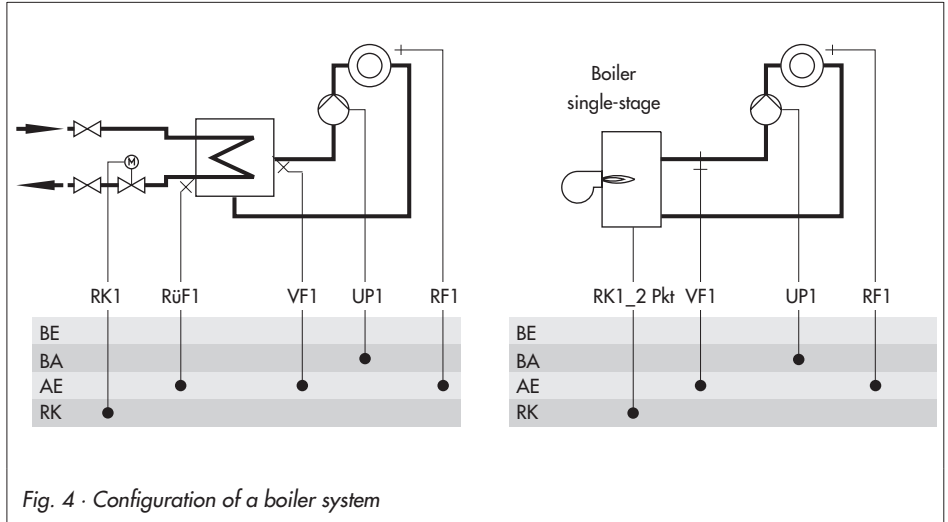

System Anl 1.0

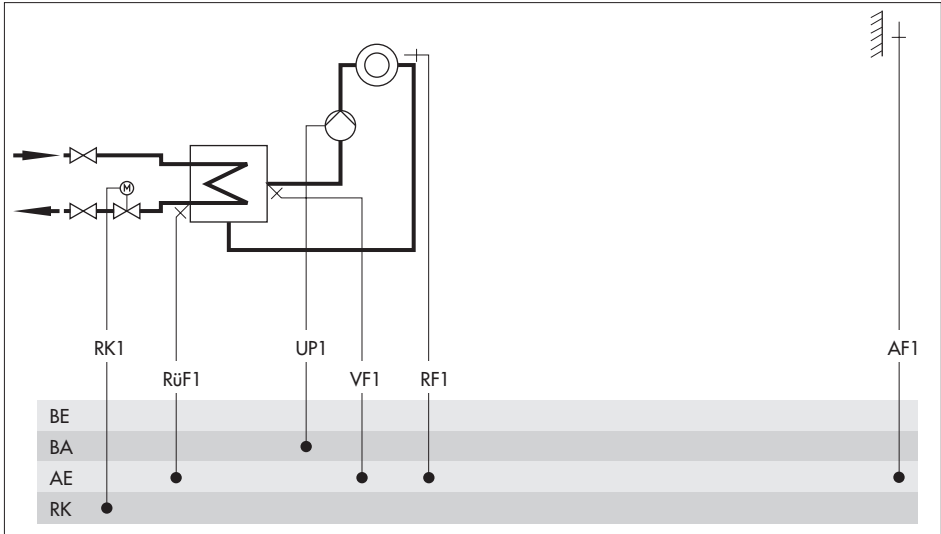

Default settings

CO1 -> F01	- 0 (without RF1)
CO1 -> F02	- 1 (with AF1)
CO1 -> F03	- 1 (with RüF1)

Systems Anl 1.1 to 1.3

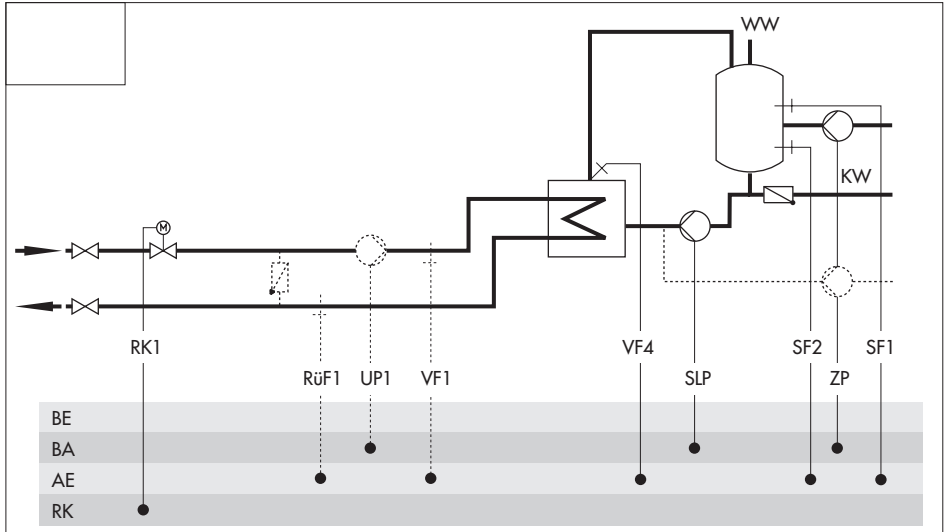

System	Anl 1.1	Anl 1.2	Anl 1.3
Type of DHW heating	Type 1	Type 2	Type 3
1) XX =	SLP	BA9	SLP
Integration of flow sensor VF4	Possible	Possible	-
ZP integration with CO4 -> F10 - 1 (broken line, see cover)	-	Not possible	-
Note	-	Only secondary system	-
Default setting			
CO1 -> F01	- 0 (without RF1)	- 0 (without RF1)	- 0 (without RF1)
CO1 -> F02	- 1 (with AF1)	- 1 (with AF1)	- 1 (with AF1)
CO1 -> F03	- 1 (with RüF1)	- 0 (without RüF1)	- 1 (with RüF1)
CO4 -> F01	- 1 (with SF1)	- 1 (with SF1)	- 1 (with SF1)
CO4 -> F02	- 0 (without SF2)	- 1 (with SF2)	- 0 (without SF2)
CO4 -> F05	- 0 (without VF4)	- 0 (without VF4)	- 0 (without VF4)

System Anl 1.5

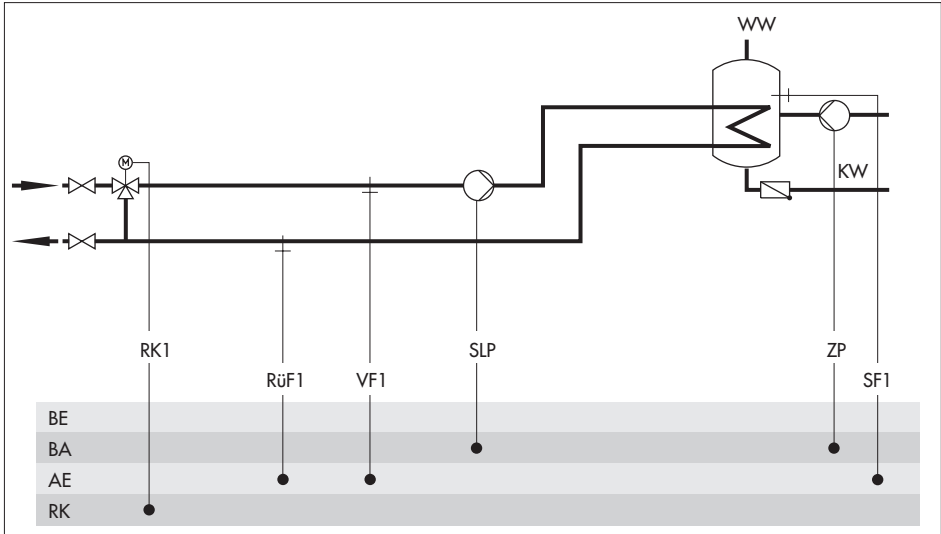

Default setting

CO1 -> F03	- 1 (with RüF1)
CO4 -> F01	- 1 (with SF1)
CO4 -> F02	- 0 (without SF2)

System Anl 1.6

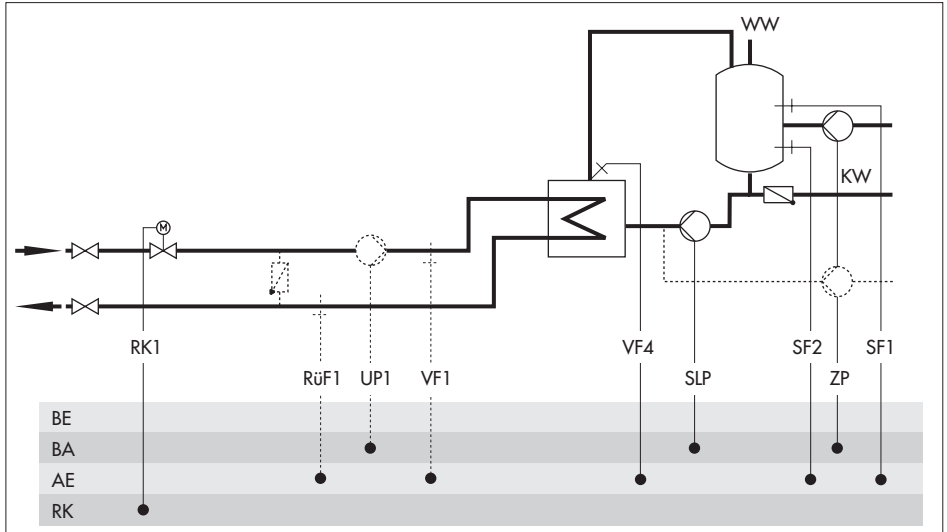

System	Anl 1.6 With pre-control	Anl 1.6 Without pre-control
Integration of VF4, UP1	Possible	Not possible
ZP integration with CO4 -> F10 - 1 (broken line, see cover)	Possible	Possible
Note	-	VF1 takes the position of VF4; RüF1 is to be installed in the heat exchanger
Default setting		
CO1 -> F03		- 1 (with RüF1)
CO4 -> F01		- 1 (with SF1)
CO4 -> F02		- 1 (with SF2)
CO4 -> F05		- 0 (without VF4)

System Anl 2.0

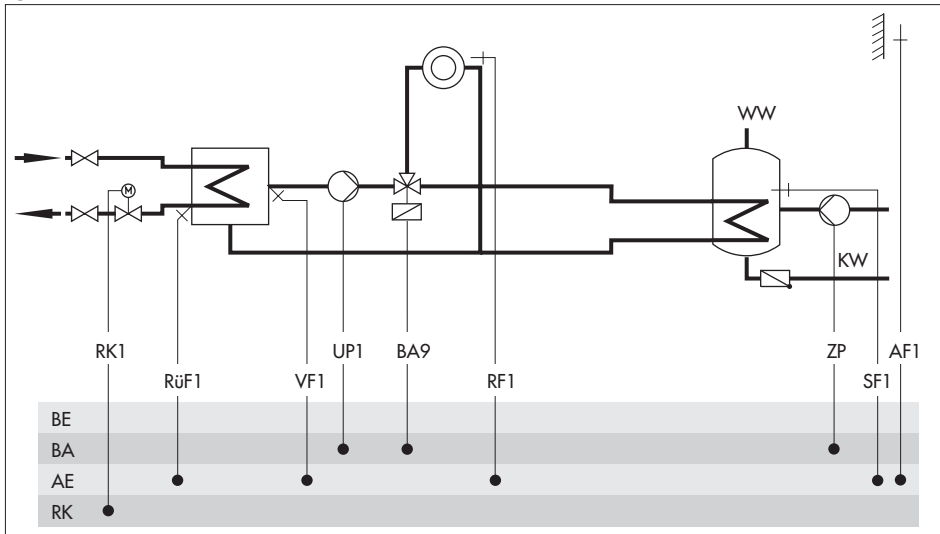

Default setting	
CO1 -> F01	- 0 (without RF1)
CO1 -> F02	- 1 (with AF1)
CO1 -> F03	- 1 (with RüF1)
CO4 -> F01	- 1 (with SF1)
CO4 -> F02	- 0 (without SF2)

Systems Anl 2.1 to 2.3

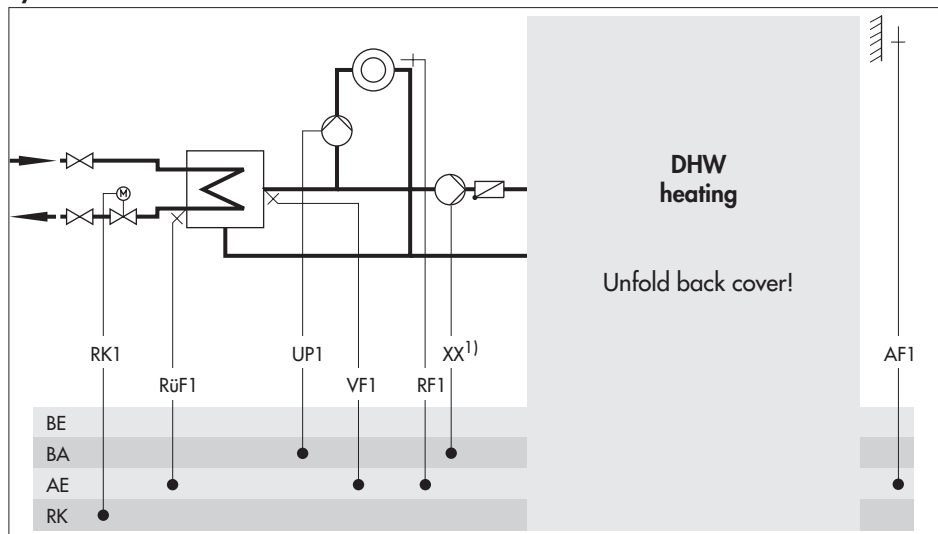

System	Anl 2.1	Anl 2.2	Anl 2.3
Type of DHW heating	Type 1	Type 2	Type 3
¹⁾ XX =	SLP	BA9	SLP
Integration of flow sensor VF4	Not possible	Possible	-
ZP integration with CO4 -> F10 - 1 (broken line, see cover)	-	Not possible	-
Default setting			
CO1 -> F01	- 0 (without RF1)	- 0 (without RF1)	- 0 (without RF1)
CO1 -> F02	- 1 (with AF1)	- 1 (with AF1)	- 1 (with AF1)
CO1 -> F03	- 1 (with RUF1)	- 1 (with RUF1)	- 1 (with RUF1)
CO4 -> F01	- 1 (with SF1)	- 1 (with SF1)	- 1 (with SF1)
CO4 -> F02	- 0 (without SF2)	- 1 (with SF2)	
CO4 -> F05		- 0 (without VF4)	

System Anl 3.0

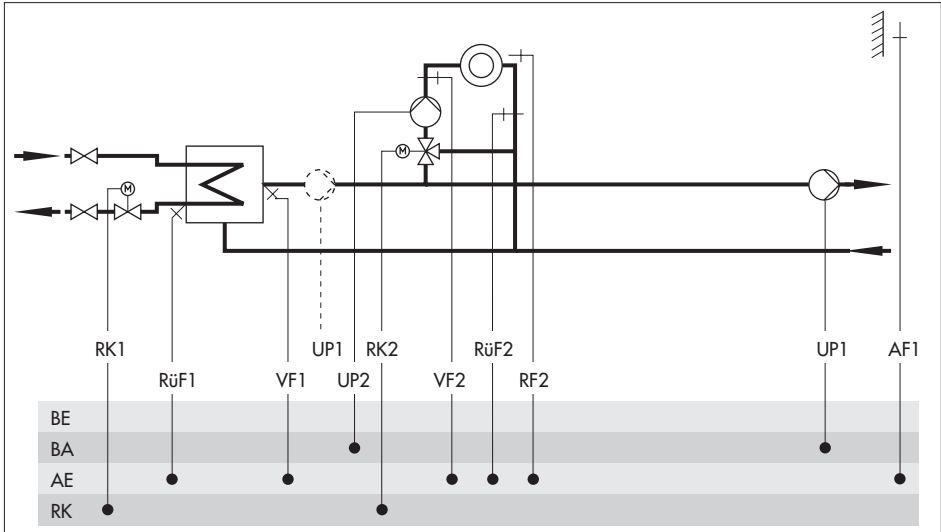

Default setting

CO1 -> F02	- 1 (with AF1)
CO1 -> F03	- 1 (with RüF1)
CO2 -> F01	- 0 (without RF2)
CO2 -> F03	- 0 (without RüF2)

System Anl 4.0

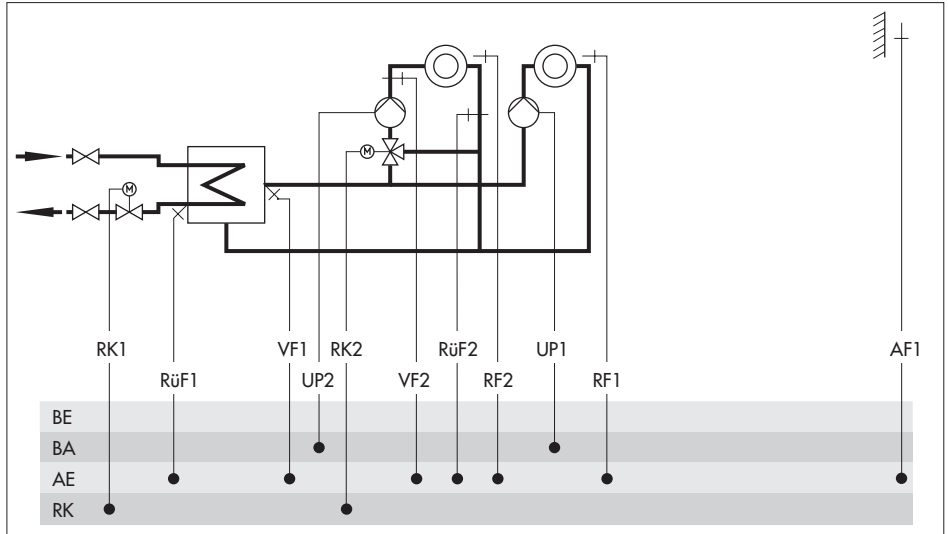

Default setting	
CO1 -> F01	- 0 (without RF1)
CO1 -> F02	- 1 (with AF1)
CO1 -> F03	- 1 (with RüF1)
CO2 -> F01	- 0 (without RF2)
CO2 -> F03	- 0 (without RüF2)

System Anl 4.1

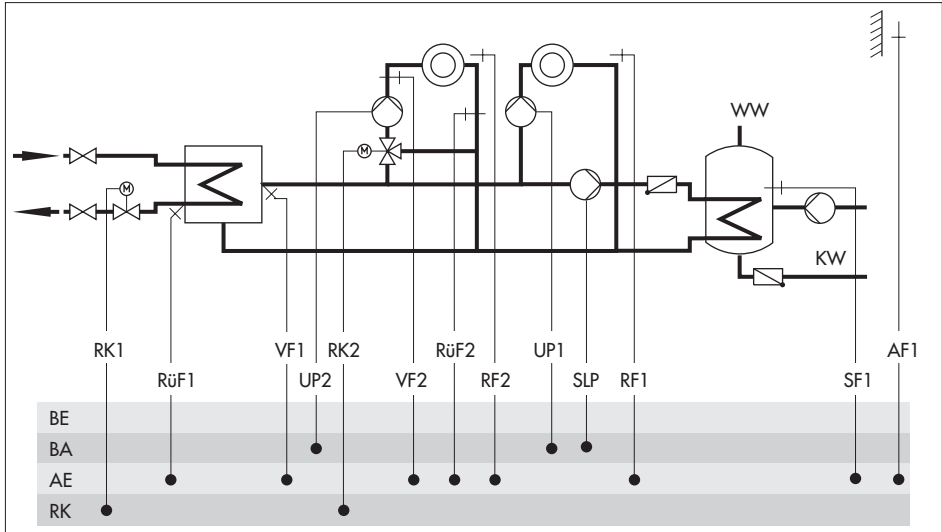

Default setting

CO1 -> F01	- 0 (without RF1)
CO1 -> F02	- 1 (with AF1)
CO1 -> F03	- 1 (with RüF1)
CO2 -> F01	- 0 (without RF2)
CO2 -> F03	- 0 (without RüF2)
CO4 -> F01	- 1 (with SF1)
CO4 -> F02	- 0 (without SF2)

System Anl 4.5

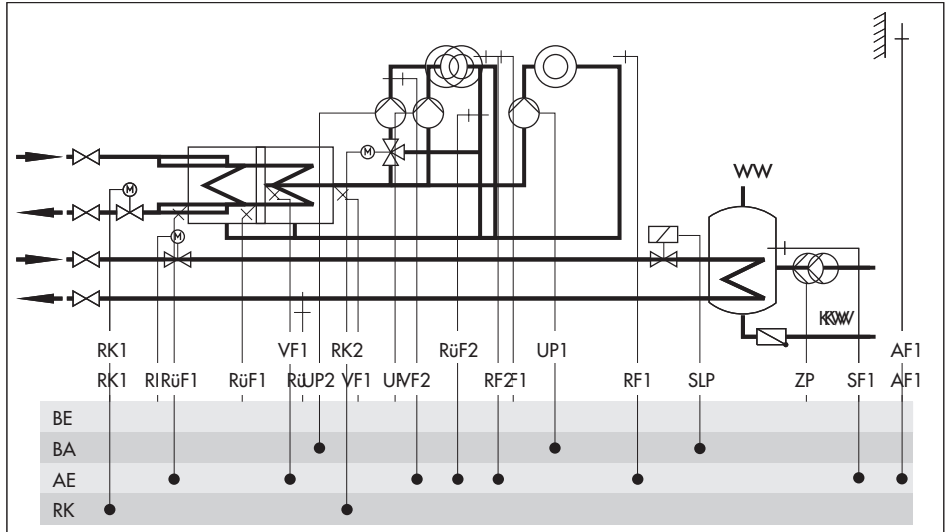

Default setting

CO1 -> F01	- 0 (without RF1)
CO1 -> F02	- 1 (with AF1)
CO1 -> F03	- 1 (with RüF1)
CO2 -> F01	- 0 (without RF2)
CO2 -> F03	- 0 (without RüF2)
CO4 -> F01	- 1 (with SF1)
CO4 -> F02	- 0 (without SF2)

System Anl 10.0

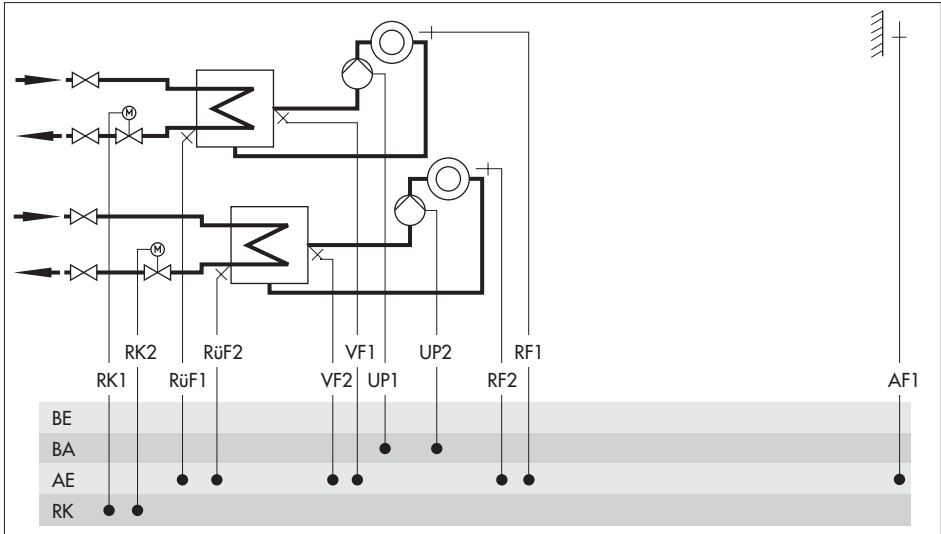

Default setting

CO1 -> F01	- 0 (without RF1)
CO1 -> F02	- 1 (with AF1)
CO1 -> F03	- 1 (with RüF1)
CO2 -> F01	- 0 (without RF2)
CO2 -> F03	- 1 (with RüF2)

System Anl 11.0

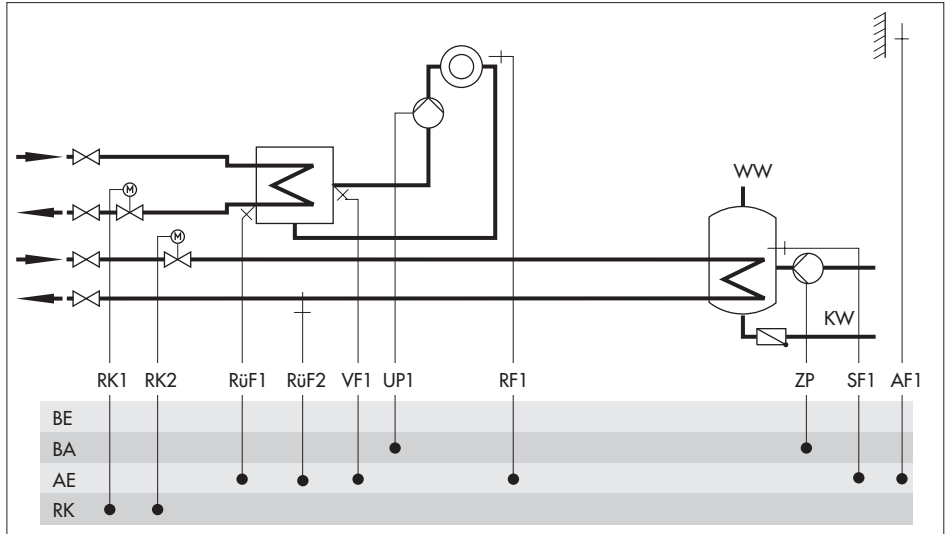

Default setting	
CO1 -> F01	- 0 (without RF1)
CO1 -> F02	- 1 (with AF1)
CO1 -> F03	- 1 (with RüF1)
CO4 -> F03	- 0 (without RüF2)

System Anl 11.1

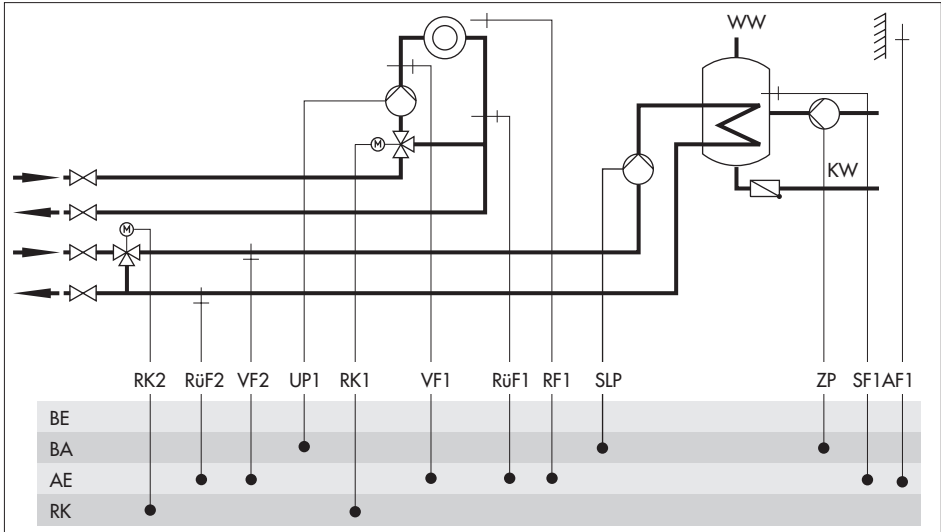

Default setting

CO1 -> F01	- 0 (without RF1)
CO1 -> F02	- 1 (with AF1)
CO1 -> F03	- 1 (with RüF1)
CO4 -> F01	- 1 (with SF1)
CO4 -> F02	- 0 (without SF2)
CO4 -> F03	- 0 (without RüF2)

System Anl 11.2

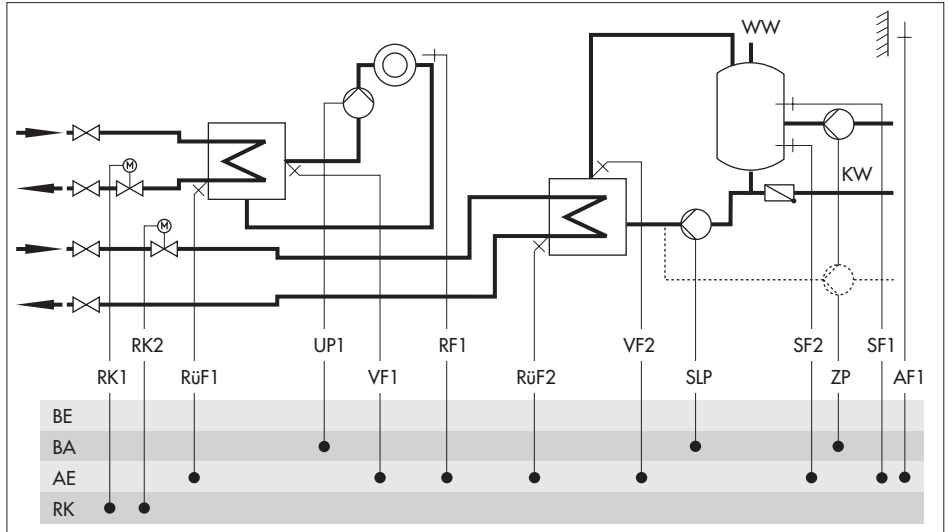

Default setting

CO1 -> F01	- 0 (without RF1)
CO1 -> F02	- 1 (with AF1)
CO1 -> F03	- 1 (with RüF1)
CO4 -> F01	- 1 (with SF1)
CO4 -> F02	- 1 (with SF2)
CO4 -> F03	- 0 (without RüF2)

5 Functions of the heating circuit

Which controller functions are available depends on the selected system code number (Anl).

5.1 Weather-compensated control

When weather-compensated control is used, the flow temperature is adjusted depending on the outdoor temperature. The heating characteristic in the controller defines the flow temperature set point as a function of the outdoor temperature (→ Fig. 5). The outdoor temperature required for weather-compensated control can either be measured at an outdoor sensor or transmitted from a connected device bus.

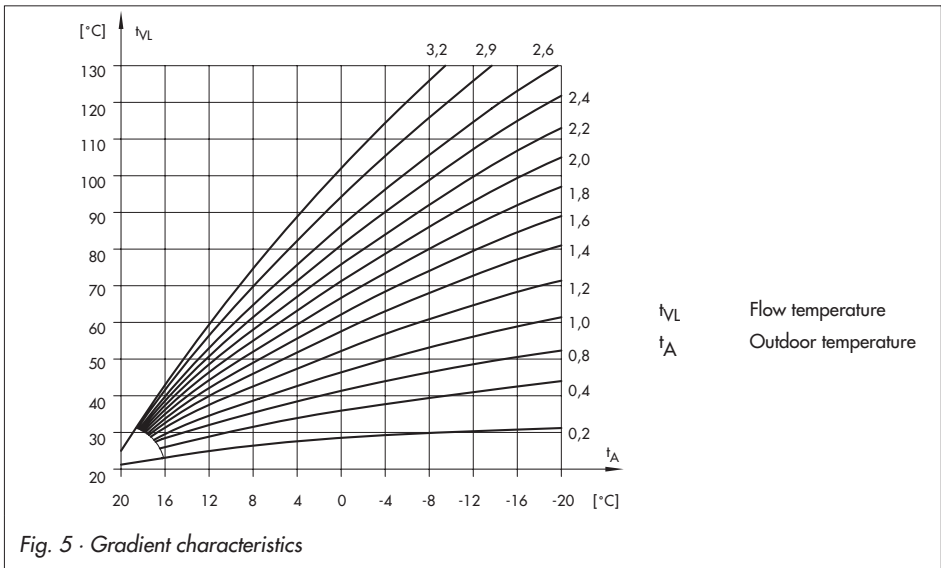

Functions	WE	Configuration
Outdoor sensor AF1	1	CO1 -> F02 - 1

If you wish to alternatively receive the outdoor temperature via the device bus, the following additional configurations must be made:

Device bus	0	CO7 -> F01 - 1; device bus address
Receive value from AF1	0	CO7 -> F07 - 1; register no.

If you wish to receive a separate outdoor temperature for a second heating circuit, the following additional configurations must be made:

Functions	WE	Configuration
Outdoor sensor AF2	0	CO2 -> F02 - 1
Receive value from AF2	0	CO7 -> F09 - 1; register no.

Note!

A value for AF2 independent from value AF1 can only be received over a device bus. A second outdoor sensor cannot be connected.

5.1.1 Gradient characteristic

Basically, the following rule applies: a decrease in the outdoor temperature causes the flow temperature to increase. By varying the parameters *Gradient* and *Level*, you can adapt the characteristic to your individual requirements. Increasing *Gradient* results in a higher flow temperature, decreasing *Gradient* in a lower flow temperature. The parameter *Level* performs a parallel transport of the heating characteristic in upward or downward direction. Outside the times-of-use, reduced set points are used for control:

The reduced flow set point is calculated as the difference between the adjusted values for *Day set point* (rated room temperature) and *Night set point* (reduced room temperature). The parameters *Max. flow temperature* and *Min. flow temperature* mark the upper and lower limits of the flow temperature. A separate gradient characteristic can be selected for the limitation of the return flow temperature.

Examples for adjusting the characteristic:

- ▶ Old building, radiator design 90/70: Gradient approx. 1.8
- ▶ New building, radiator design 70/55: Gradient approx. 1.4
- ▶ New building, radiator design 55/45: Gradient approx. 1.0
- ▶ Underfloor heating depending on arrangement: Gradient smaller 0.5

Note! Particularly for control operation without room sensor, the adjusted room temperatures for day (*Day set point*) and night (*Night set point*) only become effective satisfactorily when the heating characteristic has been adapted to the building/heating surface layout.

Functions	WE	Configuration
4-point characteristic	0	CO1, 2 -> F11 - 0
Parameters	WE	Rotary switch / Range of values
Day set point	20 °C	Top, middle / 0 to 40 °C
Night set point	15 °C	Top, middle / 0 to 40 °C

Parameters	WE	Parameter level / Range of values
Gradient, flow	1,8*	PA1, 2 / 0.2 to 3.2
Level, flow	0 °C	PA1, 2 / -30 to 30 °C
Min. flow temperature	20 °C	PA1, 2 / 5 to 130 °C
Max. flow temperature	90 °C*	PA1, 2 / 5 to 130 °C
* With CO1, 2 -> F05 - 1, the following applies: Gradient, flow / 0.2 to 1.0 (1.0) Max. flow temperature / 5 to 50 °C (50 °C)		

5.1.2 4-point characteristic

The 4-point characteristic allows you to define your own heating characteristic. It is defined by 4 points each for the *Outdoor temperature*, the *Flow temperature*, the *Reduced flow temperature* and the *Return flow temperature*. The parameters *Max. flow temperature* and *Min. flow temperature* mark the upper and lower limits of the flow temperature.

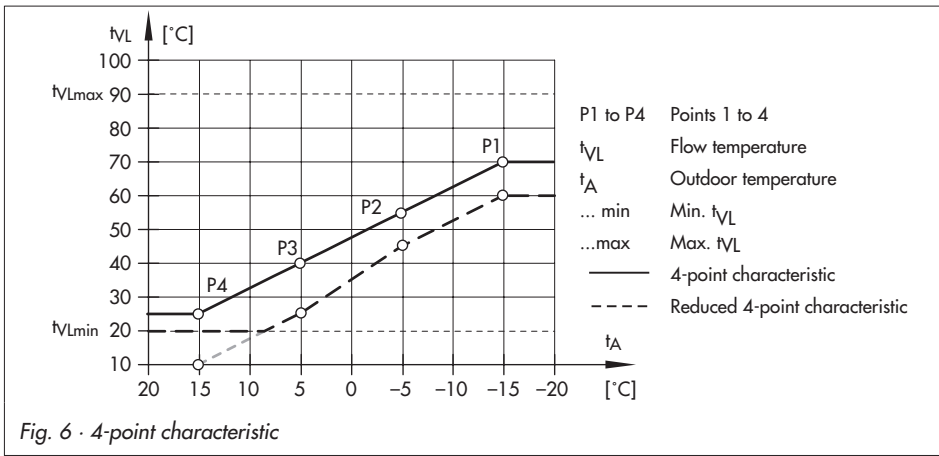

Note!

The parameters *Day set point* and *Night set points* are no longer available when the 4-point characteristic has been selected, provided no additional functions (e.g. **Optimization**, **Flash adaptation**) have been selected.

Functions	WE	Configuration
4-point characteristic	0	CO1, 2 -> F11 - 1

Parameters		WE	Parameter level / Range of values
Outdoor temperature	Point 1	-15 °C	PA1, 2 / -40 to 50 °C
	Point 2	-5 °C	
	Point 3	5 °C	
	Point 4	15 °C	
Flow temperature	Point 1	70 °C	PA1, 2 / 5 to 130 °C
	Point 2	55 °C	
	Point 3	40 °C	
	Point 4	25 °C	
Reduced flow temperature	Point 1	60 °C	PA1, 2 / 5 to 130 °C
	Point 2	40 °C	
	Point 3	20 °C	
	Point 4	20 °C	
Return flow temperature	Point 1 to 4	65 °C	PA1, 2 / 5 to 90 °C
Min. flow temperature		20 °C	PA1, 2 / 5 to 130 °C
Max. flow temperature		90 °C*	PA1, 2 / 5 to 130 °C
* *With CO1, 2 -> F05 - 1, the following applies: Max. flow temperature / 5 to 50 °C (50 °C)			

Note! The **4-point characteristic** function can only be activated when the **Adaptation** function is not active (CO1, 2 -> F08 - 0).

5.2 Fixed set point control

During the times-of-use, the flow temperature can be controlled according to a fixed set point. Outside the times of use, the controller adjusts the reduced flow temperature. Set the desired rated flow temperature as *Day set point*, and the reduced flow temperature as *Night set point*.

Functions	WE	Configuration
Outdoor sensor AF1	1	CO1 -> F02 - 0
Parameter	WE	Rotary switch / Range of values
Day set point	50 °C	Top, middle / Min. to max. flow temperature
Night set point	30 °C	Top, middle / Min. to max. flow temperature
Parameters	WE	Parameter level / Range of values
Min. flow temperature	20 °C	PA1, 2 / 5 to 130 °C
Max. flow temperature	90 °C	PA1, 2 / 5 to 130 °C

Note!

A fixed set point control in heating circuit 2 with CO₂ -> F02 - 0 can only be configured if CO₁ -> F02 - 0 is set as well, because the heating circuit 2 with CO₂ -> F02 - 0 only uses the measured outdoor temperature provided by heating circuit 1.

5.3 Underfloor heating/drying of jointless floors

Using function block setting CO₁, 2 -> F05 - 1, the respective heating circuit is configured as an underfloor heating circuit. In doing so, the controller at first only limits the range of values of the heating characteristic gradient and the maximum flow temperature in parameter levels PA1, 2:

- ▶ range of values of the gradient: 0.2 to 1.0
- ▶ range of values of the maximum flow temperature: 5 to 50 °C

In addition, it is possible to activate the **Drying of jointless floors** function. In connection with this, the function block parameters are listed which appear after activating this function block. They determine the drying process: the first heating up phase always starts with a flow temperature of 25 °C. In the course of 24 hours, this temperature is raised by the value entered in *Temperature rise*, i.e. the default setting causes the temperature to rise to 30 °C within the first 24 hours. If the *Maximum temperature* is reached, it is kept constant for the number of days entered in *Maintaining time for maximum temperature*. The *Temperature reduction* determines the temperature reduction downwards. If the *Temperature reduction* is set to 0, the temperature maintaining phase moves directly to automatic mode.

The drying function is activated by changing the setting *STOP* to *START* after *Temperature reduction*. The course of the drying process can be monitored in the information level over the icon of flow temperature display (°C) of the associated heating circuit:

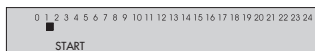

Temperature build-up phase

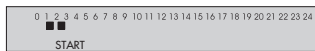

Temperature maintaining phase

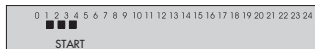

Temperature reducing phase

The drying process has been successfully completed when the additional icon in the flow temperature display goes out after the last phase without the operating fault appearing.

STOP on the display indicates that there has been a deviation of flow temperature of more than 5 °C for longer than 30 minutes. The function is cancelled by the controller in such cases. While *STOP* appears on the display, the controller keeps the flow temperature constant at 25 °C.

A power failure while the drying function is active or when *STOP* appears on the display automatically leads to the drying function restarting.

In systems in which the drying function had to be interrupted due to DHW heating (e.g. Anl 2.1, 4.1), storage tank charging does not occur while the drying function is active, provided it is not used for frost protection of the storage tank.

Note!

The function block parameter can only be accessed when the function has started by deactivating the function block and activating it again.

Functions	WE	Configuration
Underfloor heating	0	CO1, 2 -> F05 - 1
Drying of jointless floors	5 °C/24 h	Temperature rise / 1 to 10 °C/24 h
	45 °C	Maximum temperature / 25 to 60 °C
	4	Maintaining time for max. temperature / 1 to 10 days
	0 °C/24 h	Temperature reduction / 0 to 10 °C/24 h
	STOP	START

5.4 Deactivation depending on outdoor temperature

5.4.1 OT deactivation value in rated operation

If the outdoor temperature exceeds the limit entered in *OT deactivation value in rated operation*, the heating circuit concerned is put out of service immediately. The valve is closed and the pump is switched off after $t = 2 \times$ valve transit time. Heating operation is restarted immediately when the outdoor temperature falls below this value (less 0.5 °C hysteresis).

With the default settings, this means that, during the warm season, the system is switched off at an outdoor temperature of 22 °C.

Parameter	WE	Parameter level / Range of values
OT deactivation value in rated operation	22 °C	PA1, 2 / 0 to 50 °C

5.4.2 OT deactivation value in reduced operation

If the outdoor temperature exceeds the limit value *OT deactivation value in reduced operation*, the heating circuit concerned is put out of service immediately. The valve is closed and the pump is switched off after $t = 2 \times$ valve transit time. Heating operation is restarted immediately when the outdoor temperature falls below this value (less 0.5 °C hysteresis).

Functions of the heating circuit

With the default settings, this means that, at night, the system is switched off at an outdoor temperature of 15 °C to save energy. Nevertheless, remember that the system requires some time in the morning to heat up the building.

Parameter	WE	Parameter level / Range of values
OT deactivation value in reduced operation	15 °C	PA1, 2 / -20 to 50 °C

5.4.3 OT activation value in rated operation

If a heating circuit is in reduced operation (automatic operating mode), the circuit is automatically transferred to rated operation when the outdoor temperature falls below the limit value *OT activation value in rated operation*. When the limit value is exceeded (plus 0.5 °C hysteresis), reduced operation is restarted.

This function is activated at very low temperatures to avoid that the building cools down excessively outside the times-of-use when low outdoor temperatures occur.

Parameter	WE	Parameter level / Range of values
OT activation value in rated operation	-15 °C	PA1, 2 / -20 to 5 °C

5.4.4 Summer mode

Summer mode is activated depending on the mean daytime temperature (measured between 7.00h and 22.00h) during the desired period.

If the mean daytime temperature exceeds the *OT limit value in summer mode* on n successive days, summer mode is activated on the following day. This means that the valves in all heating circuits are closed and the circulation pumps are switched off after $t = 2 \times$ valve transit time. If the mean daytime temperature remains below the *OT limit value in summer mode* on m successive days, summer mode is deactivated on the following day.

Functions	WE	Configuration
Summer mode	0	CO5 -> F04 - 1
	01.06	Start summer mode/ 01.01 (1 Jan) to 31.12 (31 Dec)
	2	No. of days until activation / 1 to 3
	30.09	Stop summer mode / 01.01 to 31.12
	1	No. of days until deactivation / 1 to 3
	18 °C	OT limit value in summer mode / 0 to 30 °C

Note! Summer mode only becomes effective when the controller is in automatic mode (☉).

5.5 Delayed outdoor temperature adaptation

The calculated outdoor temperature is used to determine the flow temperature set point. The heat response is delayed when the outdoor temperature either decreases, increases or increases and decreases. If the outdoor temperature varies by, for example, 12 °C within a very short period of time, the calculated outdoor temperature is adapted to the actual outdoor temperature in small steps. Assuming a *Delay* of 3 °C/h, the adaptation would take $t = \frac{12^{\circ}\text{C}}{3^{\circ}\text{C/h}} = 4\text{h}$.

Note!

The delayed outdoor temperature adaptation helps avoid unnecessary overloads of central heating stations in combination with either overheated buildings occurring, for example, due to warm winds, or temporarily insufficient heating due to the outdoor sensor being exposed to direct sunshine.

In operating level, the outdoor temperature blinks on the display while delayed outdoor temperature adaptation is active. The calculated outdoor temperature is displayed.

Functions	WE	Configuration
Delayed OT adaptation when OT decreases	0	CO5 -> F05 - 1
Delayed OT adaptation when OT increases	0	CO5 -> F06 - 1
	3 °C/h	Delay / 1 to 6 °C/h

5.6 Remote operation

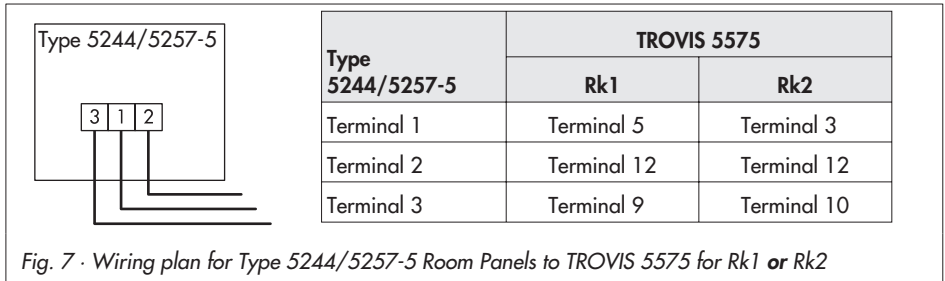

Apart from measuring the room temperature, the Type 5244 Room Panel (PTC room sensor) and Type 5257-5 Room Panel (Pt 1000 sensor) provide the following opportunities of influencing the control process:

Functions of the heating circuit

- ▶ Selection of the operating mode: – Automatic mode
– Day mode
– Night mode
- ▶ Set point correction: during rated operation, the room temperature set point can be increased or reduced by up to 5 °C using a continuously adjustable rotary knob.

When the room sensor is activated and the remote operation (room panel) is connected and activated, the measured room temperature is displayed. Nevertheless, it is not used for control unless the **Optimization**, **Adaptation** or **Flash adaptation** functions have been activated.

Alternatively, the TROVIS 5570 Room Panel can be connected over the device bus (→ section 7.11.5).

Function	WE	Configuration
Rooms sensors RF1/2	0	CO1, 2 -> F01 - 1

If the TROVIS 5570 Room Panel is to be used instead, the additional configurations below must be made:

Device bus	0	CO7 -> F01 - 1; device bus address
TROVIS 5570 Room Panel in Rk1	0	CO7 -> F03 - 1; device bus address
TROVIS 5570 Room Panel in Rk2	0	CO7 -> F04 - 1; device bus address

Note!

The Day set point set by the rotary switch remains unaffected by set point corrections performed at the room panel. Only the calculated flow temperature set point or the room temperature set point (for flash adaptation) are adapted accordingly.

The evaluation of a room temperature sensor connected to the terminals RF is not possible for this control circuit when a TROVIS 5570 Room Panel is configured.

5.7 Optimization

This function requires the use of a room sensor. Depending on the building characteristics, the controller determines and adapts the required preheating time (maximum 8 hours) to ensure that the desired *Day set point* (rated room temperature) has been reached in the reference room when the time-of-use starts. During the preheating period, the controller heats with the max. flow temperature. This temperature is built up in steps of 10 °C. As soon as the *Day set point* has been reached, weather-compensated control is activated.

Depending on the room sensors, the controller switches off the heating system up to one hour before the time-of-use ends. The controller chooses the deactivation time such that the room temperature does not drop significantly below the desired value until the time-of-use ends. During the preheating period and the premature deactivation of the heating system, the

icons ☀ or 🌙 blink on the display. Outside the times-of-use, the controller monitors the *Night set point* (reduced room temperature). When the temperature falls below the night set point, the controller heats with the max. flow temperature until the measured room temperature exceeds the adjusted value by 1 °C.

Note!

Direct sunshine can cause the room temperature to increase and thus result in the premature deactivation of the heating system.

When the room temperature decreases while the heating system is temporarily outside its times-of-use, this can prematurely cause the controller to heat up to the adjusted Day set point.

Functions	WE	Configuration
Room sensors RF1/2	0	CO1, 2 -> F01 - 1
Outdoor sensors AF1	1	CO1 -> F02 - 1
Optimization	0	CO1, 2 -> F07 - 1
Parameters	WE	Rotary switch / Range of values
Day set point	20 °C	Top, middle / 0 to 40 °C
Night set point	15 °C	Top, middle / 0 to 40 °C

5.8 Flash adaptation

To achieve that the controller reacts immediately to room temperature deviations, adjust the function block setting CO1, 2 -> F09 - 1.

Flash adaptation counteracts room temperature deviations by increasing or decreasing the flow temperature by up to 30 °C. The *Cycle time* determines the intervals at which the flow temperature set point is corrected by 1 °C.

Note!

Cooling loads, such as drafts or open windows, affect the control process!

Rooms may be temporarily overheated when the cooling load has been eliminated!

Functions	WE	Configuration
Room sensors RF1/2	0	CO1, 2 -> F01 - 1
Flash adaptation	0	CO1, 2 -> F09 - 1
	20 min	Cycle time / 1 to 100 min
Parameters	WE	Rotary switch / Range of values
Day set point	20 °C	Top, middle / 0 to 40 °C
Night set point	15 °C	Top, middle / 0 to 40 °C

5.8.1 Flash adaptation without outdoor sensor (room temperature dependent)

The flow temperature control starts with *Flow day set point* in rated operation or with *Flow night set point* in reduced operation as no set points calculated using characteristics exist without an outdoor sensor. In rated operation, the heating is switched off when the room temperature exceeds the *Day set point* by 2 °C. In reduced operation, the heating is switched off when the room temperature exceeds the *Night set point* by 2 °C. If the *Cycle time* is set to 1 minute, the current correction value is not lost on changing from rated to reduced operation or vice versa. Instead, it is integrated into the calculation of the *Flow day set point* or *Flow night set point*.

Functions	WE	Configuration
Room sensors RF1/2	0	CO1, 2 -> F01 - 1
Outdoor sensor AF 1/2	1	CO1, 2 -> F02 - 0
Flash adaptation	0	CO1, 2 -> F09 - 1
	20 min	Cycle time / 1 to 100 min
Parameters	WE	Rotary switch / Range of values
Day set point	20 °C	Top, middle, bottom / 0 to 40 °C
Night set point	15 °C	Top, middle, bottom / 0 to 40 °C
Parameters	WE	Parameter level / Range of values
Flow day set point	50 °C	PA1, 2 / 5 to 130 °C
Flow night set point	30 °C	PA1, 2 / 5 to 130 °C

5.9 Adaptation

The controller is capable of automatically adapting the heating characteristic to the building characteristics, provided a gradient characteristic has been set (CO1, 2 -> F11 - 0). The reference room, where the room sensor is located, represents the entire building and is monitored to ensure that the room set point (*Day set point*) is maintained. When the mean measured room temperature in rated operation deviates from the adjusted set point, the heating characteristic is modified accordingly for the following time-of-use. The corrected value is displayed in parameter levels PA1, 2 under *Gradient, flow*.

Functions	WE	Configuration
Room sensors RF1/2	0	CO1, 2 -> F01 - 1
Outdoor sensors AF1/2	1	CO1, 2 -> F02 - 1
Adaptation	0	CO1, 2 -> F08 - 1
4-point characteristic	0	CO1, 2 -> F11 - 0
Parameters	WE	Rotary switch / Range of values
Day set point	20 °C	Top, middle / 0 to 40 °C
Night set point	15 °C	Top, middle / 0 to 40 °C

6 Functions of the DHW circuit

6.1 DHW heating in the storage tank system

Start storage tank charging

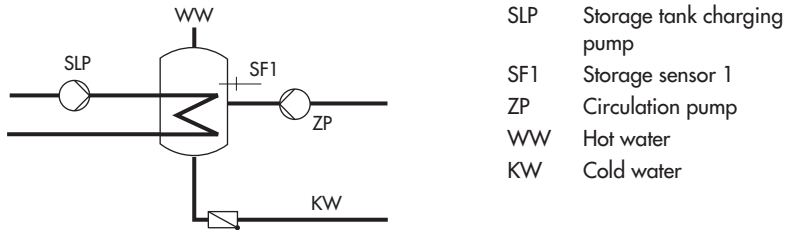

Fig. 8 · Schematics of a storage tank system

The controller begins charging the storage tank when the water temperature measured at sensor SF1 falls below the *DHW temperature set point* by 0.1 °C. If the flow temperature in the system exceeds the desired charging temperature, the controller tries to reduce the flow temperature in the heating circuit for up to 3 minutes before the storage tank charging pump is activated. When there is no heating operation or when the flow temperature in the system is lower, the storage tank charging pump is switched on immediately.

If the function CO4 -> F15 - 1 (**SLP ON depending on return flow temperature**) is activated, the primary valve is opened without simultaneously operating the storage tank charging pump. The storage tank charging pump is not switched on before the primary return flow temperature has reached the temperature currently measured at storage sensor SF1.

This function enables storage tank charging when the heating system is switched off, e.g. in summer mode, without cooling down the storage tank first by filling it with cold flow water. The storage tank charging pump does not start operation before a sufficiently high temperature has been reached at the heat exchanger.

Note!

Instead of the parameter DHW temperature, the Charging temperature can be set as the absolute value at the rotary switch if a storage tank thermostat is used.

Time-controlled switchover of storage tank sensors

By configuring a second storage tank sensor SF2 over the function block CO4 -> F19 - 1, it is possible to determine that the storage tank sensor SF1 is used for day mode in the DHW circuit and that the storage tank sensor SF2 is used for night mode. As a result, different storage tank volumes can be kept at a constant temperature according to a time schedule, and also at different temperatures if the *DHW set point* and *Sustained DHW temperature* differ from one another.

Stop storage tank charging

The controller stops charging the storage tank when the water temperature measured at sensor SF1 has reached the temperature $T = \text{DHW temperature} + \text{hysteresis}$. When there is no heating operation or when the flow temperature demand in the system is lower, the corresponding valve is closed.

The storage tank charging pump is switched off after $t = \text{lag time of storage tank charging pump} \times \text{valve transit time}$.

With the default settings, the temperature in the storage tank is increased by 5 °C to reach 50 °C when the the storage tank temperature falls below 45 °C. The charging temperature is calculated from the DHW temperature (45 °C) plus the charging temperature boost (10 °C), which equals 55 °C. When the storage tank has been charged, the heating valve is closed and the charging pump continues operation for the time t (lag). Outside the times-of-use, the storage tank is only charged when the the temperature falls below 40 °C (*Sustained DHW temperature*). In this case, the tank is charged with a charging temperature of 50 °C until 45 °C is reached in the tank.

Functions	WE	Configuration
Storage sensor SF1	1	CO4 -> F01 - 1
Storage sensor SF2		CO4 -> F02 (- 1 when CO4 -> F19 - 1)
SLP ON depending on return flow temperature	0	CO4 -> F15
Time-controlled switchover of storage sensors	0	CO4 -> F19 (- 1 only when CO4 -> F02 - 1)
Parameter	WE	Rotary switch / Range of values
DHW temperature set point or charging temperature set point with CO4 -> F01 - 0	55 °C	Bottom / Min. to max. DHW temperature
Parameters	WE	Parameter level / Range of values
Min. DHW temperature*	40 °C	PA4 / 20 to 90 °C
Max. DHW temperature*	60 °C	PA4 / 20 to 90 °C
Hysteresis**	5 °C	PA4 / 0 to 30 °C
Charging temperature boost***	10 °C	PA4 / 0 to 50 °C

Functions of the DHW circuit

Parameters	WE	Parameter level / Range of values
Lag of storage tank charging pump	0.5	PA4 / 0.1 to 10.0
Sustained DHW temperature	40 °C	PA4 / 20 to 90 °C

- * Parameters serve as limitation of the adjustment range for the DHW temperature to be set at the rotary switch
- ** Deactivation value $T = \text{DHW temperature} + \text{hysteresis}$
- *** Charging temperature $T = \text{DHW temperature} + \text{charging temperature boost}$

6.1.1 DHW circuit additionally controlled by a globe valve

In system An1 11.1, the following version with globe valve can be configured instead of the three-way valve control in the DHW circuit:

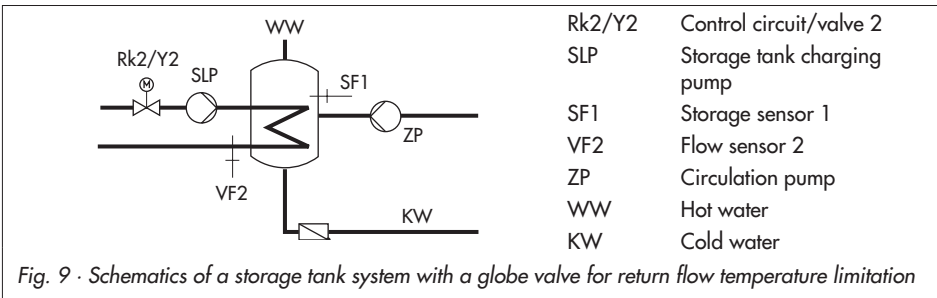

Globe valve and temperature sensor VF2 are used exclusively for return flow temperature limitation in the schematics shown above. The pre-control circuit provides at least the same flow temperature as in the standard schematic version which is calculated from *DHW temperature set point + Charging temperature boost + Primary exchanger control boost set point*.

The functions and parameters of the DHW heating in the storage tank system are upgraded by the following settings:

Function	WE	Configuration
DHW circuit additionally controlled by a globe valve	0	CO4 -> F20 - 1

Parameter	WE	Parameter level / Range of values
Maximum return flow temperature	65 °C	PA4 / 20 to 90 °C

6.2 DHW heating in the storage tank charging system

Start storage tank charging

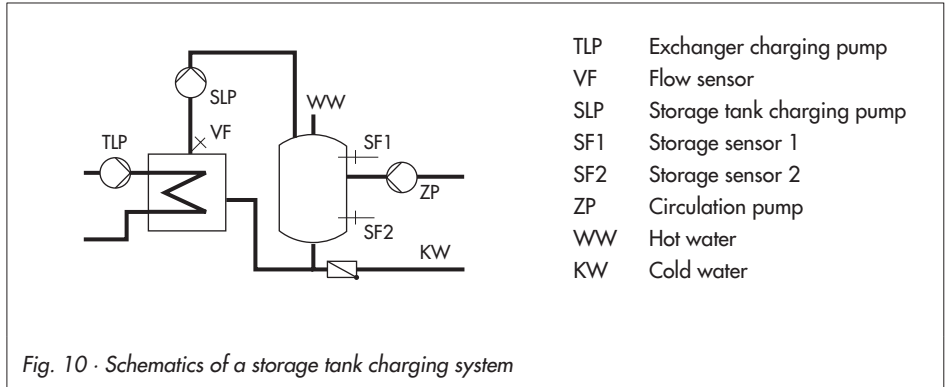

Fig. 10 · Schematics of a storage tank charging system

The controller begins charging the storage tank when the water temperature measured at sensor SF1 falls below the *DHW temperature set point* by 0.1 °C. If the flow temperature in the system exceeds the desired charging temperature, the controller tries to reduce the flow temperature in the heating circuit for up to 3 minutes before the exchanger charging pump is activated together with the storage tank charging pump.

When there is no heating operation or when the flow temperature in the system is lower, the exchanger charging pump is switched on immediately. If the temperature currently measured at sensor SF1 is reached at sensor VF, the storage tank charging pump is switched on.

If a storage tank thermostat is used, the storage tank charging pump is switched on when the temperature $T = \text{charging temperature} - 5\text{ °C}$ is reached at sensor VF.

Note!

Instead of the DHW temperature parameter, the Charging temperature can be adjusted as absolute value at the rotary switch if a storage tank thermostat is used.

When the flow sensor VF4 is activated, the set point in the heat exchanger circuit is influenced by the system deviation in the storage tank charging circuit upon activation of the storage tank charging pump: if the temperature measured at flow sensor VF4 is lower than the desired charging temperature, the set point in the heat exchanger circuit is increased by 1 °C each minute.

When the set point in the heat exchanger charging circuit reaches the *Max. charging temperature* value, the set point is no longer increased. "Err 4" alarm is generated.

Note!

The set point in the heat exchanger circuit which is valid at the end of the charging cycle will be used again at the beginning of the next cycle.

If times-of-times have been set for DHW heating, the *Set point DHW temperature* adjusted at the rotary switch is applied during these times-of-use. Outside the times-of-use, the *Sustained DHW temperature* is used. This does not apply when a storage tank thermostat is used.

Time-controlled switchover of storage tank sensors

By configuring a second storage tank sensor SF2 over the function block CO4 -> F19 -1, it is possible to determine that the storage tank sensor SF1 is used for day mode in the DHW circuit and that the storage tank sensor SF2 is used for night mode. As a result, different storage tank volumes can be kept at a constant temperature according to a time schedule, and also to different temperatures if the *DHW set point* and *Sustained DHW temperature* differ from one another.

Stop storage tank charging

The controller stops charging the storage tank when the water temperature measured at sensor SF2 has reached the temperature $T = \text{DHW temperature} + \text{hysteresis}$. To do so, the exchanger charging pump is switched off first.

When there is no heating operation or when the flow temperature demand in the system is lower, the corresponding valve is closed. The storage tank charging pump is switched off after $t = \text{lag time of storage tank charging pump} \times \text{valve transit time}$.

Functions	WE	Configuration
Storage tank sensor SF1	1	CO4 -> F01 - 1
Storage tank sensor SF2	1	CO4 -> F02 - 1
Flow sensor VF4	0	CO4 -> F05
Time-controlled switchover of storage sensors	0	CO4 -> F19
Parameter	WE	Rotary switch / Range of values
DHW temperature set point or charging temperature set point with CO4 -> F01 - 0	55 °C	Bottom /Min. to max. DHW temperature
Parameters	WE	Parameter level / Range of values
Min. DHW temperature*	40 °C	PA4 / 20 to 90 °C
Max. DHW temperature*	60 °C	PA4 / 20 to 90 °C

Parameters	WE	Parameter level / Range of values
Hysteresis**	5 °C	PA4 / 0 to 30 °C
Charging temperature boost***	10 °C	PA4 / 0 to 50 °C
Max. charging temperature	80 °C	PA4 / 20 to 130 °C (only with VF4)
Lag of storage tank charging pump	0.5	PA4 / 0.1 to 10.0
Sustained DHW temperature	40 °C	PA4 / 20 to 90 °C

* Parameters serve as limitation of the adjustment range for the DHW temperature to be set at the rotary switch

** Deactivation value $T = \text{DHW temperature} + \text{hysteresis}$

*** Charging temperature $T = \text{DHW temperature} + \text{charging temperature boost}$

6.3 DHW heating with solar system

The systems An1 1.3 and 2.3 include a solar system for DHW heating. In these systems, the difference between the temperatures measured at storage sensor SF2 and the sensor at the solar collector VF3 is determined. The *Solar pump ON* parameter determines the minimum temperature difference between sensors VF3 and SF2 required to activate the solar pump. If the temperature difference falls below the value of *Solar pump OFF*, the solar pump is switched off. Basically, the solar pump is also switched off when the water temperature measured at sensor SF2 has reached the *Max. storage tank temperature*.

Note!

The times-of-use of the DHW circuit do not affect the operation of the solar system.

After the key number 1999 has been entered, the operating hours of the solar pump are displayed in extended operating level.

Parameters	WE	Parameter level/Range of values
Solar pump ON	10 °C	PA4 / 1 to 30 °C
Solar pump OFF	3 °C	PA4 / 0 to 30 °C
Max. storage tank temperature	80 °C	PA4 / 20 to 90 °C

6.4 Intermediate heating operation

This function is only available in systems Anl 2.x, 4.1 and 4.5. With the setting CO4 -> F07 - 1, heating operation of the UP1 heating circuit is reactivated for a period of 10 minutes after 20 minutes of priority (heating deactivated during DHW heating). By setting CO4 -> F07 - 0, storage tank charging is given unlimited priority over the heating operation in the UP1 heating circuit.

Function	WE	Configuration
Intermediate heating	1	CO4 -> F07 - 1

6.5 Parallel pump operation

This function is only available in systems Anl 2.1 to 2.3, 4.1 and 4.5. With the setting CO4 -> F06 - 1, the circulation pump UP1 remains switched on during DHW heating unless certain operating situations occur. These situations include, for example, those when the current flow temperature demand of the pump circuit is lower than the adjusted *Flow limit temperature for parallel pump operation*. In this case, the controller applies priority operation, if necessary with intermediate heating. Once a parallel pump operation cycle has been activated and the time for *Stop parallel operation in case of deviation* has elapsed, system deviations greater than 5 °C cause the controller to suspend parallel operation for 10 minutes and to apply priority operation. Setting the *Stop parallel operation in case of deviation* to 0 minutes leads to a parallel operation once initiated remaining regardless of a deviation.

Function	WE	Configuration
Parallel pump operation	0	CO4 -> F06 - 1
	10 min 40 °C	Stop parallel operation in case of deviation / 0 to 10 min Flow limit temperature for parallel pump operation / 20 to 90 °C

6.6 Circulation pump operation during storage tank charging

With the setting CO4 -> F11 - 1, the circulation pump continues operation according to the set schedule even during storage tank charging.

With the setting CO4 -> F11 - 0, the circulation pump is switched off as soon as the storage tank charging pump is activated. The circulation pump returns to operate according to schedule when the storage tank charging pump has been switched off again.

Function	WE	Configuration
Circulation pump operation during storage tank charging	0	CO4 -> F11

6.7 Priority operation

In many district heating systems with primary DHW heating, the allotted amount of water is only intended to supply the heating system. As a result, the capacity required for DHW heating needs to be taken from the heating system when great heating loads occur; and this, until DHW heating has been concluded.

Nevertheless, heating operation is not to be interrupted simply. Only the amount of energy required for DHW heating is to be deducted. This can be achieved by using the priority functions **Reverse control** and **Set-back operation**.

6.7.1 Reverse control

In all systems with DHW heating and at least one heating circuit with control valve, DHW heating can be given priority by applying reverse control. With the setting CO4 -> F08 - 1, the charging temperature can be monitored. In systems without the sensor VFx in the DHW circuit (e.g. Anl 4.5, Anl 11.0), the temperature directly at the storage sensor SF1 is monitored. If system deviations occur after the time for *Activate priority in case of deviation* has elapsed, the set point of the heating circuit with the control valve is gradually reduced each minute until the flow temperature set point has reached 5 °C at the minimum. How strongly the controller responds is determined by the *Correction factor*.

Functions	WE	Configuration
Priority through reverse control	0	CO4 -> F08 - 1
	2 min	Activate priority in case of deviation / 2 to 10 min
	1.0	Correction factor / 0.1 to 10.0
Priority through set-back operation	0	CO4 -> F09 - 0

6.7.2 Set-back operation

In all systems with DHW heating and at least one heating circuit with control valve, DHW heating can be given priority by applying set-back operation. With the setting CO4 -> F08 - 1, the charging temperature can be monitored. In systems without the sensor VFx in the DHW circuit (e.g. Anl 4.5, Anl 11.0), the temperature directly at the storage sensor SF1 is monitored. If system deviations occur after the time for *Activate priority in case of deviation* has elapsed, set-back or reduced operation is activated for the heating circuit with the control valve.

Functions	WE	Configuration
Priority through reverse control	0	CO4 -> F08 - 0
Priority through set-back operation	0 2 min	CO4 -> F09 - 1 Activate priority in case of deviation / 2 to 10 min

6.8 Forced charging of the DHW storage tank

To provide the full room heating performance when the time-of-use of the heating circuits begins, existing storage tanks are charged one hour before the time-of-use of the heating circuits starts. For the individual controller, this means that storage tank charging is activated when the water temperature in the storage tank falls below the adjusted deactivation value of $T = \text{DHW temperature} + \text{hysteresis}$. The forced charging of the storage tank does not take place when the DHW circuit is not used at the beginning of the time-of-use set for the heating circuit(s).

Note!

This function is not available when a storage tank thermostat is used.

6.9 Thermal disinfection of the DHW storage tank

In all systems with DHW heating, the DHW storage tank is thermally disinfected on a selected *Day of the week* or every day. The storage tank is heated up, taking into account the *Charging temperature boost* parameter to the adjusted *Disinfection temperature*. Disinfection begins at the adjusted *Start time* and, at the latest, ends at the specified *Stop time*.

If the *Start time* and *Stop time* are set to the identical time, the process is controlled according to the programmed time schedule depending on the switching state of a binary input (terminal 03/12, only possible without SF2/RF2). The activated, optionally also deactivated binary input starts the thermal disinfection. It stops at the latest when the switching state of the binary input next changes.

When the *Disinfection temperature* has not been reached before the end of the thermal disinfection cycle, "Err 3" alarm is generated. The alarm is automatically reset when the *Disinfection temperature* is properly reached during the following thermal disinfection cycle.

Thermal disinfection for preventing legionella infection causes

- ▶ high return flow temperatures during the disinfection cycle (return flow temperature limitation suspended),
- ▶ high storage temperatures after thermal disinfection has been concluded,
- ▶ lime scale (possibly), which can have a negative effect on heat exchanger performance.

Note!

This function is not available when a storage tank thermostat is used.

Controllers that are linked over a device bus are subjected to return flow temperature limitation in the primary control circuit even during the thermal disinfection in a secondary controller.

Functions	WE	Configuration
Storage sensor SF1	1	CO4 -> F01 - 1
Thermal disinfection	0	CO4 -> F14 - 1
	3	Day of the week / 1-7, 1, 2, ..., 7 with 1-7 = every day, 1 = Monday, ..., 7 = Sunday
	0:00	Start time / 0:00h to 23:45h; in steps of 15 minutes
	4:00	Stop time / 0:00h to 23:45h; in steps of 15 minutes
	70 °C	Disinfection temperature / 60 to 90 °C
	1	bE = 1, 0 (start of disinfection with BE (term. 03/12 = ON, OFF; only applies when Start time = Stop time)

7 System-wide functions

7.1 Automatic summer time/winter time changeover

The clock is automatically adjusted on the last Sunday in March at 2.00h and on the last Sunday in October at 3.00h.

Function	WE	Configuration
Summer time/winter time changeover	1	CO5 -> F08 - 1

7.2 Frost protection

Depending on the switching state of the function block CO5 -> F09, frost protection measures are taken when the outdoor temperature falls below +3 °C. On selecting the frost protection program I, the *Frost protection limit* can be adjusted. The hysteresis to cancel the frost protection measures is always 1 °C.

- ▶ Frost protection program I (restricted frost protection): frost protection measures are taken only when all heating circuits in the system are in stand-by mode. The circulation pumps are forcedly switched on and their flow temperature set points are adjusted to 10 °C. The circulation pump in the DHW circuit is switched on forcedly only when the heating operation of all heating circuits is suspended in optimizing mode, or when stand-by mode has been adjusted at the mode selector switch. Nevertheless, the storage tank is always recharged to 10 °C if the storage tank temperature falls below 5 °C.
- ▶ Frost protection program II: the heating circuit circulation pumps are always switched on forcedly. The flow temperature set points of all heating circuits currently in stand-by mode are set to +10 °C. In the DHW circuit, the circulation pump is always activated. If the storage tank temperature falls below +5 °C, the storage tank is recharged to +10 °C.

Functions	WE	Configuration
Frost protection program I		CO5 -> F09 - 0
	3 °C	Frost protection limit / -15 to 3 °C
Frost protection program II		CO5 -> F09 - 1

Note!

Frost protection operation of a pump, a heating circuit or the DHW circuit is active only when the frost protection icon ❄️ is indicated on the display.

Fixed set point control without outdoor temperature sensor does not include frost protection in stand-by mode.

7.3 Forced operation of the pumps

When the heating circuit pumps have not been activated for 24 hours, forced operation of the pumps is started between 12.02h and 12.03h. This is done to avoid that the pumps get stuck when they are not operated for a longer period of time. In the DHW circuit, the circulation pump is operated between 12.04h and 12.05h, the other pumps between 12.05h and 12.06h.

7.4 Return flow temperature limitation

The temperature difference between the flow and return flow indicates how well the energy is used: the greater the difference, the higher the efficiency. A return flow sensor is sufficient to evaluate the temperature difference when the network flow temperatures are determined. The return flow temperature can be limited either to a value depending on the outdoor temperature (variable) or to a fixed value. When the temperature measured at return flow sensor RüF exceeds the limit value, the set point of the flow temperature (flow temperature of the heating, charging temperature) is reduced. As a result, the primary flow rate is reduced and the return flow temperature falls. In systems Anl 2.x and 4.1, the *Max. return flow temperature* parameter (PA4 level) is used for limitation in the primary circuit during DHW heating if it is greater than the parameter valid for the primary circuit. The *Limiting factor* determines how strongly the controller responds when the limit values are exceeded in either direction (PI algorithm).

If just P-action is to be implemented, set CO5 -> F16 - 1. This allows the I-action in the return flow temperature limitation algorithm of all control circuits of the controller to be deactivated. The set point reading (flow temperature of the heating, charging temperature) blinks to indicate that a return flow limitation is active in the control circuit concerned.

Note!

Using weather-compensated control with gradient characteristic, the return flow temperature is limited to a fixed value by equating the parameters Return flow temperature foot and Max. return flow temperature (PA1, 2).

Note!

If CO5 -> F00 - 1 is indicated, access to the return flow, flow rate and heat capacity settings are locked.

System-wide functions

Function	WE	Configuration
Return flow sensors RüF1/2	1	CO1, 2, 4 -> F03 - 1
	1.0	Limiting factor/ 0.1 to 10.0
Return flow temperature limitation with P algorithm	0	CO5 -> F16
Parameters	WE	Parameter level/Range of values
Gradient, return flow	1,2	PA1, 2 / 0.2 to 3.2
Level, return flow	0.0 °C	PA1, 2 / -30 to 30 °C
Return flow temperature foot	65 °C	PA1, 2 / 5 to 90 °C
Max. return flow temperature	65 °C	PA1, 2, 4 / 5 to 90 °C

or

Parameter	WE	Parameter level/Range of values
Return flow temp. points 1 to 4	65 °C	PA1, 2 / 5 to 90 °C

Note!

To ensure that the preset return flow temperature limiting value can be met, make sure that

- the heating characteristic is not adjusted to ascent too steeply,
- the circulation pumps are not adjusted to run too rapidly,
- the heating systems have been calibrated.

7.5 Condensate accumulation control

Activate the **Limit deviation for OPEN signal** function to start up condensate accumulation plants, in particular to avoid problematic excess temperatures. The controller response to set point deviations which cause the primary valve to open is attenuated. The controller response to set point deviations which cause the control valve to close remains unaffected.

Function	WE	Configuration
Limit deviation for OPEN signal	0	CO1, 2, 4 -> F13 - 1
	2 °C	Max. system deviation / 2 to 10 °C

Note!

The condensate accumulation control function can only be activated when no on/off control has been configured, i.e. when CO1, 2, 4 -> F12 - 1 applies.

7.6 Three-step control

The flow temperature can be controlled using a PI algorithm. The valve reacts to pulses that the controller emits upon an existing system deviation. The length of the first pulse, in particular, depends on the extent of the system deviation and the selected *Proportional gain* K_P (the pulse length increases as K_P increases). The pulse and pause lengths change continuously until the system deviation has been eliminated. The pause length between the single pulses is greatly influenced by the *Reset time* T_N (the pause length increases as T_N increases). The *Transit time* T_Y specifies the time required by the valve to travel through the range of 0 to 100 %.

Functions	WE	Configuration
Control type three-step	1	CO1, 2, 4 -> F12 - 1, Rk_
	2.0	K_P (proportional gain) / 0.1 to 50.0
	120 s	T_N (reset time) / 1 to 999 sec
	45 s	T_Y (transit time) / 15, 30, ..., 240 sec

7.7 On/off control

The flow temperature can be controlled, for example, by activating and deactivating a boiler. The controller switches on the boiler when the flow temperature falls below the set point by $T = 0.5 \times \text{hysteresis}$. When the set point is exceeded by $T = 0.5 \times \text{hysteresis}$, the boiler is switched off again. The greater the value you choose for *Hysteresis*, the lower will be the activation/deactivation frequency. By setting the *Minimum ON time*, an activated boiler remains switched on during this period regardless of the flow temperature fluctuations. Similarly, a deactivated boiler will remain switched off regardless of the flow temperature fluctuations if the *Min. OFF time* has been specified.

Functions	WE	Configuration
Control type on/off	1	CO1, 2, 4 -> F12 - 0
	5 °C	Hysteresis / 1 to 30 °C
	2 min	Min. ON time / 0 to 10 min
	2 min	Min. OFF time / 0 to 10 min

7.8 Releasing a control loop over the binary input

The release of a control loop using the binary output only becomes effective when the respective control loop is in automatic operating mode (icon ☺). The released control loop always works in automatic mode; the deactivated control loop behaves as if it were transferred to stand-by mode.

It remains active, however, in any case for processing of external demand. The control loop can be released via the binary input when the binary input is either open (bE = 0) or closed (bE = 1).

Note!

In systems with supplementary heating circuit without a valve (Anl 2.x, 4.x), BE1 only influences the operation of this heating circuit. In system Anl 3.0, BE1 influences the operation of the entire controller (except for processing of an external demand).

Functions	WE	Configuration
Release Rk 1 at BE1	0	CO1 -> F14 - 1
	1	bE = 1, 0
Release Rk 2 at BE2	0	CO2 -> F14 - 1
	1	bE = 1, 0

7.9 Processing of external demand in Rk1

The controller can process binary or analog requests for an externally required signal by a more complex secondary system, provided the following requirements are met: the system is configured without storage tank sensor SF2 or room sensor RF2 and an analog request can be matched to "0 to 10 V corresponds with 0 to 120 °C flow temperature". In other words: flow temperature demand 12 °C/V. Analog requests below 10 °C (< 0.8 V input signal) are not processed; overvoltage generates a maximum flow set point of 130 °C. An additional processing of requests for an externally required signal using the device bus cannot be configured.

Note!

Overheating may occur in the heating circuits of the primary controller without control valve.

Excessive charging temperatures in DHW circuits without control valve controlled by the primary controller are excluded when the default settings of the controller are used: while storage tank charging is active, no flow temperature higher than the charging temperature is adjusted by the primary controller. Nevertheless, if the **Priority for external demand** function is activated, the external demand is also processed during storage tank charging.

Function	WE	Configuration
Priority for external demand	0	CO4 -> F16 - 1

Processing of external demand, binary

Regardless of the operating mode set for control loop Rk1 – except manual mode –, the flow temperature specified as *Set point for binary demand processing* is adjusted in control loop Rk1 when the binary input is either open (bE = 0) or closed (bE = 1).

Functions	WE	Configuration
Processing of external demand in Rk1	0	CO1 -> F15 - 1
Processing of external demand, 0 to 10 V	0	CO1 -> F16 - 0
Processing of external demand, binary	0	CO1 -> F17 - 1
	1	bE= 1, 0
Receive external demand	0	CO7 -> F15 - 0
Parameter	WE	Parameter level/Range of values
Set point for binary demand processing	40 °C	PA1 / 5 to 130 °C

Processing of external demand, 0 to 10 V

Regardless of the operating mode set for control loop Rk1 – except manual mode –, the controller regulates at least the flow temperature corresponding with the 0 to 10 V signal.

Functions	WE	Configuration
Processing of external demand in Rk1	0	CO1 -> F15 - 1
Processing of external demand, 0 to 10 V	0	CO1 -> F16 - 1
Processing of external demand, binary	0	CO1 -> F17 - 0
Receive external demand	0	CO7 -> F15 - 0
Parameter	WE	Parameter level/Range of values
Set point boost of primary exchanger control	5 °C	PA1 / 5 to 130 °C

7.10 Flow rate/heat capacity limitation in Rk1

Flow rate/heat capacity limitation can be implemented based on a pulse or standardized signal of 0/4 to 20 mA provided by the heat meter. This only applies in plants without SF2, RF2 and without processing of an external demand 0 to 10 V. Particularly when a standardized signal is applied, a heat meter (flow meter) with high measuring accuracy is required. Make sure that the controller is supplied with updated measured values in intervals of max. 5 seconds. In both cases (pulse or standardized signal), there are three different operating situations:

- ▶ A system with simultaneous room heating and DHW heating requires maximum energy.
- ▶ A system with a fully charged storage tank which performs only room heating requires less energy.
- ▶ A system which suspends room heating during DHW heating requires less energy.

As a result, three different maximum limit values can be specified:

- ▶ *Max. limit value* to determine the absolute upper limit
- ▶ *Max. limit value heating* for exclusive operation of the room heating
- ▶ *Max. limit value DHW* for exclusive operation of the DHW heating

In all systems without DHW heating or without heating circuit, only the *Max. limit value* for the flow rate or capacity can be set.

Note!

The limiting function is not available in systems Anl 10.

7.10.1 Limitation using pulse input

Depending on the operating situation, a heat meter with pulse output connected to input WMZ/Bed (terminals 03/13) can be used to limit either the flow rate or the capacity in the system. All limit values are given in the unit "pulses per hour" [pulse/h]. As a result, the controller does not distinguish between a flow rate pulse signal or a capacity pulse signal. As the displayed current pulse rate P [pulse/h] (→ Extended operating level, key number 1999) is calculated depending on the interval between the received pulses, it is natural that the controller cannot react immediately to all rapid flow rate or capacity changes which occur in the system.

When the pulse rate reaches the current *Max. limit value*, the flow set point of control loop Rk1 is reduced. How strongly the controller responds is determined by the *Limiting factor*.

Example to determine the limit value:

If a capacity of 30 kW is to be limited, the following limit value must be set for a heat meter with an output of one pulse per kilowatt-hour:

$$P = \frac{30 \text{ kW}}{1 \text{ kWh / pulse}} = 30 \text{ pulse / h}$$

Note!

If CO5 -> F00 - 1 is indicated, access to the return flow, flow rate and heat capacity settings are locked.

Functions	WE	Configuration
Flow rate limitation (capacity limitation) in Rk1 with pulses at input WMZ	0	CO5 -> F10 - 1
	15 pulse/h	Max. limit value/ 3 to 500 pulse/h
	15 pulse/h	Max. limit value heating* / 3 to 500 pulse/h
	15 pulse/h	Max. limit value DHW* / 3 to 500 pulse/h
	1.0	Limiting factor / 0.1 to 10.0
Flow rate limitation in Rk1 with 0/4 to 20 mA at input WMZ	0	CO5 -> F11 - 0
* Not in Anl 1.0, 1.5, 1.6, 3.0, 4.0 and 11.x		

7.10.2 Limitation using 0/4 to 20 mA signal

Depending on the operating situation, a heat meter at input WMZ/Bed (terminals 03/13) with a 0/4 to 20 mA output (connected in parallel to input WMZ/Bed using 50 Ω) can be used to limit the flow rate in the system. All limit values are given in the unit "cubic meters per hour" [m³/h]. As a result, both a *Lower measuring range value* 0 or 4 mA and an *Upper measuring range value* must be adjusted in unit [m³/h]. The current flow rate in [m³/h] is displayed in extended operating level (-> key number 1999).

When the flow rate reaches the current *Max. limit value*, the flow set point of control loop RK1 is reduced. How strongly the controller responds is determined by the *Limiting factor*.

Note!

If CO5 -> F00 - 1 is indicated, access to the return flow, flow rate and heat capacity settings are locked.

System-wide functions

Functions	WE	Configuration
Flow rate limitation (capacity limitation) in Rk1 with pulses at input WMZ	0	CO5 -> F10 - 0
Flow rate limitation in Rk1 using 0/4 to 20 mA at input WMZ	0	CO5 -> F11 - 1
	1.5 m ³ /h	Lower measuring range value/ 0, 4 mA
	1.5 m ³ /h	Upper meas. range value 20 mA / 0.01 to 650 m ³ /h
	1.5 m ³ /h	Max. limit value / 0.01 to 650 m ³ /h
	1.5 m ³ /h	Max. limit value heating* / 0.01 to 650 m ³ /h
	1.5 m ³ /h	Max. limit value DHW* / 0.01 to 650 m ³ /h
	1.0	Limiting factor / 0.1 to 10.0

* Not in Anl 1.0, 1.5, 1.6, 3.0, 4.0 and 11.x

7.10.3 Creep feed rate limitation over binary input

It is possible to report to the controller when the creep feed rate has fallen below a certain level by using a limit switch of the primary valve connected to the terminals 04/12. Either the open (bE=0) binary input or the closed binary input (bE=1) can be assigned to inform about the creep feed rate status. Shortly after the alert, the controller closes the valve Rk1. As soon as the flow temperature falls below the set point by more than 5 °C after the valve has been closed, control operation is started again.

Function	WE	Parameter level/Range of values
Creep feed rate limitation	0	CO5 -> F12 - 1
	1	bE = 0, 1

7.11 Device bus

Using the device bus, it is possible to connect up to 32 device (from Series 55xx). For connection, the TROVIS 5575 Controller is, above all, equipped with the terminals 14/15. No attention must be paid to the polarity of the device bus wiring.

Activate the device bus and specify the device bus address for each device. Note that the device bus address 1 is to be set for just one controller in the system, and that all device bus addresses must be unique. The controller with device bus address 1 implements the required bus terminator for the system.

Once the controllers have been connected and preset, additional functions can be configured. These partly application-specific functions include:

- ▶ Requesting and processing an external demand (-> page 75)
- ▶ Sending and receiving outdoor temperatures (-> page 76)
- ▶ Synchronizing the clock (-> page 77)
- ▶ Priority over all controllers (-> page 77)
- ▶ Connecting a TROVIS 5570 Room Panel (-> page 78)
- ▶ Display error alarms issued by the device bus (-> page 78)

7.11.1 Requesting and processing an external demand

In general, the controller which controls the primary valve or boiler (= primary controller) in a system of coupled controllers will process the demand of all subsequent controllers (= secondary controllers). As a result, the primary controller must be configured to receive this demand. Usually, the secondary controllers are configured such that they send their maximum flow set point to the primary controller. In special cases, however, it might happen that only the set point of a control circuit is to be sent. The appropriate function blocks to do so are also available. After the desired function blocks have been activated, you must specify a register number.

The following applies: in a system of coupled controllers which are hydraulically supplied by a primary controller all controllers (primary and secondary controllers) must be adjusted to the same *Register no.* for the "demand registers". A controller which is configured to receive a demand in register no. 5 will not process a demand sent to register no. 6. The primary controller compares the received requested demands and its own requested demands and supplies the system with the required flow temperature – if necessary increased by the value of the parameter *Set point boost for primary exchanger control*.

Note!

Overheating may occur in the heating circuits of the primary controller without control valve.

Primary controller:

Functions	WE	Configuration
Device bus	0	CO7 -> F01 - 1
	32	Device bus address
Receive external demand	0	CO7 -> F15 - 1
	5	Register no. / 5 to 64
Parameter	WE	Parameter level/Range of values
Set point boost for primary exchanger control	5 °C	PA1 / 0 to 50 °C

Secondary controller:

Functions	WE	Configuration
Device bus	0	CO7 -> F01 - 1
	32	Device bus address
Send flow set point Rk1	0	CO7 -> F10 - 1*
Send flow set point Rk2	0	CO7 -> F11 - 1*
Send flow set point DHW	0	CO7 -> F13 - 1*
Send max. flow set point	0	CO7 -> F14 - 1*
	5	*Register no. / 5 to 64

Note!

The register number specifies the location where the flow set points are saved in the primary controller. As a result, the register no. set in the secondary controller for CO7 -> F10 to F14 must be the same as the register no. adjusted under CO7 -> F15 in the primary controller.

Excessive charging temperatures in DHW circuits without control valve controlled by the primary controller are excluded when the default settings of the controller are used: while storage tank charging is active, no flow temperature higher than the charging temperature is adjusted by the primary controller.

Nevertheless, if the **Priority for external demand** function is activated, the external demand is also processed during storage tank charging.

Function	WE	Configuration
Priority for external demand	0	CO4 -> F16 - 1

7.11.2 Sending and receiving outdoor temperatures

Controllers equipped with an outdoor sensor can be configured to supply other controllers with the measured outdoor temperature via the device bus. This enables weather-compensated control even in systems which do not have their own outdoor sensor.

Functions	WE	Configuration
Device bus	0	CO7 -> F01 - 1
	32	Device bus address
Send value AF1	0	CO7 -> F06 - 1
	1	Register no. / 1 to 4

Functions	WE	Configuration
Receive value AF1	0	CO7 -> F07 - 1
	1	Register no. / 1 to 4
Receive value AF2 (receive an outdoor temp. independent of Rk1)	0	CO7 -> F09 - 1
	2	Register no. / 2 to 4

Note!

The register no. for the outdoor temperature AF1 or AF2 must be the same for the sending and the receiving controller.

7.11.3 Synchronizing the clock

One controller in a system of coupled controllers should perform the **Clock synchronization** function. This controller sends its system time once every 24 hours to all other controllers via the device bus.

Regardless of this function, the system time of all controllers is adapted immediately when the time setting of one controller is changed.

Functions	WE	Configuration
Device bus	0	CO7 -> F01 - 1
	32	Device bus address
Clock synchronization	0	CO7 -> F02 - 1

7.11.4 Priority over all controllers

It is possible to put the heating circuits of other controllers out of operation while the DHW heating is active when the controllers are linked to one another over a device bus. Controllers which should operate a DHW heating with priority need to issue *DHW heating active* alert. Controllers that have heating circuits which should be deactivated during this active DHW heating need to have the configuration **Receive release of Rk_** for the heating circuits concerned. If the circuit is just a DHW circuit which should influence one or more heating circuits, they need to be assigned with the identical register number. In the case that there are several DHW circuits in the system, selected heating circuits can only react to one or other active DHW circuits by assigning different register numbers.

If a secondary heating circuit with a valve should be put out of operation, the heating circuit valve concerned is closed; the heating circuit circulation pump remains in operation.

If a secondary heating circuit without a valve should be put out of operation, for example, in system Anl 2.x, just its heating circuit circulation pump and not the primary circuit Rk1 is put out of operation by using the configuration **Receive release of Rk1**.

Functions	WE	Configuration
Device bus	0	CO7 -> F01 - 1; Device bus address
Send "DHW heating active"	0	CO7 -> F20 - 1*
Receive release of Rk1	0	CO7 -> F21 - 1*
Receive release of Rk2	0	CO7 -> F22 - 1*
	32	*Register no. / 5 to 64

7.11.5 Connecting a TROVIS 5570 Room Panel

A TROVIS 5570 Room Panel (accessory) can be connected to the TROVIS 5575 Controller to measure the room temperature and for remote operation of a heating circuit. The room panel enables direct access to the operating mode and controller time settings as well as to all relevant parameters of a heating circuit. Additionally, the room temperature, the outdoor temperature and, if applicable, other data points can be viewed.

The terminals 5 and 6 of the room panel are connected to terminals 14 and 15 of the controller. The room panel is supplied with operating voltage (terminals 1 and 2 of the room panel (12 to 26.5 V AC/15 to 36 V DC) at the point of installation.

Functions	WE	Configuration
Device bus	0	CO7 -> F01 - 1
	32	Device bus address
TROVIS 5570 Room Panel in Rk1	0	CO7 -> F03 - 1
	32	Device bus address
TROVIS 5570 Room Panel in Rk2	0	CO7 -> F04 - 1
	32	Device bus address

7.11.6 Display error alarms issued by the device bus

Error alarms over device bus do cause controllers with an active modem function already in the default setting to dial the control station. However, the error alarms issued by the device bus are not displayed by controllers configured in this way. The setting CO7 -> F16 - 1 causes these controllers to react to the error alarms from the device bus by generating the Err 5 alarm as long as the faults of the other device bus participants exist. The black squares under the corresponding numbers at the top of the display indicate which device bus address is defective for the first 23 device bus participants.

Function	WE	Configuration
Display error alarms issued by the device bus	0	CO7 -> F16 - 1

7.12 Feeder pump operation

In system Anl 3.0, the feeder pump UP1 only starts to operate in the default setting when a flow temperature demand of a secondary controller exists.

If CO7 -> F14 - 1 is configured in the primary controller in addition to CO7 -> F15 - 1, the function is also active when the controller's own secondary circuit requires heat.

Function	WE	Configuration
Send maximum flow set point	0	CO7 -> F14 - 1
	5	Register no. / 5 to 64

7.13 Locking manual level

To protect the heating system, this function can be used to lock manual level. When this function has been activated, automatic mode is started when the rotary switch is set to \uparrow .

Function	WE	Configuration
Locking manual levels	0	CO5 -> F21 - 1

7.14 Locking the rotary switches

When this function has been activated, the controller remains in automatic mode regardless of the rotary switch positions. The rotary switches can no longer be used to adjust the controller settings.

Function	WE	Configuration
Locking the rotary switches	0	CO5 -> F22 - 1

7.15 Setting a customized key number

To avoid that unauthorized personnel modify functions and parameters of the controller, the default key number can be replaced with an individual key number. Choose your custom key number between 0100 and 1900.

Proceed as follows:

- ⇨ Switch to configuration and parameter level. Display shows: **0 0 0 0**
- ⌚ Set key number 1995.
- * Confirm key number.
- ⌚ Set valid key number.
- * Confirm key number. Key number blinks.
- ⌚ Set desired custom key number.
- * Confirm custom key number.
This new key number is now valid.

8 Operational faults

Malfunctions or faults are indicated by the blinking ! icon on the display. The "Error" alarm is displayed immediately. Press the rotary pushbutton to open the error level. It may be possible to view several error alarms by turning the rotary pushbutton. As long as an error is present, error level is displayed, even though it has not been opened by pressing the rotary pushbutton. In addition, the display is illuminated for 1 second in intervals of 10 seconds when a fault persists.

In error level, the error is displayed as specified in the list below.

Note!

After the system code number has been changed, any error alarms are suppressed for approx. 3 minutes.

8.1 Error list

- ▶ Err 1 = Sensor failure (→ section 8.2)
- ▶ Err 2 = Reset to default setting (→ section 2.5)
- ▶ Err 3 = Disinfection temperature not reached (→ section 6.9)
- ▶ Err 4 = Max. charging temperature reached (→ section 6.2)
- ▶ Err 5 = Error alarms issued by the device bus displayed (→ section 7.11.6)
- ▶ Err 6 = Temperature monitoring alarm (→ section 8.3)

8.2 Sensor failure

According to the error list, sensor failures are indicated by displaying "Err 1" in error level. For detailed information, exit error level and view the different temperature values in operating level: each sensor icon displayed together with 3 horizontal lines instead of the measured value indicates a defective sensor. The following list explains how the controller responds to the failure of the different sensors.

- ▶ **Outdoor sensors AF1:** When the outdoor sensor fails, the controller adjusts a flow temperature set point of 50 °C or the *Max. flow temperature* when the *Max. flow temperature* (adjusted under PA1, 2) is smaller than 50 °C.
- ▶ **Flow sensor(s) heating circuit(s):** When the flow sensors in the heating circuits are defective, the associated valve moves to 30 % travel. DHW heating using such a sensor to measure the charging temperature is suspended.
- ▶ **Flow sensors in the DHW circuit with control valve:** When the flow sensor VF4 fails, the controller behaves as if VF4 had not been configured. As soon as the control of the charging temperature becomes impossible (VF2 defective), the associated valve is closed.

- ▶ **Return flow sensors RfF 1/2:** When the return flow sensor fails, the controller continues operation without return flow temperature limitation.
- ▶ **Room sensors RF1/2:** When the room sensor fails, the controller uses the settings for operation without room sensor. The controller, for example, switches from optimizing mode to reduced operation; adaptation mode is canceled. The last determined heating characteristic remains unchanged.
- ▶ **Storage sensors SF 1/2:** When one of the two sensors fails, the storage tank is no longer charged (exception: solar system).
- ▶ **Solar sensors SF 3, VF 3:** When one of the two sensors fails, the storage tank in the solar circuit is no longer charged.

8.3 Temperature monitoring

When a system deviation greater than 10 °C persists in a control loop for 30 minutes, an error alarm "Err 6" (temperature monitoring alarm) is generated.

Function	WE	Configuration
Temperature monitoring	0	CO5 -> F19 - 1

9 Memory module

The use of a memory module (accessory no. 1400-7142) is particularly useful to transfer all data from one TROVIS 5575 Controller to several other TROVIS 5575 Controllers. The memory module is plugged into the RJ45 connector integrated into the front panel. Once the module has been connected, "75 SP" is displayed. If the memory module already contains data from a different TROVIS 5576 Controller, turn the rotary pushbutton until "SP 75" is displayed

- ▶ Pressing the rotary pushbutton to confirm "75 SP" causes the controller settings to be transferred to the memory module.
- ▶ Pressing the rotary pushbutton to confirm "SP 75" causes the saved controller settings to be transferred from the memory module to the controller.

During the data transfer, the bars on the display indicate the progress. When the transfer was successful, "I.O." is displayed. After that, the connection between controller and memory module can be terminated.

A database module for TROVIS 5575 Controller to integrate into the PC user interface, TROVIS-VIEW 6661, is planned. Using TROVIS-VIEW, it is possible to adjust all controller settings in a convenient user interface on the PC and transfer them to a connected memory module. In addition, data can be read from a memory module to change or print them.

10 Installation

The controller consists of the housing with the electronics and the back panel with the terminals. It is suitable for panel, wall and top hat rail mounting (Fig. 11).

Panel mounting

1. Remove both screws (1).
2. Pull apart the controller housing and the back panel.
3. Make a cut-out of 138 x 92 mm (W x H) in the control panel.
4. Insert the controller housing through the panel cut-out.
5. Insert one mounting clamp (2) each at the top and bottom or at the side. Screw the threaded rod towards the panel with a screwdriver so that the housing is clamped against the control panel.
6. Install the electrical connections at the back of the housing as described in section 11.
7. Fit the controller housing.
8. Fasten both screws (1).

Wall mounting

1. Remove both screws (1).
2. Pull apart the controller housing and the back panel.
3. If necessary, bore holes with the specified dimensions in the appropriate places.
Fasten the back panel with four screws.
4. Install the electrical connections at the back of the housing as described in section 11.
5. Remount the controller housing.
6. Fasten both screws (1).

Top hat rail mounting

1. Fasten the spring-loaded hook (4) at the bottom of the top hat rail (3).
2. Slightly push the controller upwards and pull the upper hook (5) over the top hat rail.

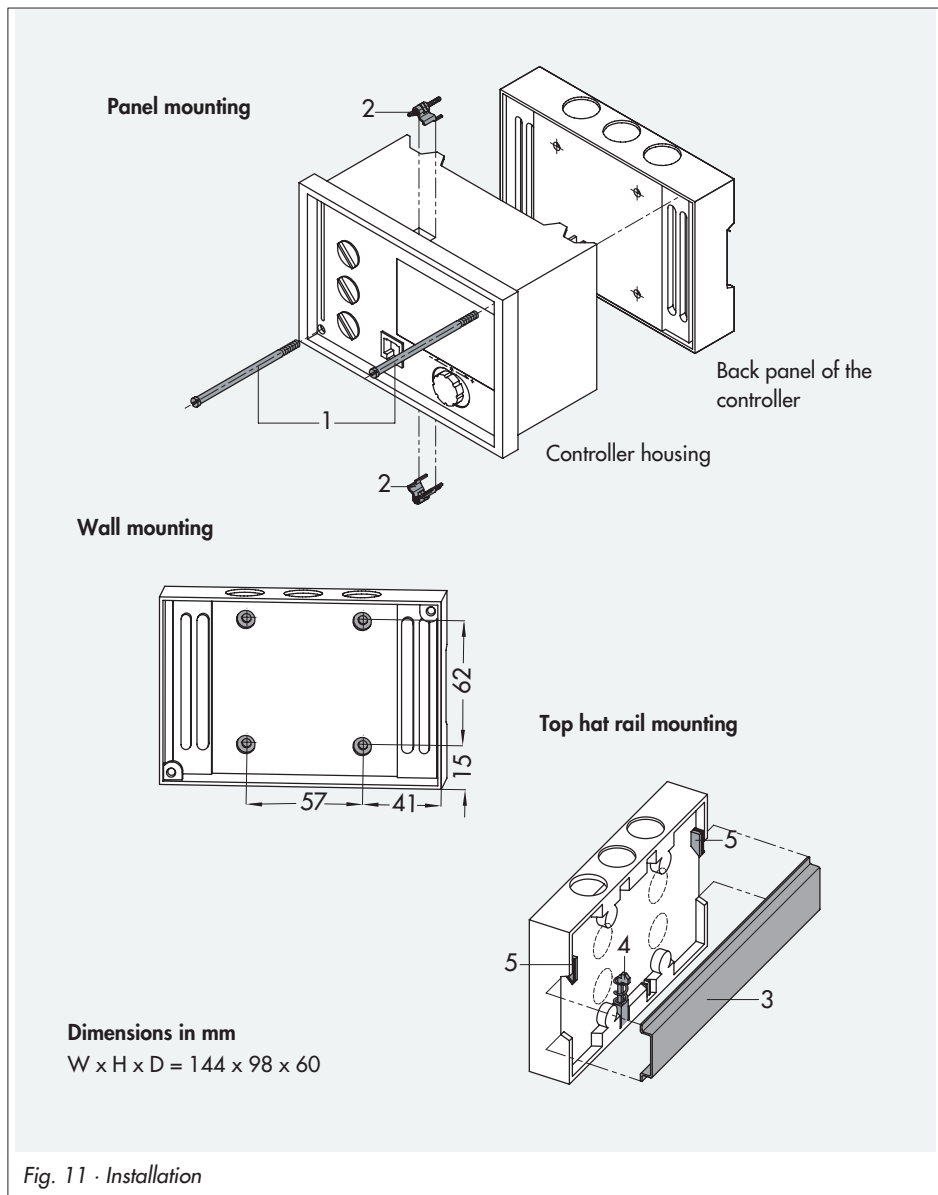

Fig. 11 · Installation

11 Electrical connection

Caution!

For electrical installation, you are required to observe the relevant electrotechnical regulations of the country of use as well as the regulations of the local power suppliers. Make sure all electrical connections are installed by trained and experienced personnel!

Notes on installing the electrical connections

- ▶ Install the 230 V power supply lines and the signal lines separately! To increase noise immunity, observe a minimum distance of 10 cm between the lines. Make sure the minimum distance is also observed when the lines are installed in a cabinet.
- ▶ The lines for digital signals (bus lines) and analog signals (sensor lines, analog outputs) must also be installed separately!
- ▶ In plants with a high electromagnetic noise level, we recommend to use shielded cables for the analog signal lines. Ground the shield at one side, either at the control cabinet inlet or outlet, using the largest possible cross-section. Connect the central grounding point and the PE grounding conductor with a cable $\geq 10 \text{ mm}^2$ using the shortest route.
- ▶ Inductances in the control cabinet, e.g. contactor coils, are to be equipped with suitable interference suppressors (RC elements).
- ▶ Control cabinet elements with high field strength, e.g. transformers or frequency converters, should be shielded with separators providing a good ground connection.

Overvoltage protection

- ▶ If signal lines are installed outside buildings or over large distances, make sure appropriate surge or overvoltage protection measures are taken. Such measures are indispensable for bus lines!
- ▶ The shield of signal lines installed outside buildings must have current conducting capacity and must be grounded on both sides.
- ▶ Surge diverters must be installed at the control cabinet inlet.

Connecting the controller

The controller is connected as illustrated in the diagram on the page 88.

Open the housing to connect the cables. To connect the feeding cables, make holes in the marked locations at the top, bottom or back of the rear part of the housing and fit suitable grommets or cable glands.

Connecting the sensors

Cables with a minimum cross-section of $2 \times 0.5 \text{ mm}^2$ can be connected to the terminals at the back panel of the housing.

Connecting the actuators

- ▶ Three-step or on/off outputs:
Connect cables with at least 1.5 mm^2 suitable for damp locations to the terminals of the controller output. The direction of travel needs to be checked at start-up.

Note!

Electric actuators are not automatically supplied with a voltage by the controller. They can be connected to an external voltage source over the terminals 25 or 28.

If this is not required, place a jumper from terminal 18 to terminal 25 and 28.

Connecting the pumps

Connect all cables with at least 1.5 mm^2 to the terminals of the controller as illustrated in the connection diagram.

Legend for connection diagram:

AF	Outdoor sensor	BE	Binary input
FG	Potentiometer	BA	Binary output
RF	Room sensor	Rk	Control loop
RüF	Return flow sensor	UP	Circulation pump
SF	Storage tank ensor	SLP	Storage tank charging pump
VF	Flow sensor	WMZ	Heat meter

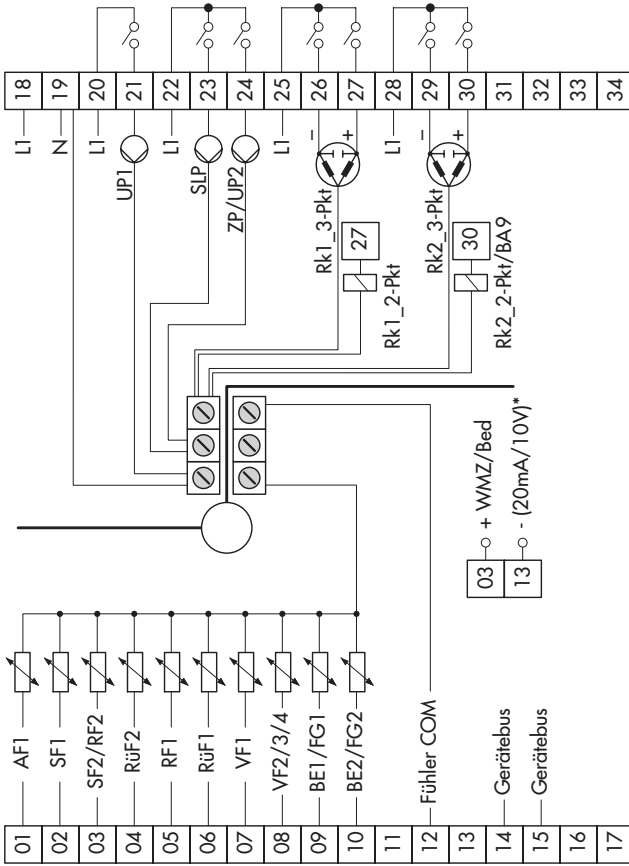

Caution!

Never connect terminal 12 (grounding of sensor) and terminal 13 (grounding of 0 bis 10 V/0 to 20 mA)!

* To apply a 20 mA signal, a 50 Ω resistor is required between terminals 03 and 13!

Fig. 12 · Wiring diagram

12 Appendix

12.1 Function block lists

CO1: Heating circuit 1 (Systems Anl 1.0 to 1.3, 2.x, 4.x, 10.0 and 11.x)
Primary exchanger control (Systems Anl 1.5, 1.6, and 3.0)

F	Function	WE	Anl	Comments Function block parameters/Range of values (default setting)
01	Room sensor RF1	0	Not in Anl 1.5, 1.6, 3.0	CO1 -> F01 - 1: Temperature display and input FG1 for Type 5244/5257-5 Room Panel active TROVIS 5570 Room Panel: CO1 -> F01 - 1 and CO7 -> F03 - 1
02	Outdoor sensor AF1	0	1.5, 1.6	CO1 -> F02 - 1: Weather-compensated control active
		1	Not in Anl 1.5, 1.6	Outdoor temperature received over device bus: CO1 -> F02 - 1 and CO7 -> F07 - 1
03	Return flow sensor RÜF1	0	1.2	CO1 -> F03 - 1: Sensor and limiting function active
		1	Not in Anl 1.2	Function block parameter: Limiting factor / 0.1 to 10.0 (1.0)
04	Reserved			
05	Underfloor heating Drying of jointless floors	0	Not in Anl 1.5, 1.6, 3.0	CO1 -> F05 - 1: Limitation of the adjustment ranges Function block parameters: Temperature rise / 1 to 10 °C/24 h (5 °C/24 h) Maximum temperature / 25 to 60 °C (45 °C) Maintaining time of max. temperature / 1 to 10 days (1 day) Temperature reduction / 0 to 10 °C/ 24 h (0 °C / 24 h) START
06	Reserved			
07	Optimization	0	Not in Anl 1.5, 1.6, 3.0	CO1 -> F07 - 1: Only with <ul style="list-style-type: none"> • CO1 -> F01 - 1 • CO1 -> F02 - 1
08	Adaptation	0	Not in Anl 1.5, 1.6, 3.0	CO1 -> F08 - 1: Only with <ul style="list-style-type: none"> • CO1 -> F01 - 1 • CO1 -> F02 - 1 • CO1 -> F11 - 0
09	Flash adaptation	0	Not in Anl 1.5, 1.6, 3.0	CO1 -> F09 - 1 Only with CO1 -> F01 - 1 Function block parameter: Cycle time / 1 to 100 min (20 min)
10	Reserved			

			Comments	
F	Function	WE	Anl	Function block parameters/Range of values (default setting)
11	4-point characteristic	0	Not in Anl 1.5, 1.6, 3.0	CO1 -> F11 - 1: 4-point characteristic, only with CO1 -> F08 - 0 CO1 -> F11 - 0: Gradient characteristic
12	Control type three-step	1	All	CO1 -> F12 - 1: Three-step control Function block parameters: K _p (proportional gain) / 0.1 to 50.0 (2.0) T _N (reset time) / 1 to 999 s (120 s) T _v (transit time) / 15, 30, ..., 240 s (45 s) CO1 -> F12 - 0: On/off control; OPEN/CLOSE signal issued for valve, i.e. L1 is switched between terminal 26 and 27. Function block parameters: Hysteresis / 1 to 30 °C (5 °C) Min. ON time / 0 to 10 min (2 min) Min. OFF time / 0 to 10 min (2 min)
13	Limitation of deviation for OPEN signal	0	All	CO1 -> F13 - 1 only with CO1 -> F12 - 1 Function block parameter: Max. system deviation / 2 to 10 °C (2 °C)
14	Release Rk1 at BE1	0	All	With CO1 -> F14 - 1 is FG1 without function Select bE / 1, 0 (1)
15	Processing of external demand in Rk1	0	All	How the external demand is processed in Rk1 depends on CO1 -> F16, CO1 -> F17 and CO7 -> F15.
16	Processing of external demand 0 to 10 V Input term. 03/13	0	Not in systems with SF2/RF2	CO1 -> F16 - 1: Only with <ul style="list-style-type: none"> • CO1 -> F15 - 1 • CO1 -> F17 - 0 • CO7 -> F15 - 0
17	Processing of external demand, binary Input term. 03/12	0	Not in systems with SF2/RF2	CO1 -> F17 - 1: Only with <ul style="list-style-type: none"> • CO1 -> F15 - 1 • CO1 -> F16 - 0 • CO7 -> F15 - 0 Select bE / 1, 0 (1)

F Function block number, WE Default setting, Anl System code number

CO₂: Heating circuit 2 (System Anl 10.0)

Supplementary heating circuit (Systems Anl 3.0 and 4.x)

F	Function	WE	Anl	Comments Function block parameters/Range of values (default setting)
01	Room sensor RF2	0	3.0, 4.x, 10.0	CO ₂ -> F01 - 1: Temperature display and input FG2 for Type 5244/5257-5 Room Panel active TROVIS 5570 Room Panel: CO ₂ -> F01 - 1 and CO ₇ -> F04 - 1
02	Outdoor sensor AF2	0	10.0	Without measured value AF2, the value AF1 is read Measured value AF2 only over device bus: CO ₂ -> F02 - 1 and CO ₇ -> F09 - 1
03	Return flow sensor RüF2	1	10.0	CO ₂ -> F03 - 1: Sensor and limiting function active
		0	3.0, 4.x	Function block parameter: Limiting factor / 0.1 to 10.0 (1.0)
04	Reserved			
05	Underfloor heating Drying of jointless floors	0	3.0, 4.x, 10.0	CO ₁ -> F05 - 1: Limitation of the adjustment ranges Function block parameters: Temperature rise / 1 to 10 °C/24 h (5 °C/24 h) Maximum temperature / 25 to 60 °C (45 °C) Maintaining time of max. temperature/1 to 10 days (4 days) Temperature reduction / 0 to 10 °C/ 24 h (0 °C / 24 h) START
06	Reserved			
07	Optimization	0	10.0	CO ₂ -> F07 - 1: Only with <ul style="list-style-type: none"> • CO₂ -> F01 - 1 • CO₁ -> F02 - 1
08	Adaptation	0	3.0, 4.x, 10.0	CO ₂ -> F08 - 1: Only with <ul style="list-style-type: none"> • CO₂ -> F01 - 1 • CO₁ -> F02 - 1 • CO₂ -> F11 - 0
09	Flash adaptation	0	3.0, 4.x, 10.0	CO ₂ -> F09 - 1: Only with CO ₂ -> F01 - 1 Function block parameter: Cycle time / 1 to 100 min (20 min)
10	Reserved			
11	4-point characteristic	0	3.0, 4.x, 10.0	CO ₂ -> F11 - 1: 4-point characteristic, only with CO ₂ -> F08 - 0 CO ₂ -> F11 - 0: Gradient characteristic

				Comments
F	Function	WE	AnI	Function block parameters/Range of values (default setting)
12	Control type three-step	1	3.0, 4.x, 10.0	CO2 -> F12 - 1: Three-step control Function block parameters: K _p (proportional gain) / 0.1 to 50.0 (2.0) T _N (reset time) / 1 to 999 s (120 s) T _v (transit time) / 15, 30, ..., 240 s (45 s) CO2 -> F12 - 0 (only in system AnI 10.0): On/off control; OPEN/CLOSE signal issued for valve, i.e. L1 is switched between terminal 29 and 30 Function block parameters: Hysteresis / 1 to 30 °C (5 °C) Min. ON time / 0 to 10 min (2 min) Min. OFF time / 0 to 10 min (2 min)
13	Limitation of deviation for OPEN signal	0	3.0, 4.x, 10.0	CO2 -> F13 - 1 only with CO2 -> F12 - 1 Function block parameter: Max. system deviation / 2 to 10 °C (2 °C)
14	Release Rk2 at BE2	0	3.0, 4.x, 10.0	With CO2 -> F14 - 1 is FG1 without function Select bE / 1, 0 (1)

F Function block number, WE Default setting, AnI System code number

CO4: DHW circuit (Systems Anl 1.1–1.3, 1.5, 1.6, 4.1, 4.5, 11.x)*

F	Function	WE	Anl	Comments Function block parameters/Range of values (default setting)
01	Storage tank sensor SF1	1	All*	CO4 -> F01 - 0 (not Anl 11.0): Storage tank thermostat, only with CO4 -> F02 - 0
02	Storage tank sensor SF2 with the function of stopping the storage tank charging (not assigned to solar circuit)	0	1.1, 1.3, 1.5, 2.0, 2.1, 2.3, 4.1, 4.5, 11.0, 11.1	CO4 -> F02 - 1 (not in Anl 1.3, 2.3 and 11.0): only with CO4 -> F01 - 1
		1	1.2, 1.6, 2.2, 11.2	
03	Return flow sensor RÜF2	0	11.x	CO4 -> F03 - 1: Sensor and limiting function active; Function block parameter: Limiting factor / 0.1 to 10.0 (1.0)
04	Reserved			
05	Flow sensor VF4	0	1.1, 1.2, 1.6, 2.2, 11.2	CO4 -> F05 - 1: Flow sensor VF4 for measuring storage tank charging temperature active
06	Parallel pump operation	0	2.1–2.3, 4.1, 4.5	CO4 -> F06 - 1: Function block parameters: Stop parallel pump operation in case of deviation / 2 to 10 min (10 min) Flow limit temp. parallel pump operation / 20 to 90 °C (40 °C) CO4 -> F06 - 0: UP1 switched off during DHW heating
07	Intermediate heating	1	2.x, 4.1, 4.5	CO4 -> F07 - 1: After 20 minutes of DHW heating, heating operation in UP1 circuit reactivated for 10 minutes CO4 -> F07 - 0: Storage tank charging is given unlimited priority over heating operation in UP1 circuit
08	Priority through reverse control	0	1.1–1.3, 4.1, 4.5, 11.x	CO4 -> F08 - 1 Only with CO4 -> F09 - 0 Function block parameters: Activate priority in case of deviation / 2 to 10 min (2 min) Correction factor / 0.1 to 10.0 (1.0)
09	Priority through set-back operation	0	1.1–1.3, 4.1, 4.5, 11.x	CO4 -> F09 - 1 only with CO4 -> F08 - 0 Function block parameter: Activate priority in case of deviation / 2 to 10 min (2 min)

F	Function	WE	Anl	Comments Function block parameters/Range of values (default setting)
10	Circulation pump integrated into heat exchanger	0	1.6, 11.2	CO4 -> F10 - 1: Control of DHW circuit active while circulation pump ZP is operated
11	Operation of circulation pump during storage tank charging	0	All*	CO4 -> F11 - 1: Circulation pump (ZP) operates according to schedule during storage tank charging CO4 -> F11 - 0: ZP switched off during storage tank charging Circulation pump = ZP
12	Control type three-step	1	11.x	CO4 -> F12 - 1: Three-step control Function block parameters: K _p (proportional gain) / 0.1 to 50.0 (2.0) T _N (reset time) / 1 to 999 s (120 s) T _v (transit time) / 15, 30, ..., 240 s (45 s) CO4 -> F12 - 0 (only in systems Anl 11.0, 11.1): On/off control; OPEN/CLOSED signal for valve issued, i.e. L1 is switched between terminals 29 and 30 Function block parameters: Hysteresis / 1 to 30 °C (5 °C) Min. ON time / 0 to 10 min (2 min) Min. OFF time / 0 to 10 min (2 min)
13	Limit deviation for OPEN signal	0	11.x	CO4 -> F13 - 1 only with CO4 -> F12 - 1 Function block parameter: Max. deviation / 2 to 10 °C (2 °C)
14	Thermal disinfection	0	All*	CO4 -> F14 - 1 only with CO4 -> F01 - 1 Function block parameters: Day of the week / 1, 2, ..., 7, 1-7 (3) Start time / 00:00 h to 23:45 h (00:00) Stop time / 00:00 h to 23:45 h (04:00) Disinfection temperature / 60 to 90 °C (70 °C) Setting Start time = Stop time Option: bE / 1.0 (1), Input terminal 03/12 (only possible without SF2/RF2)
15	SLP ON depending on return flow temperature	0	1.5, 1.6, 2.1, 2.3, 4.1	CO4 -> F15 - 1 only with CO1 -> F03 - 1
16	Priority for external demand	0	1.5, 1.6, 2.x, 4.1	With CO4 -> F16 - 1, a high external demand causes excessive charging temperatures in DHW circuits without control valve

F Function		WE	Anl	Comments Function block parameters/Range of values (default setting)
19	Time-controlled switchover of storage tank sensors	0	Not Anl 11.0	CO4 -> F19 - 1 only with CO4 -> F02 - 1 SF1 for day mode and SF2 for night mode.
20	DHW circuit additionally controlled by a globe valve	0	11.1	CO4 -> F20 - 1: Return flow temperature limitation over a globe valve with VF2 in the heating register return of the storage tank.

F Function block number, WE Default setting, Anl System code number

CO5: System-wide functions (all systems)

If CO5 -> F00 - 1 is indicated, access to the return flow, flow rate and heat capacity settings are locked.

F	Function	WE	Anl	Comments Function block parameters/Range of values (default setting)
01	Sensor initialization	1	All	CO5 -> F01 - 1 and CO5 -> F02 - 0: Pt 1000 (Pt 100)
02		0	All	CO5 -> F01 - 0 and CO5 -> F02 - 0: PTC (Pt 100), CO5 -> F01 - 1 and CO5 -> F02 - 1: NTC (Pt 100) CO5 -> F01 - 1 and CO5 -> F02 - 1: Ni 1000 (Pt 100)
03	Reserved			
04	Summer mode	0	All	CO5 -> F04 - 1: Activation of time-controlled summer mode; Function block parameters: Start summer mode / 01.01 to 31.12 (01.06) No. of days until activation / 1 to 3 (2) Stop summer mode / 01.01 to 31.12 (30.09) No. of days until deactivation / 1 to 3 (1) OT limit value summer mode / 0 to 30 °C (18 °C)
05	Delayed OT adaptation when OT decreases	0	All	CO5 -> F05, 06 - 1: Function block parameter: Delay / 1 to 6 °C/h (3 °C/h)
06	Delayed OT adaptation when OT increases	0	All	
07	Reserved			
08	Automatic summer time/winter time changeover	1	All	
09	Frost protection program II	1	Not in Anl 1.5, 1.6	CO5 -> F09 - 0: Frost protection program I (restricted frost protection)
		0	1.5, 1.6	Function block parameters: Frost protection limit / -15 to 3 °C (3 °C) CO5 -> F09 - 1: Frost protection program II
10	Flow rate limitation (capacity limitation) in Rk1 with pulses at input WMZ	0	Not in Anl 10.0; not in systems with SF2/RF2	CO5 -> F10 - 1 only with CO5 -> F11 - 0 Input "WMZ/Bed" (terminals 03/13) Function block parameters: Max. limit value / 3 to 500 $\frac{\text{imp}}{\text{h}}$ (15 $\frac{\text{imp}}{\text{h}}$) Max. limit value heating* / 3 to 500 $\frac{\text{imp}}{\text{h}}$ (15 $\frac{\text{imp}}{\text{h}}$) Max. limit value DHW* / 3 to 500 $\frac{\text{imp}}{\text{h}}$ (15 $\frac{\text{imp}}{\text{h}}$) Limiting factor / 0.1 to 10.0 (1.0)

				Comments
F	Function	WE	Anl	Function block parameters/Range of values (default setting)
11	Flow rate limitation in Rk1 with 0/4 to 20 mA at input WMZ (with 50 Ω in parallel to input WMZ terminal 03/13)	0	Not in Anl 10.0; not in systems with SF2/RF2	CO5 -> F11 - 1 only with CO5 -> F10 - 0 Input "WMZ/Bed" (terminal 03/13) Function block parameters: Lower measuring range value 0 or 4 mA Upper meas. range value 20 mA / 0.01 to 650 m ³ /h (1.5 m ³ /h) Max. limit value/ 0.01 to 650 m ³ /h (1.5 m ³ /h) Max. limit value heating* / 0.01 to 650 m ³ /h (1.5 m ³ /h) Max. limit value DHW* / 0.01 to 650 m ³ /h (1.5 m ³ /h) Limiting factor / 0.1 to 10.0 (1.0)
12	Creep feed rate limitation	0	All	CO5 -> F12 - 1: Creep feed rate limitation, input terminal 04/12 Function block parameter: bE / 1, 0 (1)
16	Return flow temperature limitation with P algorithm	0	All	CO5 -> F16 - 1: Return flow temperature limitation with P-action only
19	Temperature monitoring	0	All	CO5 -> F19 - 1: Temperature monitoring active
20	Sensor calibration	1	All	CO5 -> F20 - 1: Adjusting all sensor calibration values CO5 -> F20 - 0: Deleting all sensor calibration values
21	Locking manual level	0	All	CO5 -> F21 - 1: In switch position  , automatic mode is applied
22	Locking the rotary switches	0	All	CO5 -> F22 - 1: All rotary switches are locked
23	Test mode	0	All	Only for internal use!
				*Not in systems Anl 1.0, 1.5, 1.6, 3.0, 4.0, 11.x

F Function block number, WE Default setting, Anl System code number

CO7: Device bus (all systems; F02, F03, ... only with CO7 -> F01 -1)

F	Function	WE	Anl	Comment Function block parameters/Range of values (default setting)
01	bDevice bus	0	All	CO7 -> F01 - 1: Device bus active Function block parameter: Device bus address /Auto*, 1 to 32 (32) *Auto = controller automatically searches for free device bus address in the system
02	Clock synchronization	0	All	CO7 -> F02 - 1: Controller sends its system time to all units connected to the device bus every 24 hours
03	TROVIS 5570 Room Panel in Rk1	0	1.0–1.3, 2.x, 4.x, 10.0, 11.x	CO7 -> F03 - 1: Communication with TROVIS 5570 active for Rk1; CO1 -> F01 - 1 is set automatically Function block parameter: Device bus address / Auto*, 1 to 32 (32) *Auto = controller automatically searches for a room panel for which detection mode has been activated
04	TROVIS 5570 Room Panel in Rk2	0	3.0, 4.x, 10.0	CO2 -> F01 - 1: Communication with TROVIS 5570 active for Rk2; CO2 -> F01 - 1 is set automatically Function block parameter: Device bus address / Auto*, 1 to 32 (32) *Auto = controller automatically searches for a room panel for which detection mode has been activated
05	Reserved			
06	Send value AF1	0	All	Function block parameter: Register no. / 1 to 4 (1)
07	Receive value AF1	0	All	Function block parameter: Register no. / 1 to 4 (1)
08	Reserved			
09	Receive value AF2	0	All	Function block parameter: Register no. / 1 to 4 (2)
10	Send flow set point Rk1	0	All	CO7 -> F10 - 1: In systems Anl 1.5, 1.6, 2.x, 3.0, 4.0, 4.1, the storage tank charging set point is sent during DHW heating Function block parameter: Register no. / 5 to 64 (5)
11	Send flow set point Rk2	0	All	Function block parameter: Register no. / 5 to 64 (5)
12	Reserved			

F	Function	WE	Anl	Comment Function block parameters/Range of values (default setting)
13	Send flow set point DHW	0	All	CO7 -> F13 - 1: In level PA4, the <i>Charging temperature boost</i> parameter is generated Function block parameter: Register no. / 5 to 64 (5)
14	Send maximum flow set point	0	All	CO7 -> F14 - 1: Internally, the controller already determines the max. flow set point of its circuits and sends this value to the primary controller; Function block parameter: Register no. / 5 to 64 (5)
15	Receive external demand	0	All	CO7 -> F15 - 1: External processing of external demand in Rk1 using device bus; Function block parameter: Register no. / 5 to 64 (5)
16	Reserved			
17	Send all temperature values		All	Not relevant for connection of several controllers
18	Send switching states of binary outputs	0	All	Not relevant for connection of several controllers
19	Send control signals	0	All	Not relevant for connection of several controllers
20	Send "DHW heating active"	0	All	CO7 -> F20 - 1: Function block parameters: Register value for active DHW heating / 0, 1 (0) Register no. / 5 to 64 (32)
21	Receive release of Rk1	0	All	CO7 -> F21 - 1: Function block parameter: Register no. / 5 to 64 (32)
22	Receive release of Rk2	0	All	CO7 -> F22 - 1: Function block parameter: Register no. / 5 to 64 (32)

F Function block number, WE Default setting, Anl System code number

12.2 Parameter lists

PA1 (☐): Parameter level Heating circuit 1 (Systems Anl 1.0 to 1.3, 2.x, 4.x, 10.0 and 11.x)

Primary exchanger control (Systems Anl 1.5, 1.6 and 3.0)

PA2 (☐): Parameter level Heating circuit 2 (System Anl 10.0)

Supplementary heating circuit (Systems Anl 3.0 and 4.x)

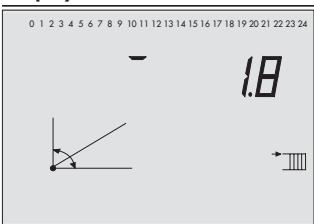
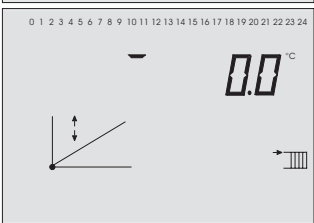
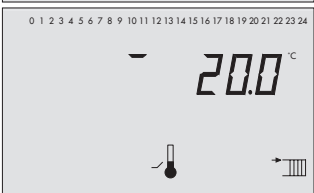
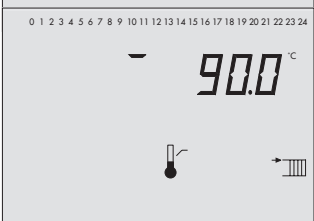
Display	Parameter designation Range of values (default setting)
	<p>Gradient, flow</p> <p>0.2 to 3.2 (1.8) (with CO1, 2 -> F05 - 1: 0.2 to 1.0 (1.0) applies)</p>
	<p>Level (parallel shift)</p> <p>-30 to 30 °C (0 °C)</p>
	<p>Min. flow temperature</p> <p>5 to 130 °C (20 °C)</p>
	<p>Max. flow temperature</p> <p>5 to 130 °C (90 °C) (with CO1, 2 -> F05 - 1: 5 to 50 °C (50 °C) applies)</p>

Display

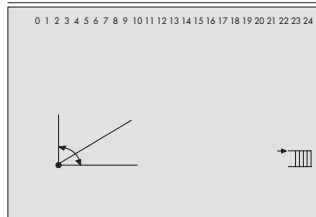

4-point characteristic

- * Press rotary pushbutton to adjust the parameters outdoor temperature, flow temperature, reduced flow temperature and return flow temperature.

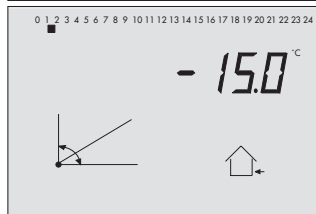

4-point characteristic

Point 1: Outdoor temperature

Outdoor temperatures of the points 2, 3, 4 are marked by squares below the numbers 2, 3, 4.

-30 to 50 °C

(point 1: -15 °C, point 2: -5 °C, point 3: 5 °C, point 4: 15 °C)

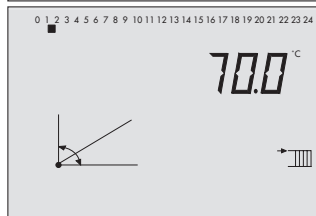

4-point characteristic

Point 1: Flow temperature

Flow temperatures of the points 2, 3, 4 are marked by squares below the numbers 2, 3, 4.

5 to 130 °C

(point 1: 70 °C, point 2: 55 °C, point 3: 40 °C, point 4: 25 °C)

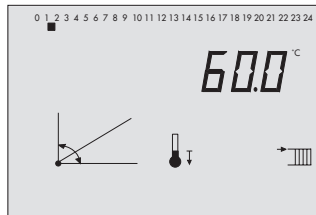

4-point characteristic

Point 1: Reduced flow temperature

Reduced flow temperatures of the points 2, 3, 4 are marked by squares below the numbers 2, 3, 4.

5 to 130 °C

(point 1: 60 °C, point 2: 40 °C, point 3: 20 °C, point 4: 20 °C)

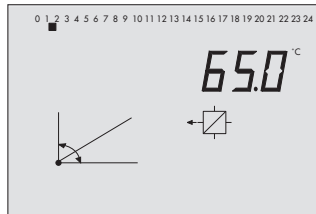

4-point characteristic

Point 1: Return flow temperature

Return flow temperatures of the points 2, 3, 4 are marked by squares below the numbers 2, 3, 4.

5 to 90 °C

(points 1 to 4: 65 °C)

Display

Parameter designation

Range of values (default setting)



OT deactivation value rated operation

0 to 50 °C (22 °C)

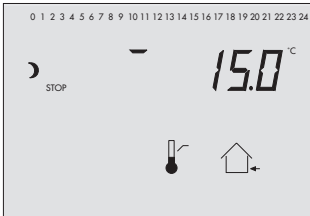

OT deactivation value in reduced operation

-20 to 50 °C (15 °C)

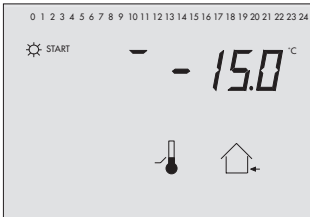

OT activation value in rated operation

-20 to 5 °C (-15 °C)

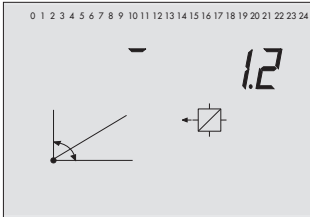

Gradient, return flow

0.2 to 3.2 (1.2)

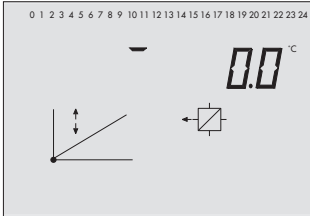

Level, return flow

-30 to 30 °C (0 °C)

Display

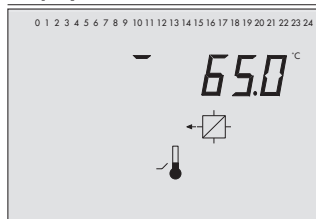

Return flow temperature foot

5 to 90 °C (65 °C)

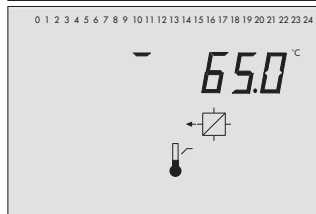

Max. return flow temperature

5 to 90 °C (65 °C)

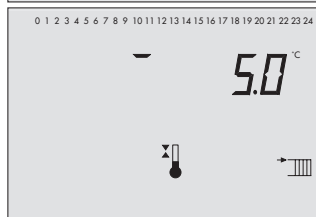

Set point boost for primary exchanger control

0 to 50 °C (5 °C)

Only in parameter level PA1

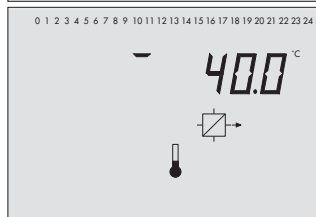

Set point for binary demand processing

5 to 130 °C (40 °C)

Only in parameter level PA1

PA4: Parameters DHW heating

(Systems An1 1.1 to 1.3, 1.5, 1.6, 2.x, 4.1, 4.5 and 11.x)

Display

Parameter designation

Range of values (default setting)



Min. DHW temperature

20 to 90 °C (40 °C)

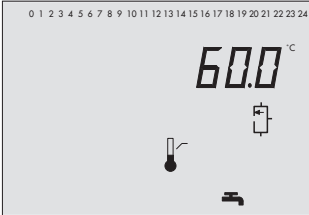

Max. DHW temperature

20 to 90 °C (60 °C)

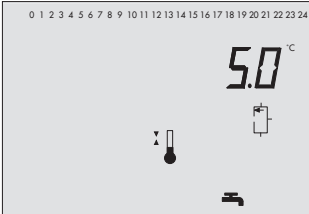

Hysteresis

0 to 30 °C (5 °C)

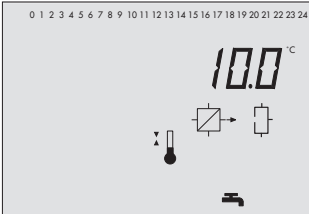

Charging temperature boost

0 to 50 °C (10 °C)

Display

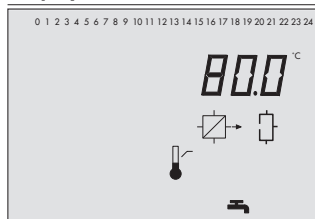

Max. charging temperature

20 to 130 °C (80 °C)

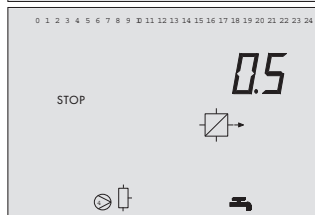

Lag of storage tank charging pump

0.1 to 10.0 (0.5)

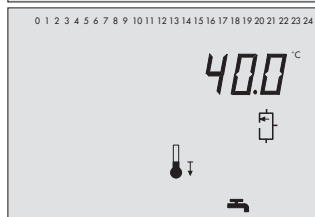

Sustained DHW temperature

20 to 90 °C (40 °C)

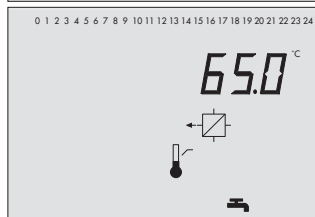

Max. return flow temperature

20 to 90 °C (65 °C)

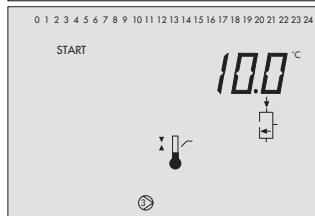

Solar pump ON

1 to 30 °C (10 °C)

Display

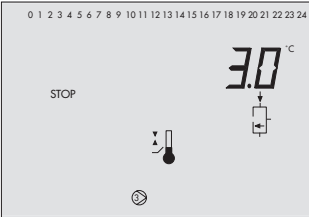

Parameter designation

Range of values (default setting)

Solar pump OFF

0 to 30 °C (3 °C)

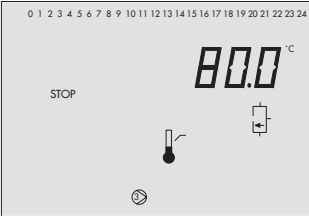

Max. storage tank temperature

20 to 90 °C (80 °C)

PA5: Parameters for several systems (all systems)

Display

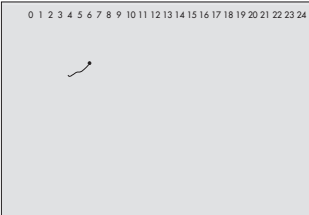

Parameter designation

Range of values (default setting)

Public holidays

01.01 to 31.12 (-> section 1.8.1)

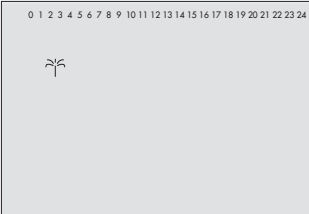

Vacation periods

01.01 to 31.12 (-> section 1.8.2)

12.3 Assignment of the rotary switches

System Anl	Top rotary switch	Middle rotary switch	Bottom rotary switch
1.0	Heating circuit (Rk1)	–	–
1.1 to 1.3	Heating circuit (Rk1)	–	DHW heating
1.5, 1.6	Primary heat exchanger circuit (Rk1)	–	DHW heating
2.x	Heating circuit (Rk1)	–	DHW heating
3.0	Primary heat exchanger circuit and heating circuit (Rk1, Rk2)	–	–
4.x	Heating circuit (Rk1)	Supplementary heating circuit (Rk2)	DHW heating
10.0	Heating circuit 1 (Rk1)	Heating circuit 2 (Rk2)	–
11.x	Heating circuit (Rk1)	–	DHW heating (Rk2)

12.4 Sensor resistance tables

Resistance values with PTC resistors

Type 5224 Outdoor Temperature Sensors, Type 5264 and Type 5265 Flow and Return Flow Temperature Sensors, Type 5264 Storage Tank Temperature Sensors

°C	-20	-10	0	10	20	25	30	40	50	60	70	80	90	100	110	120
Ω	694	757	825	896	971	1010	1050	1132	1219	1309	1402	1500	1601	1706	1815	1925

Type 5244 Room Panel

Switch position ☐, terminals 1 and 2

°C	10	15	20	25	30
Ω	679	699	720	741	762

Resistance values with Pt 1000 resistors

Type 5227-2 Outdoor Temperature Sensor, Type 5277-2 (thermowell required) and Type 5267-2 (contact sensor) Flow, Return Flow and Storage Tank Temperature Sensors. Type 5257-1, Type 5257-5 (room panel) Room Temperature Sensors.

°C	-35	-30	-25	-20	-15	-10	-5	0	5	10
Ω	862.5	882.2	901.9	921.6	941.2	960.9	980.4	1000.0	1019.5	1039.0
°C	15	20	25	30	35	40	45	50	55	60
Ω	1058.5	1077.9	1097.3	1116.7	1136.1	1155.4	1174.7	1194.0	1213.2	1232.4
°C	65	70	75	80	85	90	95	100	105	110
Ω	1251.6	1270.7	1289.8	1308.9	1328.0	1347.0	1366.0	1385.0	1403.9	1422.9
°C	115	120	125	130	135	140	145	150		
Ω	1441.7	1460.6	1479.4	1498.2	1517.0	1535.8	1554.5	1573.1		

Resistance values with Ni 1000 resistors (acc. to DIN 43760)

°C	-35	-30	-25	-20	-15	-10	-5	0	5	10
Ω	816.2	841.5	867.0	893.0	919.2	945.8	972.7	1000.0	1027.6	1055.5
°C	15	20	25	30	35	40	45	50	55	60
Ω	1083.8	1112.4	1141.3	1170.6	1200.2	1230.1	1260.4	1291.1	1322.0	1353.4
°C	65	70	75	80	85	90	95	100	105	110
Ω	1385.1	1417.2	1449.7	1482.5	1515.7	1549.3	1583.4	1617.8	1652.6	1687.9
°C	115	120	125	130	135	140	145	150		
Ω	1723.6	1759.7	1796.3	1833.3	1870.9	1908.9	1947.4	1986.3		

12.5 Technical data

Inputs	8 inputs for temperature sensor Pt 1000/Pt 100, PTC/Pt 100, NTC/Pt 100 or Ni 1000/Pt 100 and 2 binary inputs, Input terminal 03 alternatively for flow rate signal from heat meters or demand signal from supplementary control circuits, 4(0) to 20 mA with 50 Ω parallel resistor or 0 to 10 V (demand: 0 to 10 V correspond with 20 to 120 °C flow temperature)
Outputs	2 x three-step signal: load max. 250 V AC, 2A alternatively 2 x on/off signal: load max. 250 V AC, 2A 3 x pump output: load max. 250 V AC, 2A; all outputs relay outputs with varistor suppression
Interfaces Device bus	RS-485 interface for max. 32 bus devices, (2-wire connection, polarity independent, connection to terminals 14/15)
Operating voltage	165 to 250 V, 48 to 62 Hz, max. 4 VA
Ambient temperature	0 to 40 °C (operation), -10 °C to 60 °C (storage and transportation)
Degree of protection	IP 40 according to IEC 529
Class of protection	II according to VDE 0106
Degree of contamination	2 according to VDE 0110
Overvoltage category	II according to VDE 0110
Humidity rating	F according to VDE 40040
Noise immunity	According to EN 61000-6-1
Noise emission	According to EN 61000-6-3
Weight	Approx. 0.5 kg

12.6 Customer data

Station	
Operator	
Responsible SAMSON office	
System code number	

Function block settings in the configuration levels

	CO 1	CO 2	CO 4	CO 5	CO 7
F01					
F02					
F03					
F04					
F05					
F06					
F07					
F08					
F09					
F10					
F11					
F12					
F13					
F14					
F15					
F16					
F17					
F18					
F19					
F20					
F21					
F22					
F23					

Parameters in level 1 and level 2 (control circuit 1 and 2)

Parameters (PA1 and PA2)	Level 1	Level 2	Range of values
Gradient, flow			0.2 to 3.2
Level, flow			-30 to 30 °C
Min. flow temperature			5 to 130 °C
Max. flow temperature			5 to 30 °C
4-point characteristic			
Outdoor temperature; Point 1			-30 to 50 °C
Outdoor temperature; Point 2			-30 to 50 °C
Outdoor temperature; Point 3			-30 to 50 °C
Outdoor temperature; Point 4			-30 to 50 °C
Flow temperature; Point 1			5 to 130 °C
Flow temperature; Point 2			5 to 130 °C
Flow temperature; Point 3			5 to 130 °C
Flow temperature; Point 4			5 to 130 °C
Reduced flow temperature; Point 1			5 to 130 °C
Reduced flow temperature; Point 2			5 to 130 °C
Reduced flow temperature; Point 3			5 to 130 °C
Reduced flow temperature; Point 4			5 to 130 °C
Return flow temperature; Point 1			5 to 90 °C
Return flow temperature; Point 2			5 to 90 °C
Return flow temperature; Point 3			5 to 90 °C
Return flow temperature; Point 4			5 to 90 °C
OT deactivation value rated operation			0 to 50 °C
OT deactivation value reduced operation			-20 to 50 °C
OT activation value rated operation			-20 to 50 °C
Gradient, return flow			0.2 to 3.2
Level, return flow			-30 to 30 °C
Return flow temperature foot			5 to 90 °C
Max. return flow temperature			5 to 90 °C
Set point boost f. primary exchanger control			0 to 50 °C
Processing of external demand, binary			5 to 130 °C

Function block parameters (CO1 and CO2)	Level 2	Range of values
Limiting factor (F03 - 1)		0.1 to 10.0
Temperature rise (F05 - 1)		1 to 10 °C/24 h
Maximum temperature (F05 - 1)		25 to 60 °C
Maintaining time of max. temp. (F05 - 1)		1 to 10 days
Temperature reduction (F05 - 1)		0 to 10 °C/24 h
Cycle time (F09 - 1)		1 to 100 min
Proportional gain K_p (F12 - 1)		0.1 to 50
Reset time T_N (F12 - 1)		1 to 999 s
Transit time T_v (F12 - 1)		15 to 240 s
Hysteresis (F12 - 0)		1 to 30 °C
Min. ON time (F12 - 0)		0 to 10 min
Min. OFF time (F12 - 0)		0 to 10 min
Max. deviation (F13 - 1)		2 to 10 °C

Parameters in level 4 (DHW heating)

Parameters (PA4)	Level 4	Range of values
Min. DHW temperature		20 to 90 °C
Max. DHW temperature		20 to 90 °C
Hysteresis		0 to 30 °C
Charging temperature boost		0 to 50 °C
Max. charging temperature		20 to 130 °C
Lag of storage tank charging pump		0.1 to 10.0
Sustained DHW temperature		20 to 90 °C
Max. return flow temperature		0 to 90 °C
Solar pump ON		1 to 30 °C
Solar pump OFF		0 to 30 °C
Max. storage tank temperature		20 to 90 °C

Function block parameters (CO4)		
Limiting factor (F03 - 1)		0.1 to 10.0
Stop parallel operation in case of deviation (F06 - 1)		0 to 10 min
Flow limit temp. f. parallel pump operation (F06 - 1)		20 to 90 °C
Activate priority in case of deviation (F08 - 1)		2 to 10 min
Correction factor (F08 - 1)		0.1 to 10.0
Activate priority in case of deviation (F09 - 1)		2 to 10 min
Proportional gain K_p (F12 - 1)		0.1 to 50
Reset time T_N (F12 - 1)		1 to 999 s
Transit time T_v (F12 - 1)		15 to 240 s
Hysteresis (F12 - 0)		1 to 30 °C
Min. ON time (F12 - 0)		0 to 10 min
Min. OFF time (F12 - 0)		0 to 10 min
Max. system deviation (F13 - 1)		2 to 10 °C
Day of the week (F14 - 1)		1-7, 1 to 7
Start time (F14 - 1)		00:00 to 23:45 h
Stop time (F14 - 1)		00:00 to 23:45 h
Disinfection set point (F14 - 1)		60 to 90 °C

Parameters in level 5

Parameter (PA5)	Level 5					Range of values
Vacation						01.01 to 31.12
Vacation period, Start						01.01 to 31.12
Vacation period, Stop						
Assignment to control circuit						Rk1, Rk2, Rk4
Vacation period, Start						01.01 to 31.12
Vacation period, Stop						
Assignment to control circuit						Rk1, Rk2, Rk4
Function block parameters (CO5)						
Start summer mode (F04 - 1)						01.01 to 31.12
Number of days until activation (F04 - 1)						1 to 3
Stop summer mode (F04 - 1)						01.01 to 31.12
Number of days until deactivation (F04 - 1)						1 to 3
OT limit value (F04 - 1)						0 to 30 °C
Delay (F05/6 - 1)						1 to 6 °C/h
Frost protection limit (F09 - 0)						-15 to 3 °C
Max. limit value (F10 - 1)						3 to 500 $\frac{\text{pulse}}{\text{h}}$
Max. limit value heating (F10 - 1)						3 to 500 $\frac{\text{pulse}}{\text{h}}$
Max. limit value DHW (F10 - 1)						3 to 500 $\frac{\text{pulse}}{\text{h}}$
Limiting factor (F10 - 1)						0.1 to 10.0
Lower measuring range value (F11 - 1)						0/4 mA
Upper measuring range value 20 mA (F11 - 1)						0.01 to 650 $\frac{\text{m}^3}{\text{h}}$
Max. limit value (F11 - 1)						0.01 to 650 $\frac{\text{m}^3}{\text{h}}$
Max. limit value heating (F11 - 1)						0.01 to 650 $\frac{\text{m}^3}{\text{h}}$
Max. limit value DHW (F11 - 1)						0.01 to 650 $\frac{\text{m}^3}{\text{h}}$
Limiting factor (F11 - 1)						0.1 to 10.0
Binary input bE (F12 - 1)						1, 0

Parameters in level 7

Function block parameters (CO7)	Level 7	Range of values
Device bus address (F01 - 1)		Auto, 1 to 32
Device bus address (F03 - 1, room panel Rk1)		Auto, 1 to 32
Device bus address (F04 - 1, room panel Rk2)		Auto, 1 to 32
Register no. (F06 - 1)		1 to 4
Register no. (F07 - 1)		1 to 4
Register no. (F09 - 1)		1 to 4
Register no. (F10 - 1)		5 to 64
Register no. (F11 - 1)		5 to 64
Register no. (F13 - 1)		5 to 64
Register no. (F14 - 1)		5 to 64
Register no. (F15 - 1)		5 to 64
Register value for active DHW heating (F20 - 1)		0, 1
Register no. (F20 - 1)		5 to 64
Register no. (F21 - 1)		5 to 64
Register no. (F22 - 1)		5 to 64

Index

A

Adaptation 55
 Alarm, excess temperature 82
 Automatic operation 8

B

Boiler systems 29

C

Calibrating sensors 25
 Changeover key 6
 Condensate accumulation control 68
 Configuration level 22, 89
 Connection
 Actuator 87
 Controller 86
 Pump 87
 Sensor 87
 Controller time 11
 Creep feed rate limitation 74
 Customer data 110

D

Day mode 8
 Default settings 26
 Demand processing
 Using the device bus 75
 Device bus 74
 DHW heating
 in the storage tank charging system 59
 in the storage tank system 56
 time-controlled switchover of storage tank
 sensors 57, 60
 Display 9
 Drying of jointless floors 48

E

Electrical connection 86 - 88
 Errors 81
 issued by device bus 78
 Extended operating level 15

F

Fixed set point control 47
 Flash adaptation
 outdoor temperature dependent 53
 room temperature dependent 54
 Flow rate limitation 72
 Forced charging, DHW storage tank 64
 Forced operation, pumps 67
 Frost protection 66
 Function block lists 89
 Function block number 22
 Functions 22

G

Gradient characteristic 45

H

Heat capacity limitation 72
 Heating characteristic 44

I

Installation
 Panel mounting 84
 Wall mounting 84
 Intermediate heating operation 62

J

Jointless floors 48

K

Key number 21

- L**
- Level structure 20
 - Limitation
 - Using pulse input 72
 - Locking manual level 79
- M**
- Manual operation 8, 27
 - Memory module 83
- N**
- Night mode 8
- O**
- On/off control 69
 - Operating elements 6
 - Operating modes 8
 - Operational faults 81 - 82
 - Optimization 52
 - Outdoor temp. adaptation, delayed 51
 - Overvoltage protection 86
- P**
- Parallel operation, pumps 62
 - Parameter level 24
 - Parameter lists 100
 - Parameters 24
 - Party mode 14
 - Primary controller 75
 - Priority
 - DHW heating 63
 - over all controllers, via device bus 77
 - Processing of external demand 70
 - Public holidays 16
- R**
- Rated operation 8
 - Reduced operation 8
 - Release control loop (binary input) 69
 - Remote operation 51
 - Resistance values 108
 - Return flow temperature limitation
 - with P algorithm 67
 - Reverse control 63
 - Room sensors
 - Pt 1000 51
 - PTC 51
 - Rotary pushbutton 6
 - Rotary switch
 - DHW circuit 7
 - Heating circuit 7
 - Rotary switches
 - Assignment 107
- S**
- Secondary controller 76
 - Sensor failure 81
 - Set point
 - Day 45
 - Night 45
 - Set-back operation 63
 - Steam pressure control 67
 - Summer mode 50
 - Summer time/winter time changeover 66
 - Synchronizing 77
 - System code number 21
 - Systems 28 - 43
- T**
- Technical data 109
 - Temperature monitoring 82
 - Temperature set points 19
 - Thermal disinfection 64
 - Three-step control 69
 - Time-controlled operation 8
 - TROVIS-VIEW 83
- U**
- Underfloor heating 48

V

Vacation periods 17

W

Weather-compensated control. 44

Wiring diagram. 88

Key number:

1732

Frequently used abbreviations

<i>AF</i>	Outdoor sensor	<i>KI</i>	Terminal	<i>TLP</i>	Exchanger charging pump
<i>AnI</i>	System	<i>KW</i>	Cold water	<i>TWE</i>	Domestic hot water
<i>BA</i>	Binary output	<i>OT</i>	Outdoor temperature	<i>UP</i>	Circulation pump
<i>BE</i>	Binary input	<i>PA</i>	Parameter level	<i>VF</i>	Flow sensor
<i>CO</i>	Configuration level	<i>RF</i>	Room sensor	<i>WE</i>	Default setting
<i>DHW</i>	Domestic hot water	<i>Rk</i>	Control circuit	<i>WW</i>	Hot water
<i>EB</i>	Mounting and Operating Instructions	<i>RüF</i>	Return flow sensor	<i>ZP</i>	Circulation pump
<i>F</i>	Function block	<i>SF</i>	Storage tank sensor		
<i>HK</i>	Heating circuit	<i>SLP</i>	Storage tank charging pump		
<i>GLT</i>	Building control station	<i>t</i>	Time		
		<i>T</i>	Temperature		

Type 1

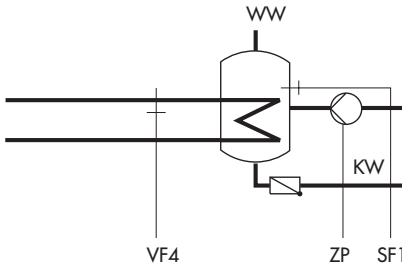

Type 2

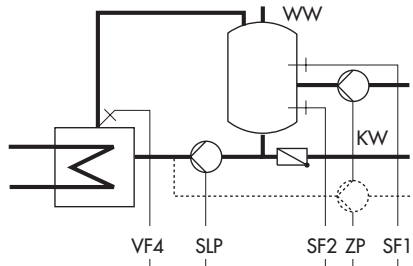

Type 3

Solar collector

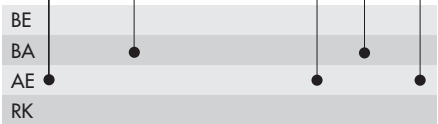
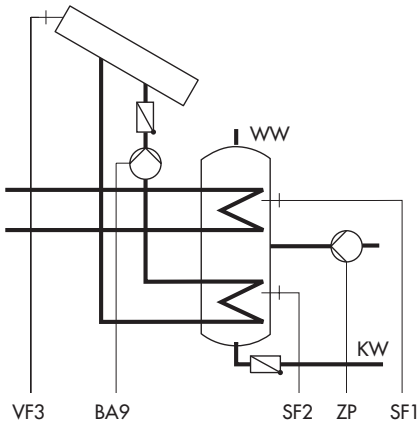



SAMSON AG · MESS- UND REGELTECHNIK
Weismüllerstraße 3 · 60314 Frankfurt am Main · Germany
Phone: +49 69 4009-0 · Fax: +49 69 4009-1507
Internet: <http://www.samson.de>

EB 5575 EN

2006-01