

TROVIS 5600 Automation System
TROVIS 5610
Heating and District Heating Controller



Mounting and Operating Instructions

EB 5610 EN

Firmware version 1.1x
Edition November 2013

Controller versions

The TROVIS 5610 Heating and District Heating Controller is available in two different versions:

- Compact version with one control circuit
- Standard version with two control circuits

Both versions are described in Mounting and Operating Instructions EB 5610 EN.

Definitions of the signal words used in these instructions

DANGER!

indicates a hazardous situation which, if not avoided, will result in death or serious injury.

WARNING!

indicates a hazardous situation which, if not avoided, could result in death or serious injury.

NOTICE

indicates a property damage message.

Note: *Supplementary explanations, information and tips*

Contents	Page
1	Safety instructions 6
1.1	Start-up 6
1.2	Disposal 7
2	Operation 8
2.1	Information menu 10
2.1.1	Retrieving information 11
2.2	Operation menu 13
2.2.1	Selecting the operating mode 14
2.2.2	Defining special times-of-use 15
2.3	Times-of-use menu 17
2.3.1	Changing the times-of-use 17
3	Setup settings 20
3.1	Changing set points and deactivation values 22
3.2	Altering the screen contrast or brightness 24
3.3	Changing the system date and time. 25
3.4	Calibrating the display. 26
3.5	Cleaning the display. 27
3.6	Changing the language setting. 27
3.7	Configuring the controller and changing parameter settings. 28
3.7.1	Changing the system code number 29
3.7.2	Activating or deactivating functions. 29
3.8	Setting parameters. 31
4	Manual mode. 32
5	Systems. 34
6	Functions of the heating circuit. 52
6.1	Weather-compensated control 52
6.1.1	Gradient characteristic. 53
6.1.2	Four-point characteristic 56
6.2	Fixed set point control 57
6.3	Underfloor heating/drying of jointless floors 58
6.4	Deactivation based on the outdoor temperature. 59
6.4.1	HC deactivation value (day) 59
6.4.2	HC deactivation value (night). 59
6.4.3	Outdoor temperature for continuous rated operation (day) 60
6.4.4	Summer mode. 60
6.5	Delayed outdoor temperature adaptation 61

6.6	Remote operation	61
6.7	Optimization	62
6.7.1	Optimization based on outdoor temperature	62
6.7.2	Optimization based on room temperature	62
6.7.3	Optimization based on outdoor and room temperature	63
6.8	Flash adaptation.	64
6.8.1	Flash adaptation without outdoor sensor (based on room temperature).	65
6.9	Adaptation	65
6.10	Set point correction using a 0 to 10 V signal	66
7	Functions of the DHW circuit.	67
7.1	DHW heating in the storage tank system	67
7.2	DHW heating in the storage tank charging system	69
7.2.1	Circulation return flow in heat exchanger	72
7.3	DHW heating in instantaneous heating system	73
7.4	Intermediate heating operation.	74
7.5	Parallel pump operation	74
7.6	Circulation pump operation during storage tank charging.	75
7.7	Priority operation	75
7.7.1	Reverse control	75
7.7.2	Set-back operation	76
7.8	Forced charging of the DHW storage tank	77
7.9	Thermal disinfection of the DHW storage tank	77
8	System-wide functions.	79
8.1	Automatic summer time/winter time switchover	79
8.2	Frost protection	79
8.3	Forced operation of the pumps.	80
8.4	Return flow temperature limitation	80
8.5	Condensate accumulation control	81
8.6	Three-step control	82
8.7	On/off control.	82
8.8	Unlocking a controller/control loop 1 over the binary input	83
8.9	Processing an external demand	84
8.9.1	Processing an external demand with a binary signal	84
8.9.2	Processing an external demand with a 0 to 10 V signal	85
8.10	Demand requested with a 0 to 10 V signal	85
8.11	Forwarding the measured outdoor temperature	85
8.12	Locking the manual level.	86
9	Operational faults.	87

9.1	Sensor failure	88
9.2	Temperature monitoring	88
9.3	Collective fault alarm	89
10	Installation	90
11	Electrical connection	92
12	Interfaces	96
12.1	Memory pen	97
12.2	TROVIS-VIEW	97
13	Appendix	98
13.1	Configuration levels	98
13.2	Parameter levels	108
13.3	Sensor resistance tables	112
13.4	Technical data	113
13.5	Customer data	114
	Index	119

Revisions of heating controller firmware	
1.00 (old)	1.05 (new)
	Internal revisions
1.05 (old)	1.10 (new)
	New system no. 11.2.0 (see p. 49)
	New function: Release of control circuit 2 at S8 (see p. 104)
	New COM reset parameter (see p. 111)

1 Safety instructions

For your own safety, follow these instructions concerning the mounting, start-up and operation of the controller:

- ▶ The device may only be mounted, started up or operated by trained and experienced personnel familiar with the product.
- ▶ The controller has been designed for use in electrical power systems. For wiring and maintenance, you are required to observe the relevant safety regulations.

To avoid damage to any equipment, the following also applies:

- ▶ Proper shipping and appropriate storage are assumed.

1.1 Start-up

To start up the controller, follow the instructions below in the order described.

1. Install the controller and connect the wiring. Refer to sections 10 and 11.

NOTICE

The wiring differs depending on the system. Refer to sections 5 and 11.

After the controller is connected to the power supply for the first time, a start-up wizard automatically starts. This start-up wizard guides the user to set up the controller and select the language, system time and system code number. After start-up, the controller is ready for use.

The user can change the settings at any time. Refer to sections 3.3, 3.6 and 3.7.1.

2. Activate required functions and deactivate any functions that are not required. Refer to section 3.7.2.
3. Set the parameters. Refer to section 3.8.
4. Enter the set points and deactivation values. Refer to section 3.1.

1.2 Disposal

Waste electrical and electronic equipment may still contain valuable substances. They may also, however, contain harmful substances which were necessary for them to function. For this reason, do not dispose this kind of equipment together with your other household waste. Instead, dispose of your waste equipment by handing it over to a designated collection point for the recycling of waste electrical and electronic equipment.

2 Operation

Note: A start-up wizard starts automatically when the controller is started for the first time. You must complete all the steps of the wizard before the controller can be fully used.

The TROVIS 5610 Controller has an interactive touch screen. The backlight of the touch screen is active while the controller is being operated. Approximately five minutes after the last key has been pressed, the backlight is automatically dimmed.

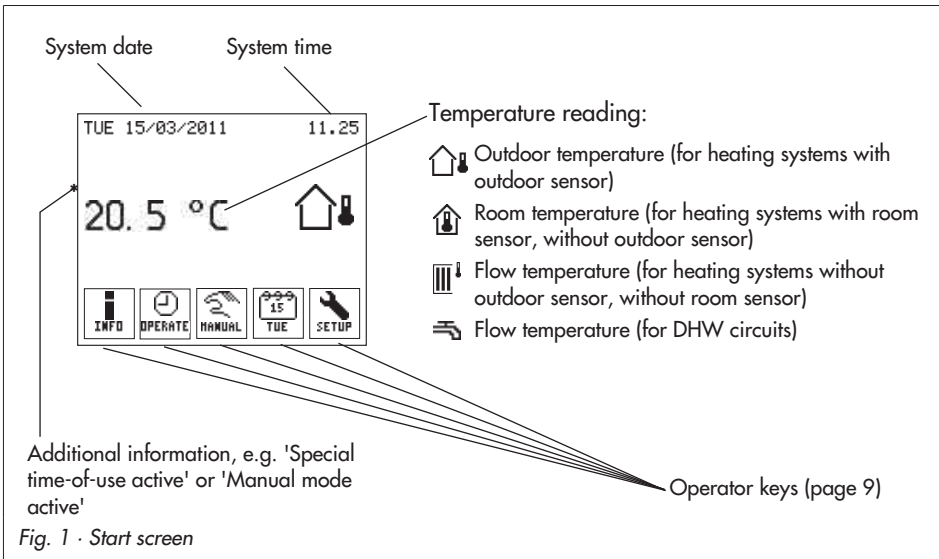

The operator keys on the start screen can be used to go to the various menus for operation and setup:

- ▶ **Information menu** with information on sensors, operating modes, system and controller
- ▶ **Operation menu** for setting the operating mode and special times-of-use
- ▶ **Manual menu** for setting the controller outputs
- ▶ **Times-of-use menu** for setting the time schedules
- ▶ **Setup menu** for entering the set points and deactivation values, changing the brightness, contrast or language, performing a display calibration, selecting a system or changing the configuration and parameter settings

Operator keys



Press this key to go to the Information menu.
This key only appears when no errors exist.



Press this key to go to the Information menu and the Error menu item.
This key blinks when the controller has detected an error.



Press this key to go to the Operation menu.
This key only appears when manual mode is inactive.



Press this key to exit the manual mode.
This key only appears when manual mode is active.



Press this key to go to the Manual menu.



Press this key to go to the Times-of-use menu.
The current day of the week (MON, TUE, WED, THU, FRI, SAT, SUN) is displayed.



Press this key to go to the Setup menu.

Note: The displays shown in these instructions represent the displays seen when system Anl. 2.1.0 has been selected. This system consists of heating circuit 1 (HC1) and DHW heating (DHW).

Menu items relating to control circuits are only displayed when the configured system has the corresponding control circuit.

2.1 Information menu

The Information menu contains current details on the control process and the controller. If the controller detects an error, an error list is displayed on the first screen of the Information menu. Refer to section 9.

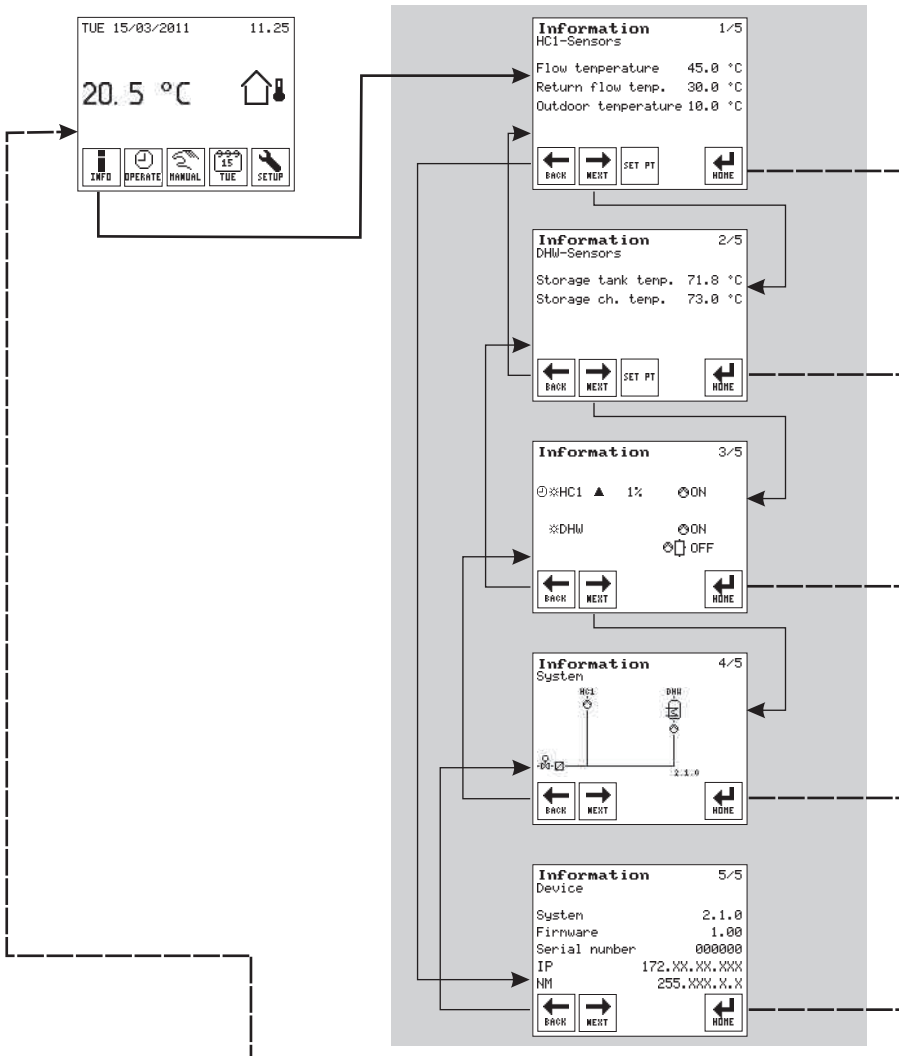

2.1.1 Retrieving information

The following instructions describe the procedure starting from the start screen (see page 8). No errors exist in the example below.



Open the Information menu.

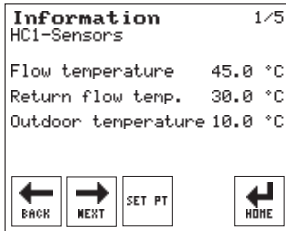

Sensor data

The screen displays information on the HC1 sensors. The measured temperatures of the control circuit (specified in the second row) are shown on the screen.

Standard version and heating systems with two control circuits:



Select screen displaying information on the DHW sensors for DHW heating, if required.



Read set points.

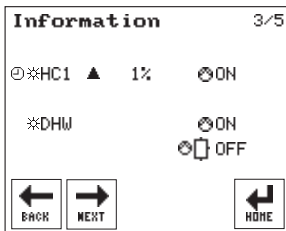

Select screen displaying an overview.

Overview of control circuit

Operating modes, valve position and pump states are displayed depending on the control circuit.

The symbols have the following meaning:

Operating mode: ☀ Day

☾ Night

⊞ Stand-by

⌚☀ Automatic and day

⌚☾ Automatic and night

⌚⊞ Automatic and stand-by

Valve position: ▲ opens, ▼ closes

⊞ Heating pump, circulation pump (DHW)

⊞⊞ Heat exchanger charging pump

⊞⊞ Storage tank charging pump

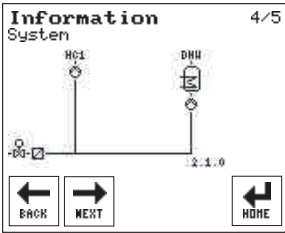

Select screen displaying information on the system.

Information on the system

This screen shows the schematics of the currently selected system.

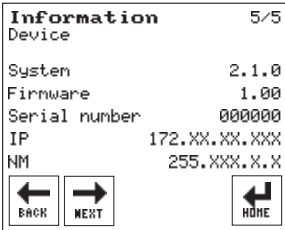

Select screen displaying information on the device (controller).

Information on the device (controller)

The currently selected system code number, the controller firmware and the serial number are listed.



Return to start screen.

2.2 Operation menu

The operating mode is selected in the Operation menu.

The Operation menu cannot be selected when the controller is in manual mode. In this case, you must first exit the manual mode (→ Section 4).

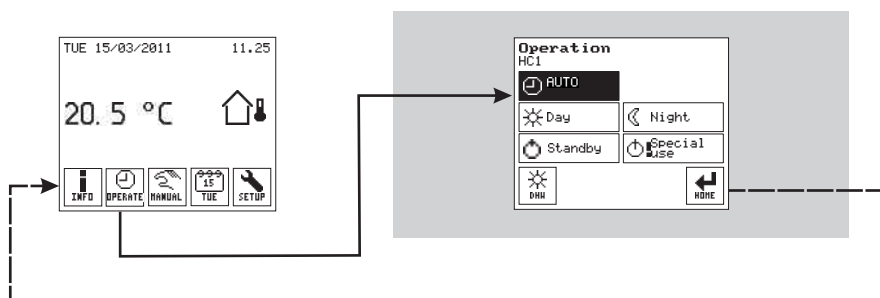

The following operating modes are available.

 **Auto:** The controller uses the day set points within the times-of-use and the night set points outside the times-of-use (→ Section 3.1).

If the times-of-use have not been changed, the controller uses the day set points between 06:00 and 22:00 h for control (→ Section 2.3).

The heating circuit is deactivated accordingly when the heating circuit has an outdoor sensor and the outdoor temperature exceeds the HC day or night deactivation value (→ Section 3.1).

 **Day:** Regardless of the programmed times-of-use and summer mode, the days set points are used by the controller (→ Section 3.1).

The heating circuit **continues** to run when the heating circuit has an outdoor sensor and the outdoor temperature exceeds the HC day deactivation value (→ Sections 3.1 and 6.4.1).

 **Night:** Regardless of the programmed times-of-use, the night set points are used by the controller (Setting the set points → Section 3.1).

The heating circuit is deactivated when the heating circuit has an outdoor sensor and the outdoor temperature exceeds the HC night deactivation value (→ Sections 3.1 and 6.4.2).

 **Stand-by:** Regardless of the programmed times-of-use, the control process is deactivated. Only the frost protection is activated, if required.

When outdoor temperatures below the adjustable 'Outdoor temperature for frost protection' are registered, the frost protection symbol  appears on the screen instead of  (→ Section 8.2).

 **Special times-of-use:** The controller switches to the day, night or stand-by mode regardless of the adjusted operating mode. In this way, the following special uses can be defined:

- ▶ **Party mode:** The day mode continues to run (day set points are used) even after the time-of-use has finished.
- ▶ **Public holiday mode:** The day mode is extended (day set points are used) to a continuous time-of-use, e.g. on public holidays
- ▶ **Vacation mode:** Night mode or stand-by mode activated for long periods, e.g. during vacations

A maximum of ten time periods can be defined in which the controller switches to day, night or stand-by mode regardless of the programmed operating mode.

After a defined special time-of-use has elapsed, it is automatically deleted.

2.2.1 Selecting the operating mode

The following instructions describe the procedure starting from the start screen (see page 8). The controller is running in normal control operation in this example.

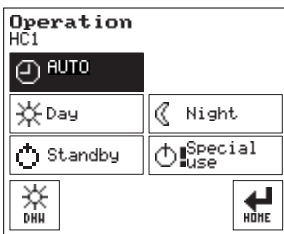

Open the Operation menu.

The current operating mode of the control circuit (specified in the second row) is activated (dark background).

Standard version and heating systems with two control circuits:



Open Operation menu for DHW heating, if required.

Note: The symbol in the key indicates which operating mode is currently active for the control circuit.

Select the operating mode that you required.

Define special time-of-use (→ Section 2.2.2) or

 Return to start screen.

2.2.2 Defining special times-of-use

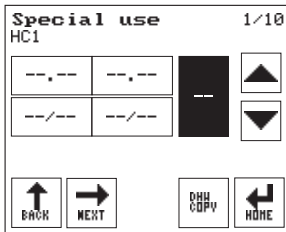

The following buttons appear:

2 --:--	3 --:--	1	1 Operating mode
4 --. --.	5 --. --.	--	2 Start time 3 Stop time
			4 Start date 5 Stop date

The operating mode button (1) is activated.

 Select the operating mode for the special time-of-use:

☀ day, 🌙 night, ⏸ stand-by, -- time inactive

The start and stop times are set to the current time (hour), while the start and stop dates are set to the current date.

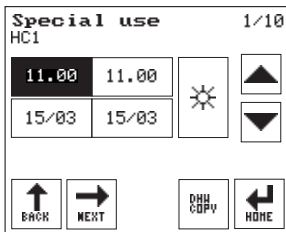

Press the start time button (2).

 Set the start time (in steps of 15 minutes).



Press the stop time button (3).

 Set the stop time (in steps of 15 minutes).



Note: If the start time or date is selected to be after the stop time or date, 'Invalid entry' blinks on the screen. This message is deleted as soon as the start time or date is corrected and set before the stop time or date.

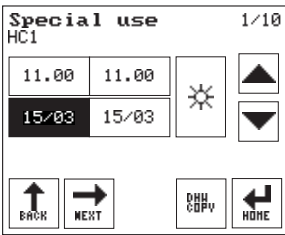

Press the start date button (4).

▲
 ▼
Set the start date.

Press the stop date button (5).

▲
 ▼
Set the stop date.

Note: If the special time-of-use is only to be valid for one day, set the start and stop dates to the same date.

Standard version and heating systems with two control circuits:

DHW COPY If required, copy the special times-of-use settings for the heating circuit to the DHW circuit.

HC COPY If required, copy the special times-of-use settings for the DHW circuit to the heating circuit.

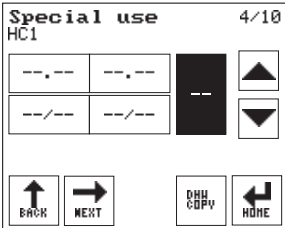

→ NEXT Select further special time-of-use (2/10, ..., 10/10).

Set other special times-of-use in the same manner as described above.

▲ BACK Return to Operation menu or

↶ HOME Return to start screen.

2.3 Times-of-use menu

Three times-of-use can be programmed for each day of the week in the Times-of-use menu. The time can be set between 00:00 and 24:00 h. The times-of-use are programmed separately for each control circuit. The controller is delivered with the following default times-of-use:

- ▶ Times-of-use for heating circuit HC1: 06:00 to 22:00 h
- ▶ Times-of-use for DHW heating: 00:00 to 24:00 h
- ▶ Times-of-use for circulation pump (DHW CP): 00:00 to 24:00 h

In automatic mode, the day set points are used during the times-of-use and the night set points outside the times-of-use.

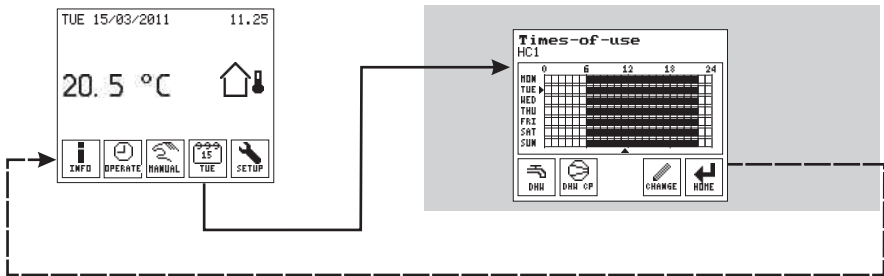

2.3.1 Changing the times-of-use

The following instructions describe the procedure starting from the start screen (see page 8).



Open Times-of-use menu.

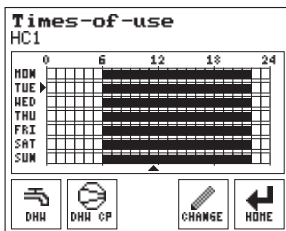

The times-of-use for the control circuit (specified in the second row) are indicated by black bars for each day of the week. The arrows indicate the current day and time.

Standard version and heating systems with two control circuits:



If required, open the Operation menu for DHW heating.

Systems with DHW heating:



If required, open the Operation menu for the circulation pump (DHW CP).

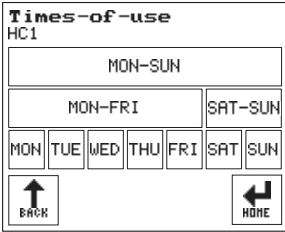

Press to change the times-of-use.



Select period to be changed:

- [MON-SUN] to change the times-of-use to be identical for the entire week
- [MON-FRI] to change the times-of-use to be identical for all weekdays
- [SAT-SUN] to change the times-of-use to be identical at the weekend
- [MON], [TUE], [WED], [THU], [FRI], [SAT], [SUN] to change the times-of-use individually for each day of the week

Note: The settings for individual days [MON], [TUE] etc. have priority over the settings for multiple days. The settings for weekdays [MON-FRI] and weekend [SAT-SUN] have priority over the setting for the entire week [MON-SUN].

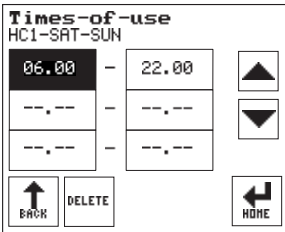

The following buttons appear:

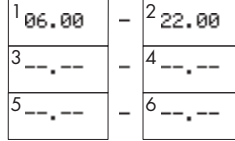

- 1 Start time 2 Stop time 1st time
- 3 Start time 4 Stop time 2nd time
- 5 Start time 6 Stop time 3rd time



Press the start time button (1, 3 or 5).



Set the start time.





Press the stop time button (2, 4 or 6).



Set the stop time.

Deleting times-of-use

 Press the start or stop time button of the time-of-use you want to delete.

 Delete the time-of-use.

 Return to Time-of-use menu or

 Return to start screen.

3 Setup settings

In the Setup menu, you can change settings that were made with the Start-up wizard:

- ▶ Change the language (refer to section 3.6)
- ▶ Change the system time (refer to section 3.3)
- ▶ Change the system code number (refer to section 3.7.1)

In addition, the controller can be adapted to your requirements:

- ▶ Change set points and deactivation values (refer to section 3.1)
- ▶ Activate or deactivate functions (refer to section 3.7.2)
- ▶ Set parameters (refer to section 3.8)

Furthermore, the controller can be adapted to the location where it is installed by changing the display settings. The display can be recalibrated:

- ▶ Alter contrast and brightness (refer to section 3.2)
- ▶ Calibrate the display (refer to section 3.4)

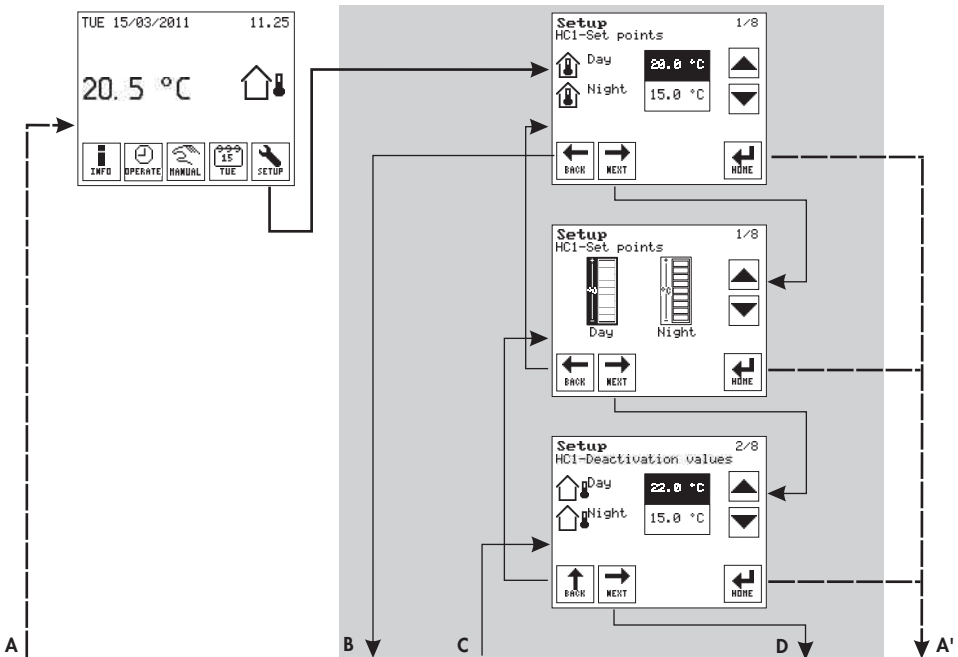

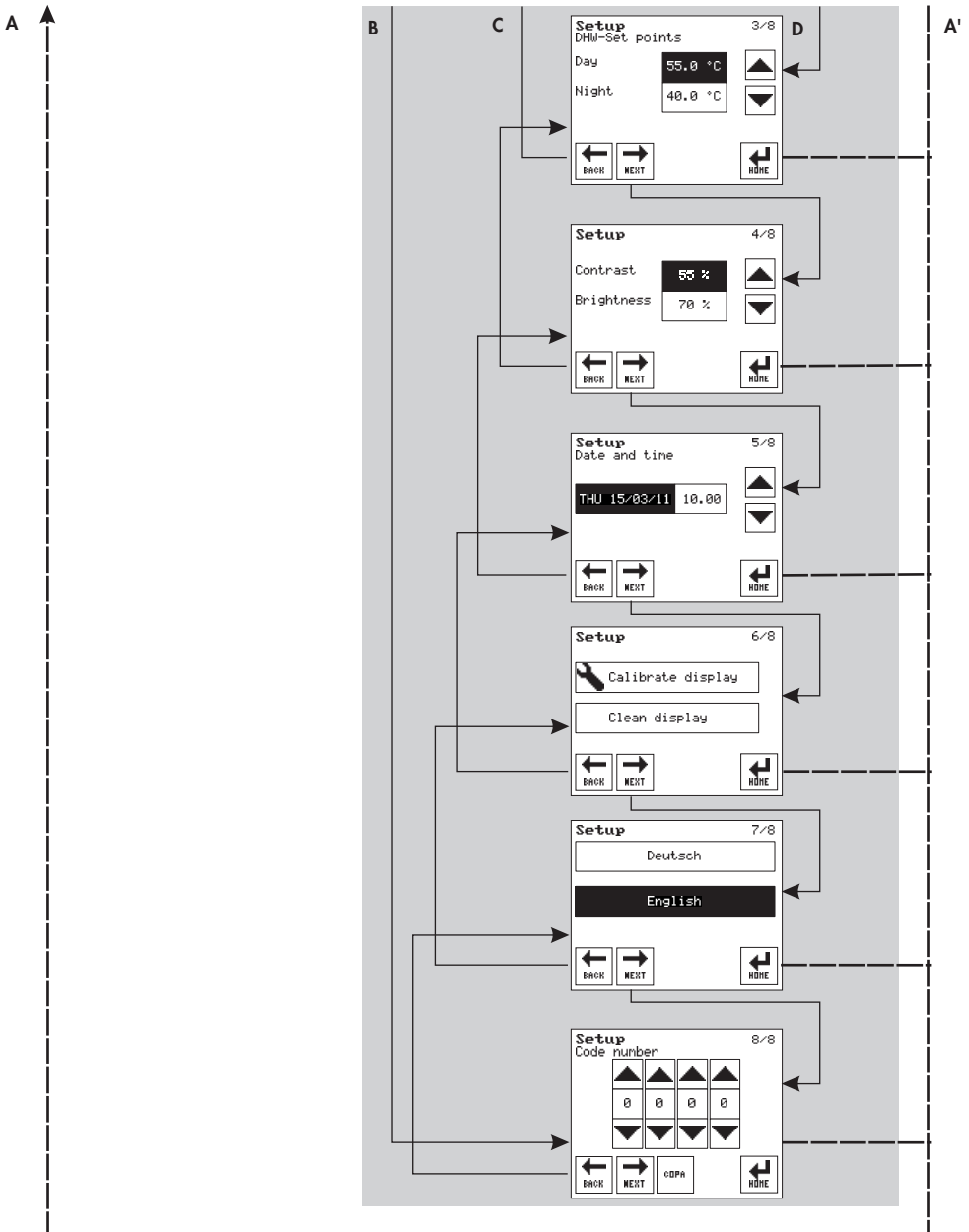

3.1 Changing set points and deactivation values

You can adapt the control process to your individual requirements by simply changing set points and deactivation values.

HC1 set points

The HC1 set points can be defined to raise or reduce the room temperature during the times-of-use (day) or outside the times-of-use (night).

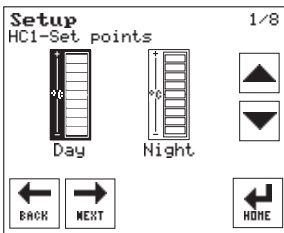

In systems without room sensor, the exact room temperature is not known. The set points are raised or reduced by 2 K in four stages.

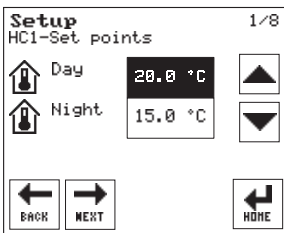

In systems with room sensor, the room temperature of the reference room in which the room sensor is located is defined by changing an absolute value.

DHW set points

The DHW temperature during the times-of-use (day) and outside the times-of-use (night) can be defined by changing DHW set points. The set points are defined by changing an absolute value.

HC1 deactivation values

The HC1 deactivation values can be defined for heating circuit HC1 when the heating circuit has an outdoor sensor AS.

The HC deactivation values can be used to switch the heating circuit HC1 dependent on the outdoor temperature during the times-of-use (day) and outside the times-of-use (night): The heating circuit is deactivated when the outdoor temperature exceeds the deactivation value. The heating circuit is reactivated when the outdoor temperature falls below the deactivation value again.

Changing set points and deactivation values

The following instructions describe the procedure starting from the start screen (see page 8).

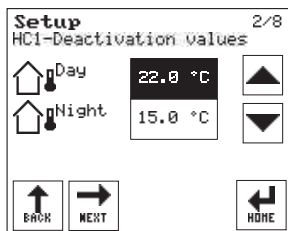

Open the Setup menu.

The set points for the control circuit (specified in the second row) are shown. The current day set point is activated (dark background).

Standard version and heating systems with two control circuits:



If required, select the set points for DHW heating.



If required, select the button for night set point.



Change the set point.



If required, select the button for deactivation values.



If required, select the button for night deactivation value.



Change the deactivation value.



Perform further changes in the Setup menu or



Return to start screen.

3.2 Altering the screen contrast or brightness

You can alter the contrast and brightness of the screen.

The following instructions describe the procedure starting from the start screen (see page 8).

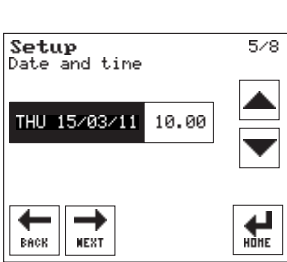

Open the Setup menu.



Select menu item for contrast and brightness.

The current contrast setting is activated (dark background).



Adjust contrast.



Press button for brightness setting.



Adjust brightness.











Perform further changes in the Setup menu or

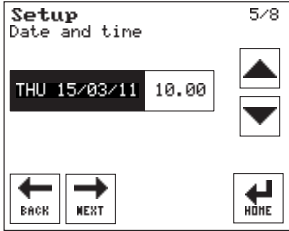

Return to start screen.

3.3 Changing the system date and time

The following instructions describe the procedure starting from the start screen (see page 8).

- 
- Setup** 5/8
Date and time
- THU 15/03/11 10.00
- BACK NEXT HOME
-  Open the Setup menu.
 -  Select menu item for date and time.
The date setting button is activated (dark background).
 - 
 Change the date.
 - Press button for the time setting.
 - 
 Change the time.
 -  Perform further changes in the Setup menu or
 -  Return to start screen.

3.4 Calibrating the display

Calibration improves the precision of the touch screen. If you notice that the touch screen does not respond correctly when you press keys on the screen, perform a calibration.

The following instructions describe the procedure starting from the start screen (see page 8).

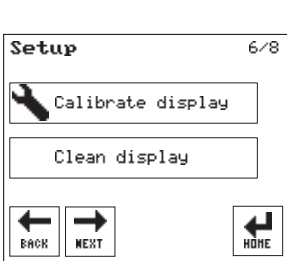

Open the Setup menu.



Select menu item for calibrate/clean display.



Press 'Calibrate display' button.

A cross (+) appears at different places on the touch screen in sequence.



Touch the cross repeatedly.

The calibrating process is completed when the 'Calibrate display' and 'Clean display' buttons reappear.



Perform further changes in the Setup menu or



Return to start screen.



3.5 Cleaning the display

NOTICE

Do not use solvents to clean the touch screen!

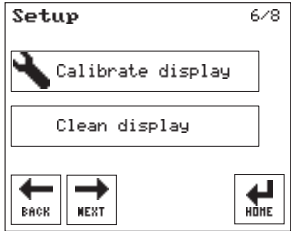
The following instructions describe the procedure starting from the start screen (see page 8).





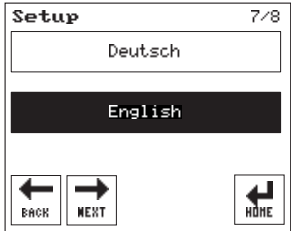

-  Open the Setup menu.
-  Select menu item for calibrate/clean display.
- Press 'Clean display' button.
The touch screen is deactivated for 30 seconds. During the countdown, the display can be cleaned with a damp microfiber cloth.
-  Return to start screen.

3.6 Changing the language setting

The following instructions describe the procedure starting from the start screen (see page 8).



-  Open the Setup menu.
-  Select menu item for language.
The current language setting is activated (dark background).
- Press the language required.
-  Perform further changes in the Setup menu or
-  Return to start screen.







3.7 Configuring the controller and changing parameter settings

To adapt the controller to your control requirements, you can activate or deactivate functions as required. Depending on the activated functions, function block parameters and single parameters can also be adapted to individual requirements. Functions and parameters are described in sections 6, 7 and 8.

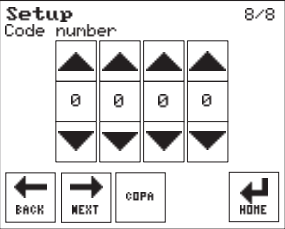
The functions and parameters are assigned to the individual configuration and parameter levels depending on the controller action required (overview of all functions and parameter levels → Sections 13.1 and 13.2):

- ▶ Screen displaying the system schematics
- ▶ Configuration level (CO level):
 - HC1–CO1 (only for systems with HC1)
 - DHW–CO4 (only for systems with DHW)
 - HC1–CO5
- ▶ Parameter levels (PA levels):
 - HC1–PA1 (only for systems with HC1)
 - DWW–PA4 (only for systems with DHW)

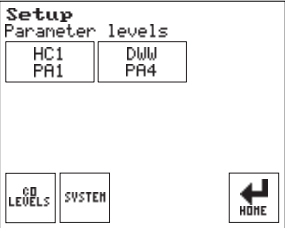
The system configuration and parameter settings can only be changed after you enter a valid key number. The valid key number is stated on page 123.

	<p> Open the Setup menu.</p> <p> Select the menu item for the key number. The key number 0000 appears.</p> <p> Enter the valid key number.</p>
	<p> Open the configuration and parameter level. The various parameter levels belonging to the currently selected system are shown.</p>

3.7.1 Changing the system code number

Any setup settings that have been made are reset when the system code number is changed.

NOTICE

The wiring differs depending on the system. Before changing the system code number, the electrical connections may need to be changed. Refer to sections 5 and 11.

The following instructions start from the configuration and parameter level (see page 28).

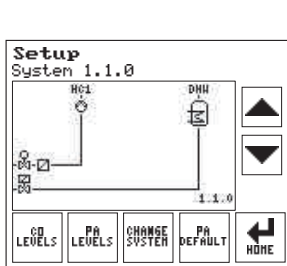

Open the screen displaying the system schematics.

The schematics of the currently valid system are shown (see section 5).



Select a different system.



Confirm the new system.

'System saved' appears on the screen.



Return to start screen.

3.7.2 Activating or deactivating functions

The following instructions start from the configuration and parameter level (see page 28).



Select the menu item for configuration levels.

The various configuration levels of the currently valid system appear.

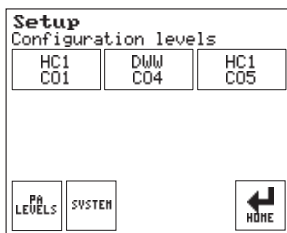



Select the configuration level. Depending on the currently valid system:

- ▶ HC1-CO1
- ▶ DHW-CO4
- ▶ HC1-CO5

Setup							1/14				
HC1-C01-List											
01	0	02	1	03	1	04	0	05	0	06	0
11	0	12	1	13	0	14	0	15	0	16	0
17	0										





 BACK

 BACK









 NEXT

 HOME

The function blocks of the activated configuration levels are shown together with their current setting (0 = OFF, 1 = ON).

- Go directly to the function block or
-  Select function blocks one after the other.
-  Activate or deactivate the function block.
- 

Function blocks with function block parameters:

-  Press function block parameter button.
-  Select a function block parameter.
-  Set the function block parameter.
- 
-  Return to the configuration level.
-  Go to the next configuration block or
-  Return to the configuration and parameter level or
-  Return to start screen.

3.8 Setting parameters

The following instructions describe the procedure starting from the configuration and parameter level (see page 28).

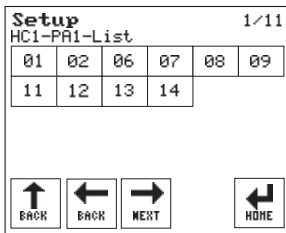

 Open the configuration and parameter level.
The various parameter levels of the currently valid system appear.

Select the parameter level.
The parameters of the activated parameter level are listed on the screen.

Go directly to the parameter or

 Select parameters one after the other.

 Set the parameter.



 Go to the next parameter or

 Return step-by-step to the configuration and parameter level or

 Return to start screen.

Note: All parameters can be reset to their default settings by pressing  in the system level (→ Section 3.7.1).

4 Manual mode

All outputs can be set in the manual mode:

- ▶ **M** (control valve): control output in percent
- ▶ **UP** (heating pump): switching pump on and off (ON/OFF)
- ▶ **SLP** (storage tank charging pump): switching pump on and off (ON/OFF)
- ▶ **ZP** (circulation pump): switching pump on and off (ON/OFF)

NOTICE

The heating is not monitored for frost protection in manual mode.

The following instructions describe the procedure starting from the start screen (see page 8).

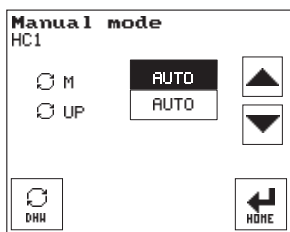

Open the Manual menu.
The outputs of the control circuit (specified in the second row) are shown.

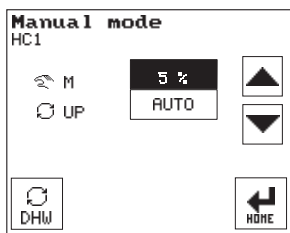

Select the output you want to control manually.



Set output.



The output immediately switches from automatic mode to the manual mode.

Standard version and heating systems with two control circuits:



Select the manual mode for DHW heating, if required.

Set the other outputs in the same manner as described above.

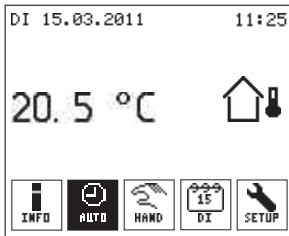



When all outputs have been set:



Return to start screen



The hand icon under the date indicates active manual operation.

The  key is replaced by the  key on the start screen.

Exit manual mode



Exit manual mode.

The  key is replaced by the  key on the start screen (see page 8).

5 Systems

System Anl 1.0.0

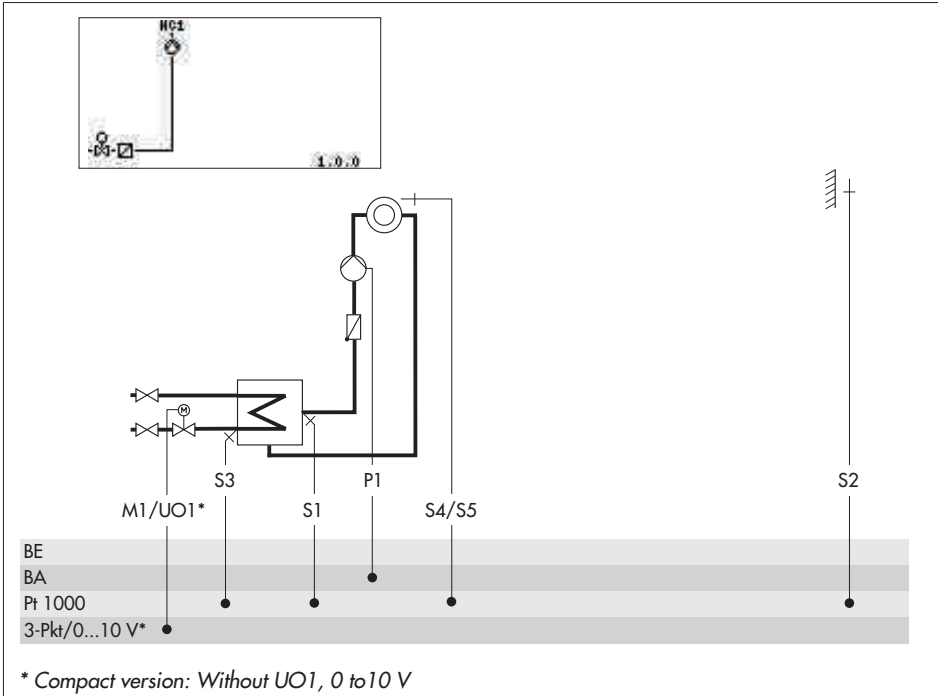

Default settings

HC1-CO1-01	OFF	(without S4/S5)
HC1-CO1-02	ON	(with S2)
HC1-CO1-03	ON	(with S3)

See fold-out page for wiring required for functions.

System Anl 1.0.1

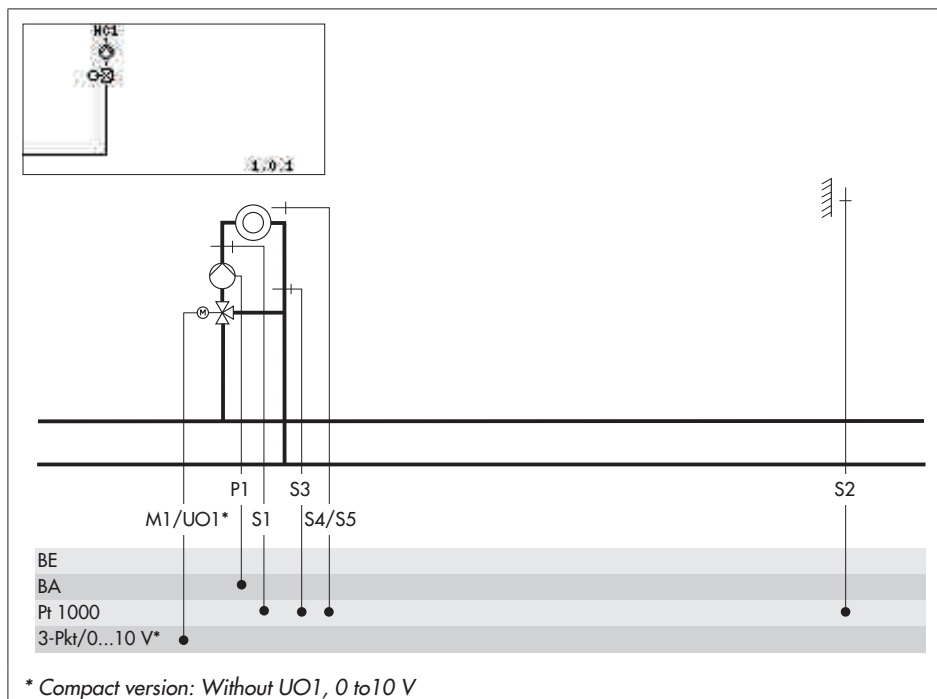

Default settings

HC1-CO1-01	OFF	(without S4/S5)
HC1-CO1-02	ON	(with S2)
HC1-CO1-03	OFF	(without S3)

See fold-out page for wiring required for functions.

System An1 1.1.0 (standard version only)

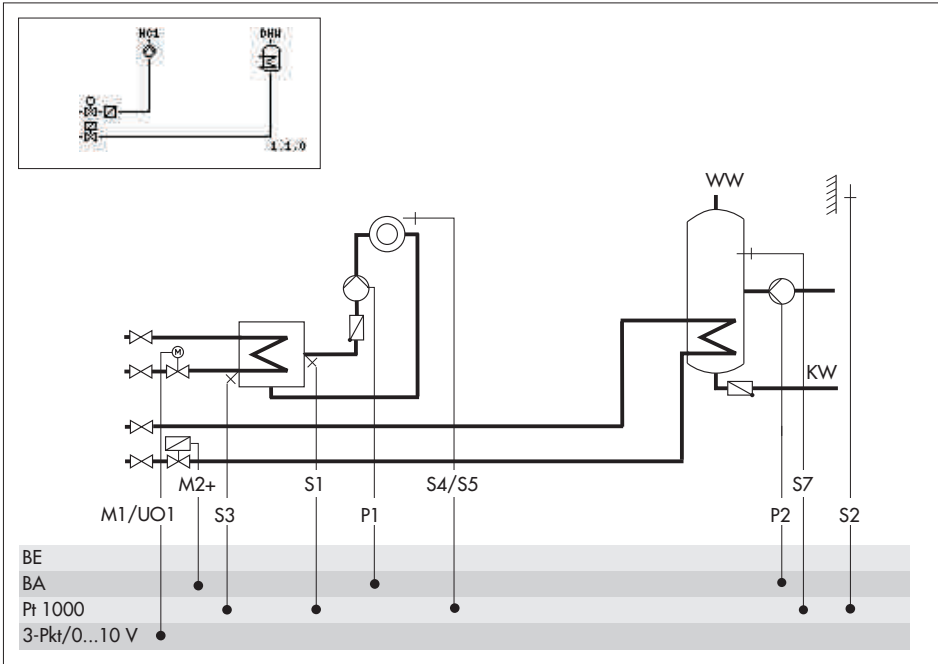

Default settings	
HC1-CO1-01	OFF (without S4/S5)
HC1-CO1-02	ON (with S2)
HC1-CO1-03	ON (with S3)
DHW-CO4-01	ON (with S7)

See fold-out page for wiring required for functions.

System An1 1.1.1 (standard version only)

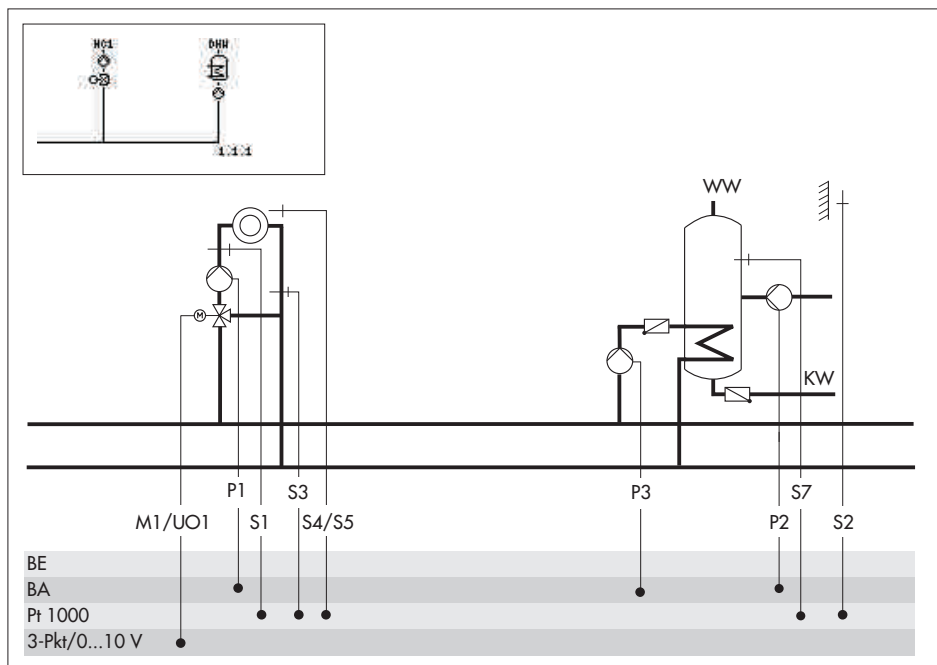
**Default settings**

HC1-CO1-01	OFF (without S4/S5)
HC1-CO1-02	ON (with S2)
HC1-CO1-03	OFF (without S3)
DHW-CO4-01	ON (with S7)

See fold-out page for wiring required for functions.

System An1 1.2.0 (standard version only)

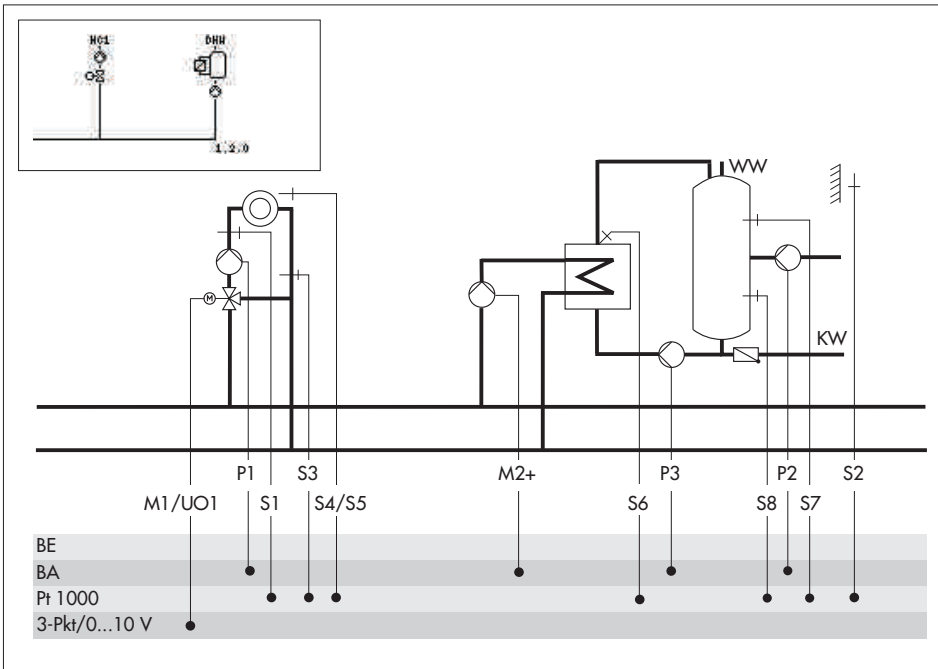

Default settings	
HC1-CO1-01	OFF (without S4/S5)
HC1-CO1-02	ON (with S2)
HC1-CO1-03	OFF (without S3)
DHW-CO4-01	ON (with S7)
DHW-CO4-02	ON (with S8)
DHW-CO4-05	OFF (without S6)

See fold-out page for wiring required for functions.

System Anl 1.6.0 (standard version only)

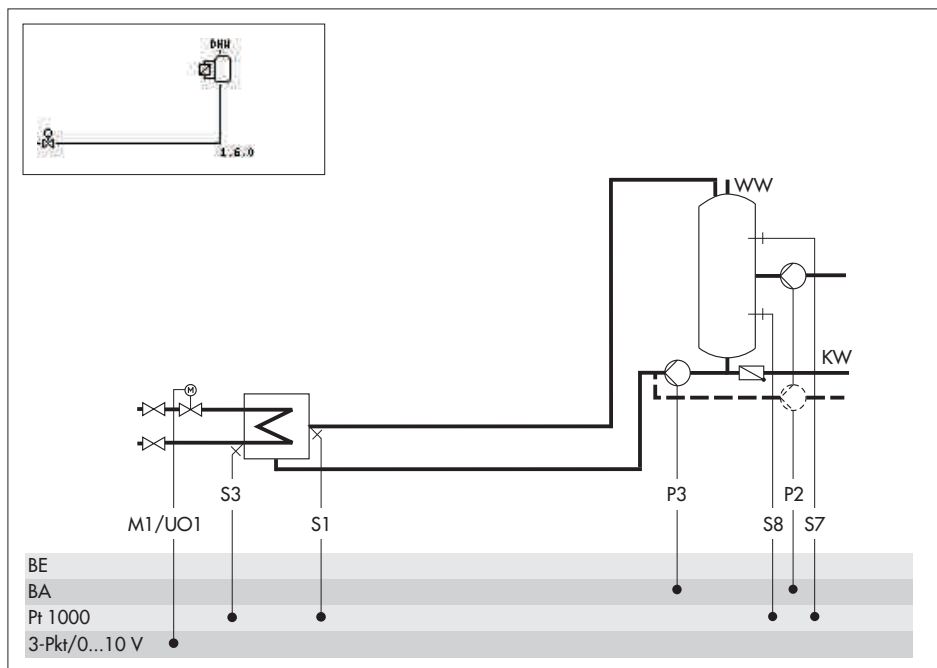
**Default settings**

DHW-CO4-01	ON (with S7)
DHW-CO4-02	ON (with S8)
DHW-CO4-03	ON (with S3)

See fold-out page for wiring required for functions.

System Anl 1.6.1 (standard version only)

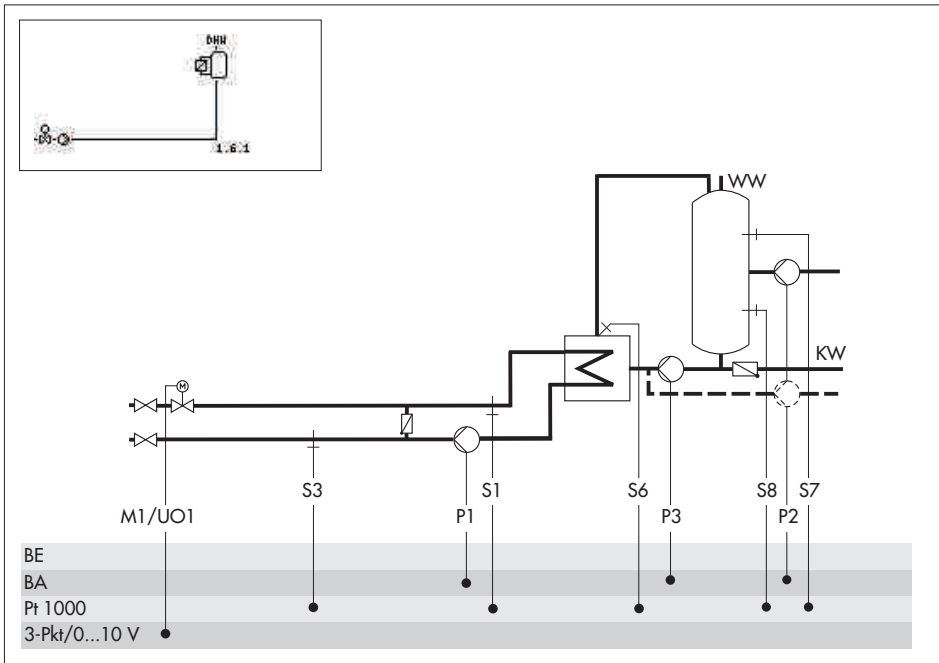

Default settings

DHW-CO4-01	ON	(with S7)
DHW-CO4-02	ON	(with S8)
DHW-CO4-03	ON	(with S3)
DHW-CO4-05	OFF	(without S6)

See fold-out page for wiring required for functions.

System Anl 1.6.2 (standard version only)

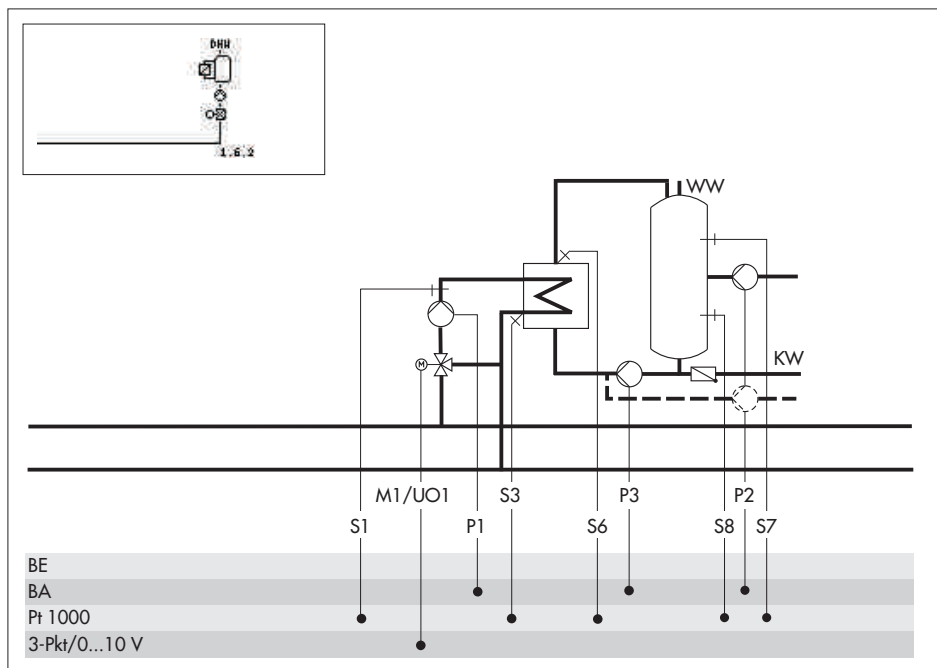
**Default settings**

DHW-CO4-01	ON (with S7)
DHW-CO4-02	ON (with S8)
DHW-CO4-03	OFF (without S3)
DHW-CO4-05	OFF (without S6)

See fold-out page for wiring required for functions.

System Anl 1.9.0

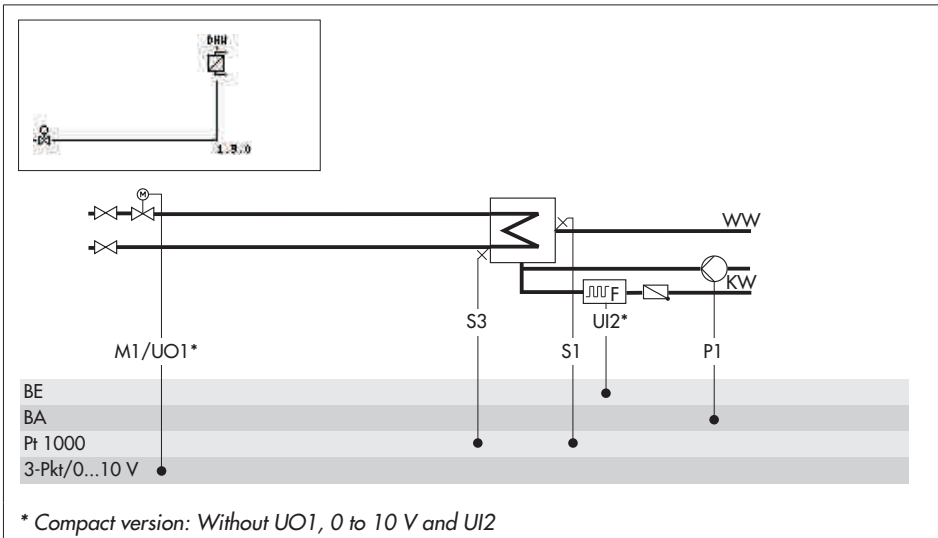

Default settings	
DHW-CO4-03	ON (with S3)
DHW-CO4-04	OFF (without UI2)

See fold-out page for wiring required for functions.

System Anl 1.9.1

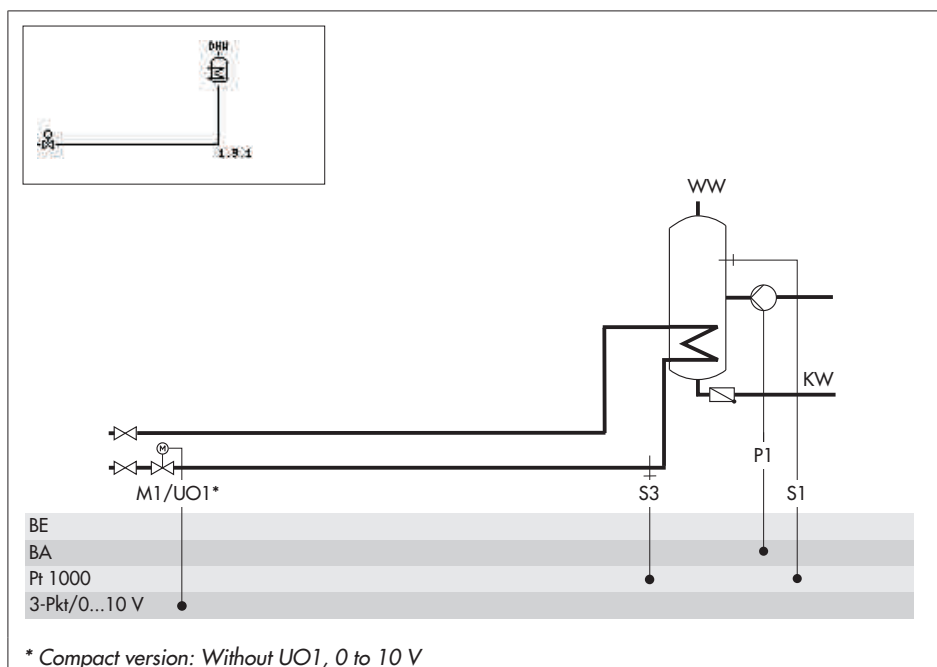

Default settings	
DHW-CO4-03	ON (with S3)

See fold-out page for wiring required for functions.

System An1 2.0.0 (standard version only)

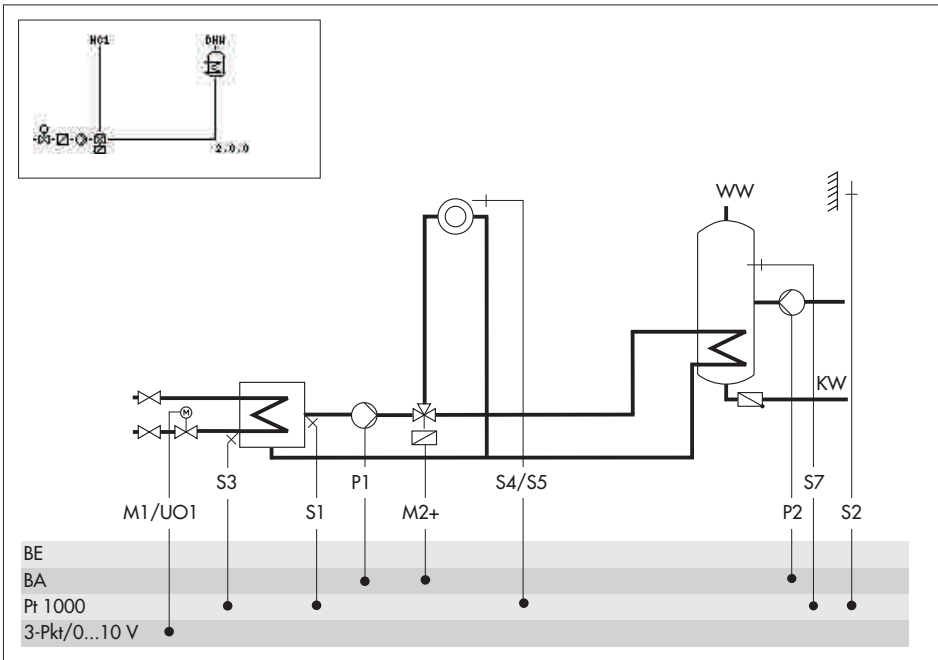

Default settings	
HC1-CO1-01	OFF (without S4/S5)
HC1-CO1-02	ON (with S2)
HC1-CO1-03	ON (with S3)
DHW-CO4-01	ON (with S7)
DHW-CO4-02	OFF (without S8)

See fold-out page for wiring required for functions.

System An1 2.1.0 (standard version only)

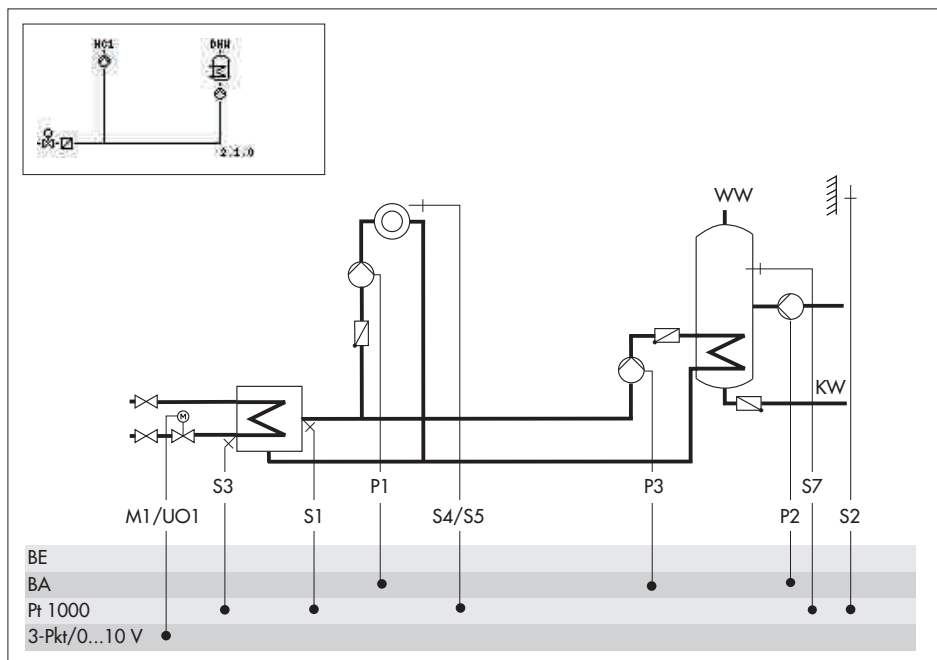
**Default settings**

HC1-CO1-01	OFF	(without S4/S5)
HC1-CO1-02	ON	(with S2)
HC1-CO1-03	ON	(with S3)
DHW-CO4-01	ON	(with S7)
DHW-CO4-02	OFF	(without S8)

See fold-out page for wiring required for functions.

System An1 2.2.0 (standard version only)

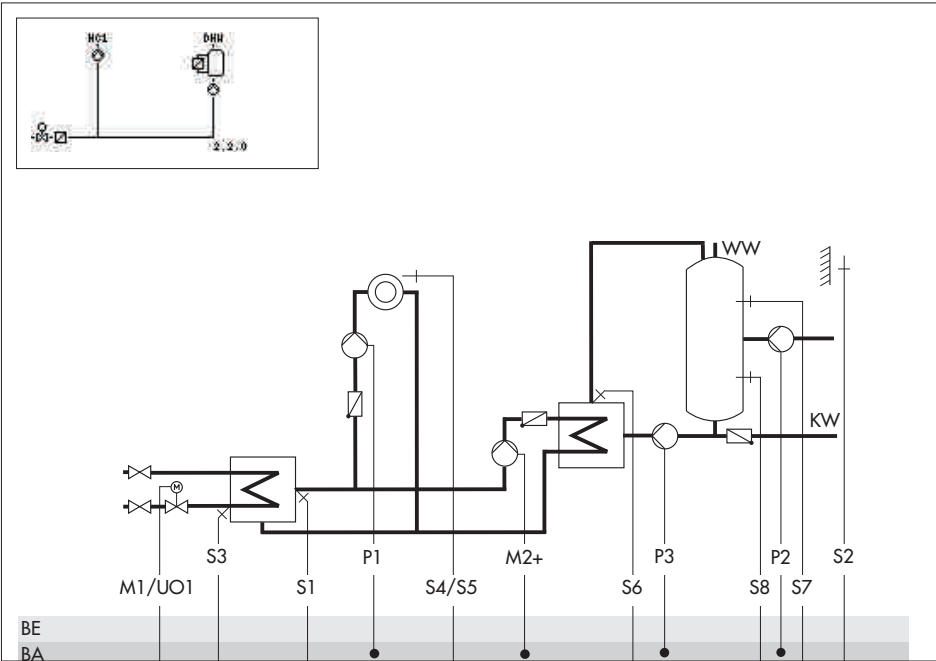

Default settings

HC1-CO1-01	OFF	(without S4/S5)
HC1-CO1-02	ON	(with S2)
HC1-CO1-03	ON	(with S3)
DHW-CO4-01	ON	(with S7)
DHW-CO4-02	ON	(with S8)
DHW-CO4-05	OFF	(without S6)

See fold-out page for wiring required for functions.

System Anl 3.5.0

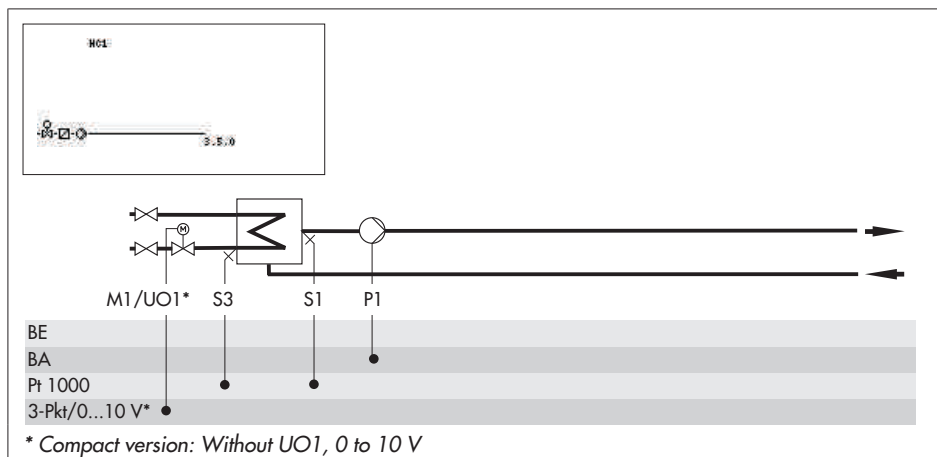

Default settings

HC1-03-03

ON (with S3)

See fold-out page for wiring required for functions.

System An1 11.0.0 (standard version only)

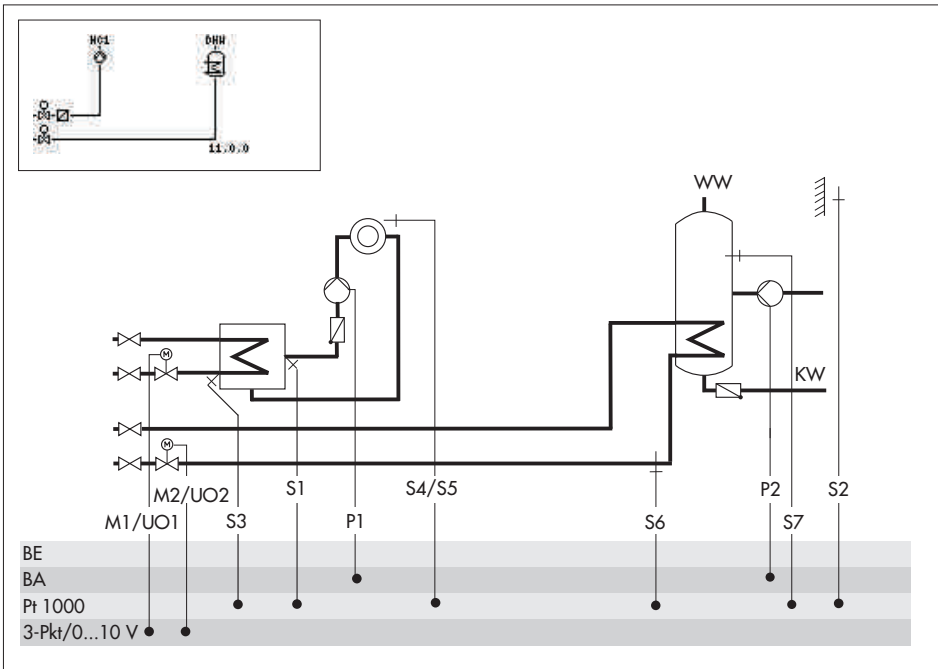

Default settings	
HC1-CO1-01	OFF (without S4/S5)
HC1-CO1-02	ON (with S2)
HC1-CO1-03	ON (with S3)
DHW-CO4-01	ON (with S7)
DHW-CO4-03	ON (with S6)

See fold-out page for wiring required for functions.

System Anl 11.2.0 (standard version only)

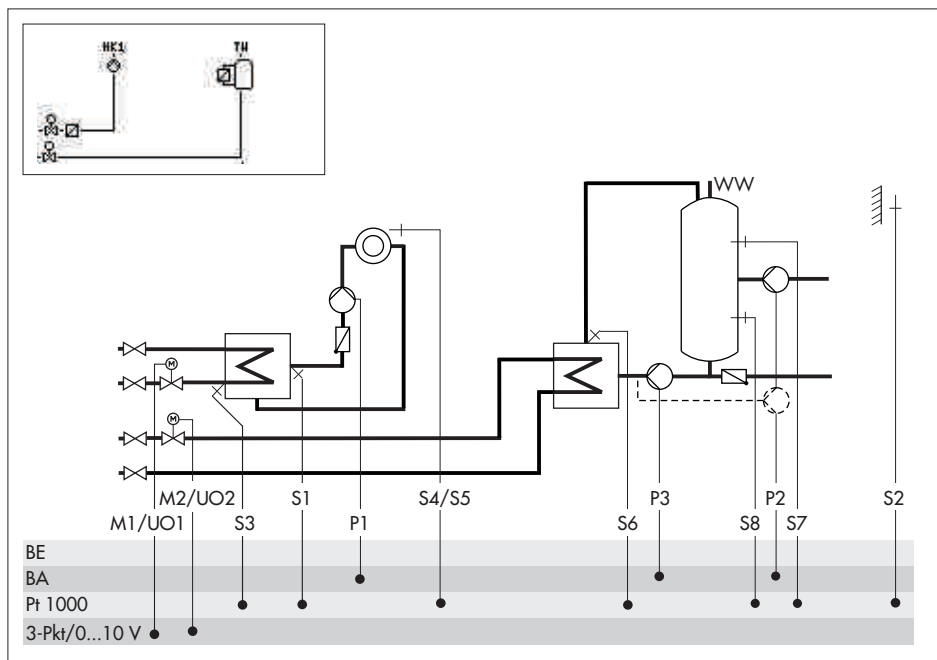

Default settings	
HC1-CO1-01	OFF (without S4/S5)
HC1-CO1-02	ON (with S2)
HC1-CO1-03	ON (with S3)
DHW-CO4-01	ON (with S7)
DHW-CO4-02	ON (with S8)

See fold-out page for wiring required for functions.

System An1 11.9.0 (standard version only)

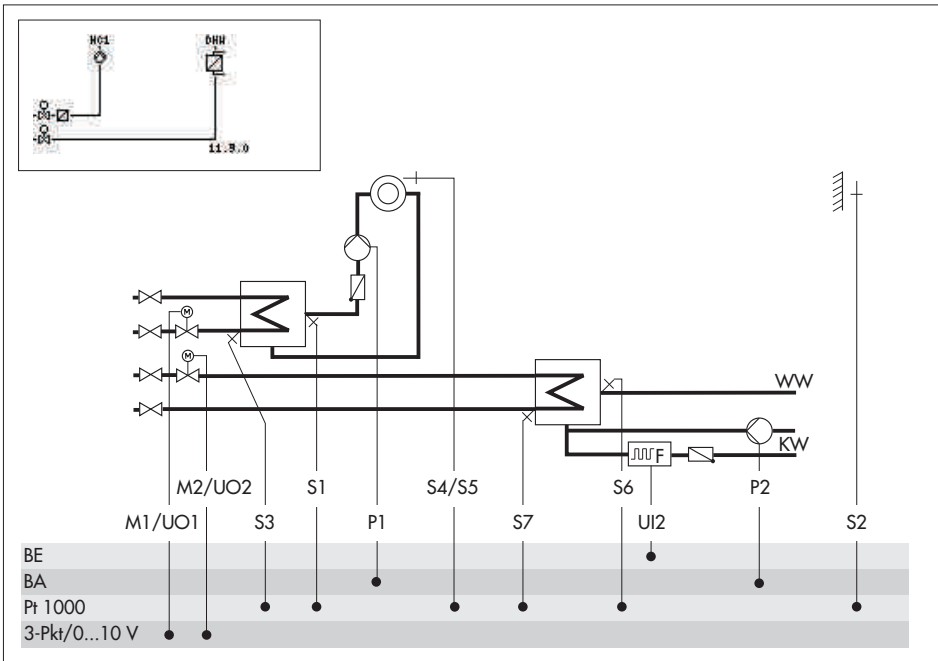

Default settings	
HC1-CO1-01	OFF (without S4/S5)
HC1-CO1-02	ON (with S2)
HC1-CO1-03	ON (with S3)
DHW-CO4-03	ON (with S7)
DHW-CO4-04	OFF (without UI2)

See fold-out page for wiring required for functions.

System Anl 11.9.1 (standard version only)

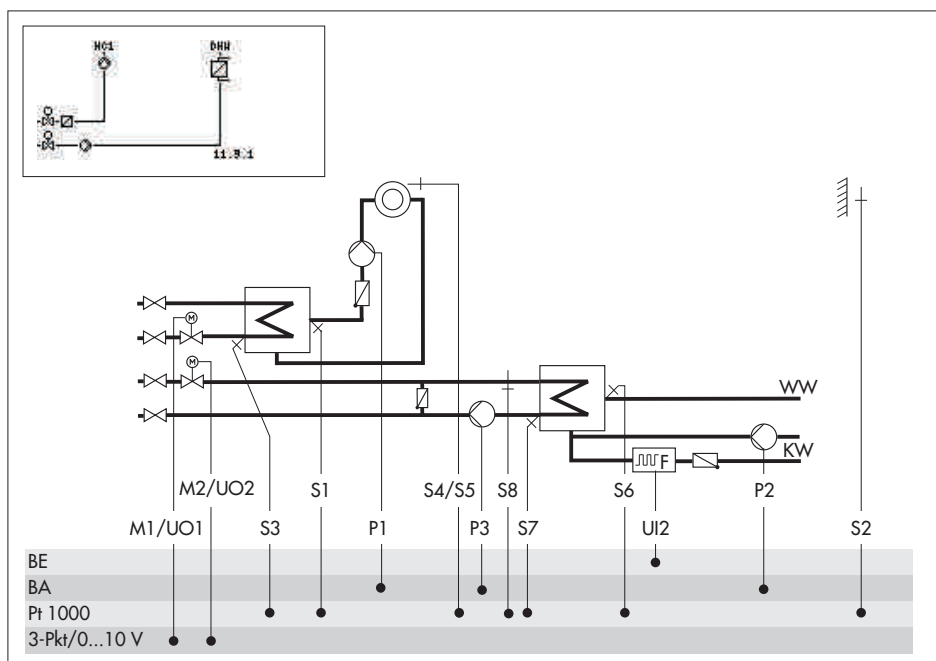
**Default settings**

HC1-CO1-01	OFF	(without S4/S5)
HC1-CO1-02	ON	(with S2)
HC1-CO1-03	ON	(with S3)
DHW-CO4-03	ON	(with S7)
DHW-CO4-04	OFF	(without UI2)
DHW-CO4-05	OFF	(without S6)

See fold-out page for wiring required for functions.

6 Functions of the heating circuit

Which controller functions are available depends on the selected system number (Anl).

6.1 Weather-compensated control

When weather-compensated control is used, the flow temperature is controlled according to the outdoor temperature. The heating characteristic in the controller defines the flow temperature set point as a function of the outdoor temperature (→ Fig. 2). The outdoor temperature required for weather-compensated control can either be measured at an outdoor sensor or received using 0 to 10 V at UI1 input.

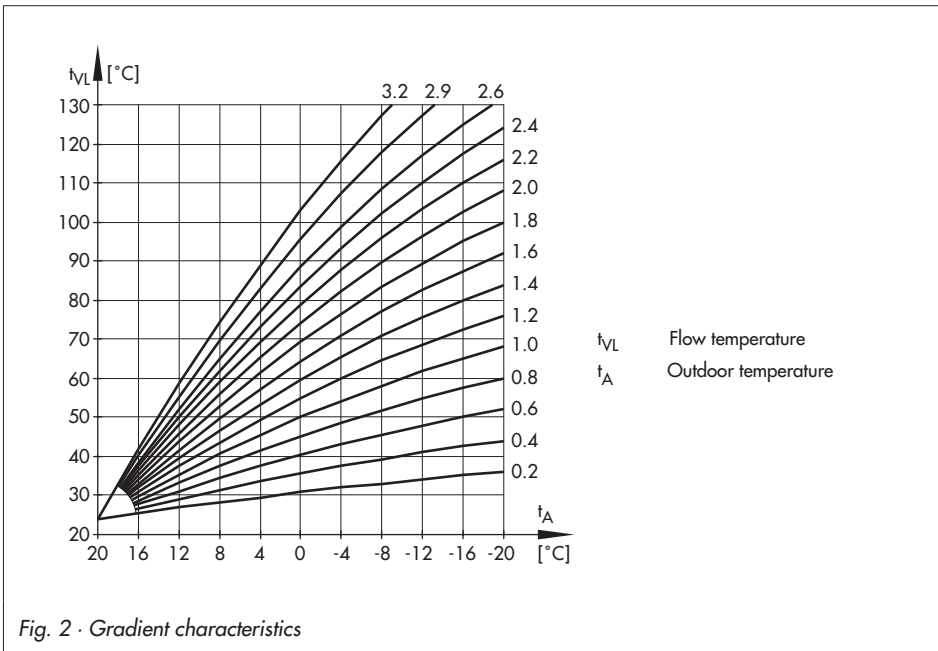

Fig. 2 · Gradient characteristics

Functions	WE	Configuration
Outdoor temperature measurement	ON	HC1-CO1-O2 = ON

Functions	WE	Configuration
Outdoor temperature 0–10 V at UI1	OFF -20.0 °C 50.0 °C	HC1-CO1-04 = ON Lower transmission range value, outdoor temperature/-30.0 to 100.0 °C Lower transmission range value, outdoor temperature/-30.0 to 100.0 °C

6.1.1 Gradient characteristic

Basically, the following rule applies: a decrease in the outdoor temperature causes the flow temperature to increase.

By varying the parameters *Gradient* and *Level*, you can adapt the characteristic to your individual requirements:

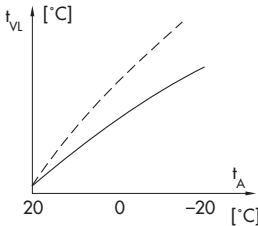

The gradient needs to be increased **if the room temperature drops when it is cold outside.**

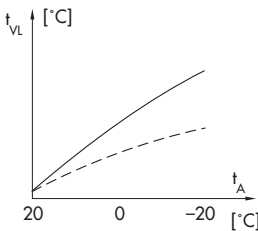

The gradient needs to be decreased **if the room temperature rises when it is cold outside.**

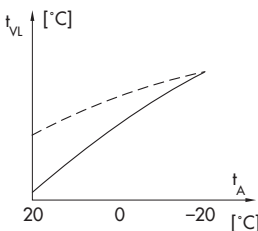

The level needs to be increased and the gradient decreased **if the room temperature drops when it is mild outside.**

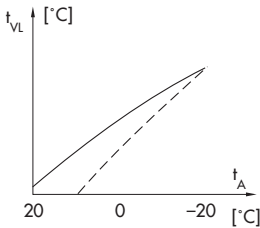

The level needs to be decreased and the gradient increased if the room temperature rises when it is mild outside.

Outside the times-of-use, reduced set points are used for control:

The reduced flow set point is calculated as the difference between the adjusted values for 'HC1 day set point' (rated room temperature) and 'HC1 night set point' (reduced room temperature). For heating systems without room sensor, the reduced flow temperature set point is based on the 'Night set-back, flow' parameter.

The 'Max. flow temperature' and 'Min. flow temperature' parameters mark the upper and lower limits of the flow temperature. A separate gradient characteristic can be selected for the limitation of the return flow temperature.

Examples for adjusting the characteristic:

- ▶ Old building, radiator design 90/70: Gradient approx. 1.8
- ▶ New building, radiator design 70/55: Gradient approx. 1.4
- ▶ New building, radiator design 55/45: Gradient approx. 1.0
- ▶ Underfloor heating depending on arrangement: Gradient smaller than 0.5

Note: For heating systems with room sensor and without configured influence of the room temperature on the control process, the room temperature settings for day (HC1 day set point) and for night (HC1 night set point) only become effective satisfactorily when the heating characteristic has been adapted to the building/heating surface layout.

Functions	WE	Configuration
Four-point characteristic	OFF	HC1-CO1-11 = OFF
Parameters	WE	Parameter settings
Flow gradient	1.4	HC1-PA1-01 / 0.2 to 3.2
Flow level	0.0 °C	HC1-PA1-02 / -30.0 to 30.0 °C
Min. flow temperature	20.0 °C	HC1-PA1-06 / 5.0 to 130.0 °C
Max. flow temperature	90.0 °C	HC1-PA1-07 / 5.0 to 130.0 °C
Night set-back, flow	10.0 K	HC1-PA1-08 / 0.0 to 50.0 K

Parameters	WE	Parameter settings
HC1 day set point		
HC1 night set point		Refer to section 3.1

6.1.2 Four-point characteristic

The four-point characteristic allows you to define your own heating characteristic. It is defined by four points for 'Outdoor temperature', 'Flow temperature', 'Reduced flow temperature' and 'Return flow temperature'. The 'Max. flow temperature' and 'Min. flow temperature' parameters mark the upper and lower limits of the flow temperature.

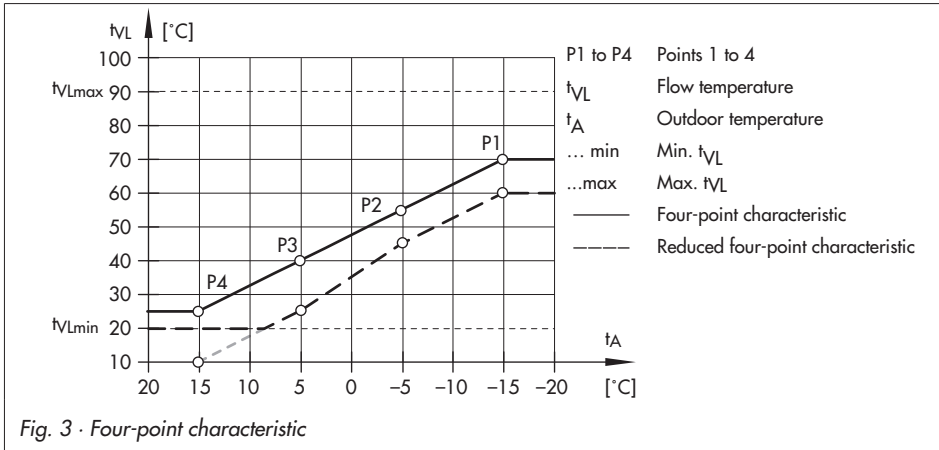





Fig. 3 · Four-point characteristic

Note:

- The HC1 flow temperature set points can be raised or reduced by 2 K in four stages even when the four-point characteristic is selected. The room temperature set points for day and night must be set (→ Section 3.1) if the supplementary functions, such as **Optimization** or **Flash adaptation** (the room temperature must be measured for both these functions), are configured.
- The **four-point characteristic** function can only be activated when the **Adaptation** function is not active.

Functions	WE	Configuration
Adaptation	OFF	HC1-CO1-10 = OFF
Four-point characteristic	OFF	HC1-CO1-11 = ON

Parameters		WE	Parameter settings
Outdoor temperature	Point 1	-15.0 °C	HC1-PA1-05  / -30.0 to 50.0 °C
	Point 2	-5.0 °C	
	Point 3	5.0 °C	
	Point 4	15.0 °C	
Flow temperature	Point 1	70.0 °C	HC1-PA1-05  / 5.0 to 130.0 °C
	Point 2	55.0 °C	
	Point 3	40.0 °C	
	Point 4	25.0 °C	
Reduced flow temperature	Point 1	60.0 °C	HC1-PA1-05  / 5.0 to 130.0 °C
	Point 2	40.0 °C	
	Point 3	20.0 °C	
	Point 4	20.0 °C	
Return flow temperature	Point 1	65.0 °C	HC1-PA1-05  / 5.0 to 90.0 °C
	Point 2	65.0 °C	
	Point 3	65.0 °C	
	Point 4	65.0 °C	

6.2 Fixed set point control

During the times-of-use, the flow temperature can be controlled according to a fixed set point. Outside the times-of-use, the controller regulates to a reduced flow temperature. For this function the rated flow temperature is set in 'Day set point' and the reduced flow temperature in 'Night set point'.

Function	WE	Configuration
Outdoor temperature measurement	ON	HC1-CO1-02 = OFF
Parameters	WE	Parameter settings
Min. flow temperature	20.0 °C	HC1-PA1-06 / 5.0 to 130.0 °C
Max. flow temperature	90.0 °C	HC1-PA1-07 / 5.0 to 130.0 °C
HC1 day set point		
HC1 night set point		Refer to section 3.1

6.3 Underfloor heating/drying of jointless floors

Underfloor heating

The function block setting HC1-CO1-05 = ON defines heating circuit HC1 as an underfloor heating circuit. This causes the controller at first to only restrict the value ranges for the heating characteristic gradient and the maximum flow temperature in parameter level PA1:

- ▶ Flow gradient (HC1-PA1-01): 0.2 to 1.0
- ▶ Max. flow temperature (HC1-PA1-07): 5.0 to 50.0 °C

Drying of jointless floors

The function block parameters are required for the **drying of jointless floors**. They determine the drying process: the first heating up phase starts at the entered 'Start temperature for drying of jointless floors', which has a flow temperature of 25 °C in its default setting. In the course of 24 hours, this temperature is raised by the value entered in 'Temperature increase for drying of jointless floors' i.e. the default setting causes the flow temperature set point to rise to 30 °C. If the 'Max. temperature for drying of jointless floors' is reached, it is kept constant for the number of days entered in 'Max. temperature sustaining time for drying of jointless floors'. 'Temperature reduction for drying of jointless floors' determines the temperature reduction downwards. When temperature reduction is set to 0, the temperature maintaining phase moves directly to the automatic mode. By setting 'Start drying of jointless floors' to '1', the drying of jointless floors function is started. The restarting points 2 and 3 can be selected to continue an interrupted drying process.

The drying process has been completed when the 'Start drying of jointless floors' parameter adopts the value '4'.

The value '0' indicates a deviation of the flow temperature by more than 5.0 °C lasting more than 30 minutes. The controller cancels the function in such cases. While the '0' signal is active, the controller regulates the flow temperature to 25.0 °C. If the power supply is interrupted while the drying process is running or when the '0' signal is active, the drying process is automatically restarted.

The value '5' indicates that the controller has canceled the drying function.

In systems in which the drying function had to be interrupted due to DHW heating (e.g. system Anl 2.0.0), storage tank charging does not occur while the drying function is active, provided it is not used for frost protection of the storage tank.

NOTICE

The function block parameters can only be accessed when the function has started by deactivating the function block and activating it again.

Function	WE	Configuration
Underfloor heating	OFF	HC1-CO1-05 = ON
	25.0 °C	Start temperature for drying of jointless floors / 20.0 to 60.0 °C
	5.0 °C/day	Temperature increase for drying of jointless floors / 1.0 to 10.0 °C/day
	45.0 °C	Max. temperature for drying of jointless floors / 2.0 to 60.0 °C
	4 days	Max. temperature sustaining time for drying of jointless floors / 1 to 10 days
	0.0 °C/day	Temperature reduction for drying of jointless floors / 0.0 to 10.0 °C/day
	0	Start drying of jointless floors / 0 to 5

6.4 Deactivation based on the outdoor temperature

6.4.1 HC deactivation value (day)

If the outdoor temperature exceeds 'HC1 deactivation value (day)', the heating circuit is immediately deactivated. The valve is closed and the pump is switched off after $t = 2 \times$ valve transit time. When the outdoor temperature falls below this value (less 0.5 °C hysteresis), heating operation is restarted immediately.

The default setting causes the system to be deactivated during the warm season when the outdoor temperature reaches 22.0 °C.

Parameter	WE	Parameter settings
HC1 deactivation value (day)	22.0 °C	Refer to section 3.1

6.4.2 HC deactivation value (night)

If the outdoor temperature exceeds 'HC1 deactivation value (night)' outside the times-of-use, the heating circuit is immediately deactivated. The valve is closed and the pump is switched off after $t = 2 \times$ valve transit time. When the outdoor temperature falls below this value (less 0.5 °C hysteresis), heating operation is restarted immediately.

The default setting causes the system to be deactivated when the outdoor temperature reaches 15.0 °C at night to save energy. However, it is important to remember that the system requires some time in the morning to heat up the building.

Parameter	WE	Parameter settings
HC1 deactivation value (night)	15.0 °C	Refer to section 3.1

6.4.3 Outdoor temperature for continuous rated operation (day)

If a heating circuit is in reduced operation (automatic mode), the circuit is automatically switched to rated operation (day mode) when the outdoor temperature falls below 'Outdoor temperature for continuous rated operation (day)'. When the limit value is exceeded (plus 0.5 °C hysteresis), reduced operation is restarted.

This function is activated at very low temperatures to avoid the building cooling down excessively outside the times-of-use when outdoor temperatures are low.

Parameter	WE	Parameter settings
Outdoor temperature for continuous rated operation (day)	-15.0 °C	HC1-PA1-09 / -20.0 to 5.0 °C

6.4.4 Summer mode

Summer mode is activated depending on the mean daytime temperature (measured between 7.00 h and 22.00 h) during the desired period ('Earliest start date for summer mode' to 'Latest stop date for summer mode').

If the mean daytime temperature exceeds the limit entered in 'Outdoor temperature for summer mode' on the number of successive days determined in 'Delay of summer mode active' parameter, summer mode is activated on the following day: the valves of all heating circuits are closed and the heating pumps are switched off after $t = 2 \times$ valve transit time.

If the mean daytime temperature remains below the limit entered in 'Outdoor temperature for summer mode' on the number of successive days determined in 'Delay of heating mode active', summer mode is deactivated on the following day.

Function	WE	Configuration
Summer mode	OFF	HC1-CO5-04 = ON
	01.06	Earliest start date for summer mode / User-definable
	2 days	Delay of summer mode active / 1 to 3 days
	30.09	Latest stop date for summer mode / User-definable
	1 day	Delay of heating mode active / 1 to 3 days
	18.0 °C	Outdoor temperature for summer mode / 0.0 to 30.0 °C

Note: Summer mode only becomes effective when the controller is in automatic mode.

6.5 Delayed outdoor temperature adaptation

The calculated outdoor temperature is used to determine the flow temperature set point. The heat response is delayed when the outdoor temperature either decreases, increases or increases and decreases. If the outdoor temperature varies by, for example, 12 °C within a very short period of time, the calculated outdoor temperature is adapted to the actual outdoor temperature in small steps. Assuming a delay of 3 °C/h, the adaptation would take $t = \frac{12\text{ °C}}{3\text{ °C/h}} = 4\text{ h}$.

Note: The delayed outdoor temperature adaptation helps avoid unnecessary overloads of central heating stations in combination with either overheated buildings occurring, for example, due to warm winds, or temporarily insufficient heating due to the outdoor sensor being exposed to direct sunshine.

Functions	WE	Configuration
Delay decreasing outdoor temperature	OFF 3.0 °C/h	HC1-CO5-05 = ON Outdoor temperature delay / 1.0 to 6.0 °C/h
Delay increasing outdoor temperature	OFF 3.0 °C/h	HC1-CO5-06 = ON Outdoor temperature delay / 1.0 to 6.0 °C/h

Note: The 'Outdoor temperature delay' setting applies to both function blocks HC1-CO5-05 and HC1-CO5-06!

6.6 Remote operation

Besides measuring the room temperature, the Type 5257-5 Room Panel (Pt 1000, refer to Section 11 for electrical connection) offers the following options to influence the control process:

- ▶ Selection of the operating mode:
 - Automatic mode
 - Day mode
 - Night mode
- ▶ Set point correction: during rated operation (day mode), the room temperature set point can be increased or reduced by up to 5 °C or by up to 8 °C when the four-point characteristic function is selected at the continuously adjustable rotary knob

When the room sensor is activated, the measured room temperature is displayed when the remote operation is connected and activated. However, it is not used for control unless the **Optimization based on room temperature** or **Flash adaptation** functions have been activated.

Functions	WE	Configuration
Room temperature measurement	OFF	HC1-CO1-01 = ON

Functions	WE	Configuration
Optimization based on room temperature	OFF	HC1-CO1-07 = OFF
Optimization based on outdoor and room temperature	OFF	HC1-CO1-08 = OFF
Flash adaptation	OFF	HC1-CO1-09 = OFF

6.7 Optimization

6.7.1 Optimization based on outdoor temperature

This function requires the use of an outdoor sensor.

The controller activates the heating based on the outdoor temperature before the time-of-use in day mode. The 'Preheating time' is based on an outdoor temperature of $-12\text{ }^{\circ}\text{C}$. This preheating time is shortened when the outdoor temperature is higher.

The colder it is outside, the earlier the night set-back finishes to ensure that the selected 'HC1 day set point' is reached as close as possible to the time when the time-of-use starts.

Functions	WE	Configuration
Outdoor temperature measurement	ON	HC1-CO1-02 = ON
Optimization based on outdoor temperature	OFF	HC1-CO1-06 = ON
	120 min	Preheating time / 0 to 360 min
Parameter	WE	Parameter settings
HC1 day set point		Refer to section 3.1

6.7.2 Optimization based on room temperature

This function requires the use of a room sensor. The room in which the room sensor is located (reference room) should have a similar heating characteristic to the rest of the building. In addition, this reference room must not have any radiators with thermostatic valves.

Depending on the building characteristics, the controller determines and adapts the required preheating time (maximum 8 hours) to ensure that the desired 'HC1 day set point' (rated room temperature) has been reached in the reference room when the time-of-use starts. This temperature is built up in steps of $10\text{ }^{\circ}\text{C}$. As soon as the 'HC1 day set point' has been reached, weather-compensated control is activated. Depending on the room sensors, the controller switches off the heating system up to one hour before the time-of-use ends. The controller

chooses the deactivation time such that the room temperature does not drop significantly below the desired value before the time-of-use ends.

Outside the times-of-use, the controller monitors the 'HC1 night set point' (reduced room temperature). When the temperature falls below the night set point, the controller heats with the max. flow temperature until the measured room temperature exceeds the adjusted value by 1 °C.

Note:

- *Direct sunshine can cause the room temperature to increase and thus result in the premature deactivation of the heating system.*
- *When the room temperature decreases while the heating system is temporarily outside its times-of-use, this can prematurely cause the controller to heat up to the 'HC1 day set point'.*

Functions	WE	Configuration
Room temperature measurement	OFF	HC1-CO1-01 = ON
Optimization based on room temperature	OFF	HC1-CO1-07 = ON
Parameter	WE	Parameter settings
HC1 day set point		
HC1 night set point	Refer to section 3.1	

6.7.3 Optimization based on outdoor and room temperature

This function requires the use of an outdoor sensor and a room sensor. The room in which the room sensor is located (reference room) should have a similar heating characteristic to the rest of the building. In addition, this reference room must not have any radiators with thermostatic valves.

The controller activates the heating based on the outdoor temperature before the time-of-use in day mode. The 'Preheating time' is based on an outdoor temperature of -12 °C. This preheating time is shortened when the outdoor temperature is higher (see section 6.7.1). Depending on the room sensor, the controller switches off the heating system up to one hour before the time-of-use ends. The controller chooses the deactivation time such that the room temperature does not drop significantly below the desired value before the time-of-use ends.

Outside the times-of-use, the controller monitors the 'HC1 night set point' (reduced room temperature). When the temperature falls below the night set point, the controller heats with the

max. flow temperature until the measured room temperature exceeds the adjusted value by 1 °C.

Note:

- Direct sunshine can cause the room temperature to increase and thus result in the premature deactivation of the heating system.
 - When the room temperature decreases while the heating system is temporarily outside its times-of-use, this can prematurely cause the controller to heat up to the 'HC1 day set point'.
-

Functions	WE	Configuration
Room temperature measurement	OFF	HC1-CO1-01 = ON
Outdoor temperature measurement	ON	HC1-CO1-02 = ON
Optimization based on outdoor and room temperature	OFF 120 min	HC1-CO1-08 = ON Preheating time / 0 to 360 min
Parameters	WE	Parameter settings
HC1 day set point		
HC1 night set point		Refer to section 3.1

6.8 Flash adaptation

To ensure that the controller reacts immediately to room temperature deviations during day or night mode, the function block setting HC1-CO1-09 = ON must be made. The heating is then always switched off as soon as the room temperature exceeds 'HC1 day set point' or 'HC1 night set point' by 2 °C.

Heating first starts again when the room has cooled off and the room temperature is 1 °C above the set point. The flow temperature set point is corrected if the settings for 'Cycle time' and 'Gain' are not set to 0. The 'Cycle time' determines the intervals at which the flow temperature set point is corrected by 1 °C. 'Gain' set to a value other than 0 causes a direct increase/decrease in flow temperature set point when a sudden deviation in room temperature arises. We recommend setting 'Gain' to 10.0.

Note:

- Cooling loads, such as drafts or open windows, affect the control process!
 - Rooms may be temporarily overheated after the cooling load has been eliminated!
-

Functions	WE	Configuration
Flash adaptation	OFF	HC1-CO1-09 = ON
	20 min	Cycle time / 0 to 100 min
	0.0	Gain / 0.0 to 25.0

6.8.1 Flash adaptation without outdoor sensor (based on room temperature)

The flow temperature control starts with 'Flow set point (day)' in day mode or with 'Flow set point (night)' in night mode as no set points calculated using characteristics exist without an outdoor sensor. The 'Cycle time' determines the intervals at which the flow temperature set point is corrected by 1 °C. The heating is then always switched off as soon as the room temperature exceeds the 'HC1 day set point' or 'HC1 night set point' by 2.0 °C. Heating first starts again when the room has cooled off and the room temperature is 1 °C above the set point. 'Gain' set to a value other than 0 causes a direct increase/decrease in flow temperature set point when a sudden deviation in room temperature arises. We recommend setting 'Gain' to 10.0.

Functions	WE	Configuration
Room temperature measurement	OFF	HC1-CO1-01 = ON
Outdoor temperature measurement	ON	HC1-CO1-02 = OFF
Flash adaptation	OFF	HC1-CO1-09 = ON
	20 min	Cycle time / 0 to 100 min
	0.0	Gain / 0.0 to 25.0

Parameters	WE	Parameter settings
Flow set point (day)	50.0 °C	HC1-PA1-03 / 5.0 to 130.0 °C
Flow set point (night)	30.0 °C	HC1-PA1-04 / 5.0 to 130.0 °C

HC1 day set point	Refer to section 3.1
HC1 night set point	

6.9 Adaptation

The controller is capable of automatically adapting the heating characteristic to the building characteristics, provided a gradient characteristic has been set (HC1-CO1-11 = OFF). The reference room, where the room sensor is located, represents the entire building and is monitored to ensure that the room set point ('HC1 day set point') is maintained. When the measured mean room temperature in day mode deviates from the adjusted set point, the heating characteristic is modified accordingly for the next time-of-use.

Functions of the heating circuit

Functions	WE	Configuration
Room temperature measurement	OFF	HC1-CO1-01 = ON
Outdoor temperature measurement	ON	HC1-CO1-02 = ON
Adaptation	OFF	HC1-CO1-10 = ON
Four-point characteristic	OFF	HC1-CO1-10 = OFF
Parameter	WE	Parameter settings
HC1 day set point	Refer to section 3.1	

Note: If the **Flash adaptation** function is already configured with a small cycle time, the **Adaptation** function should not be configured as well.

6.10 Set point correction using a 0 to 10 V signal

The HC1 set points can be corrected in a linear manner within the range between $-8\text{ }^{\circ}\text{C}$ (potentiometer input 1 V) to $+8\text{ }^{\circ}\text{C}$ (potentiometer input 9 V). Signals lower than 1 V or greater than 9 V do not have any effect on the HC1 set points.

Note: The connection of the set point correction using a 0 to 10 V signal (HC1-CO1-15 = ON) depends on the system selected. Refer to fold-out page.

Function	WE	Configuration
Set point correction using 0 to 10 V	OFF	HC1-CO1-15 = ON

7 Functions of the DHW circuit

7.1 DHW heating in the storage tank system

Start storage tank charging

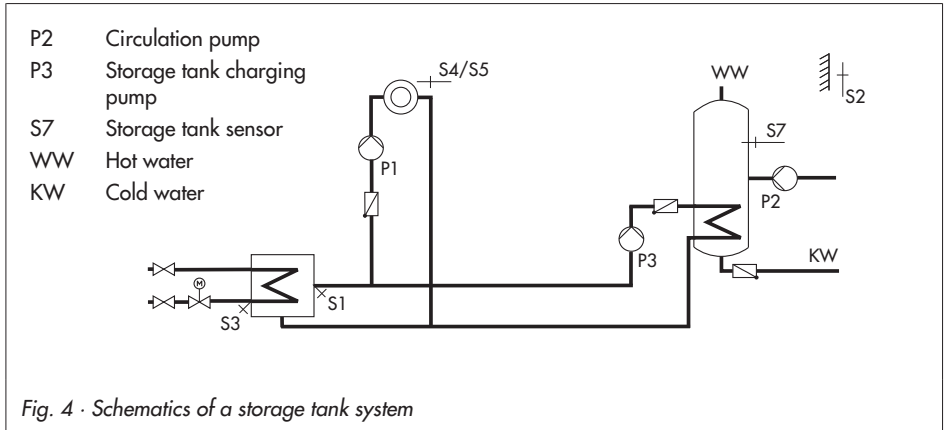

The controller begins charging the storage tank when the water temperature measured at sensor S7 falls below 'DHW day set point' by 0.1 °C. When no heating operation takes place, the storage tank charging pump P3 is switched on immediately.

If the flow temperature in the system is higher than the desired charging temperature (= 'DHW day set point' + 'Charging temperature boost'), the controller tries to reduce the flow temperature in the heating circuit for up to five minutes before the storage tank charging pump P3 is activated.

If the flow temperature in the system is lower than the desired charging temperature, the controller tries to build up the flow temperature in the heating circuit for up to five minutes before the storage tank charging pump P3 is activated.

If the function DHW-CO4-16 = ON (**SLP not ON unless return flow hot**) is activated, the primary valve is opened without simultaneously operating the storage tank charging pump P3. The storage tank charging pump P3 is not switched on before the primary return flow temperature has reached the temperature currently measured at storage tank sensor S7. This function enables storage tank charging when the heating system is switched off, e.g. in summer mode, without cooling down the storage tank first by filling it with cold flow water.

Note: The storage tank charging temperatures are adjusted instead of the storage tank temperatures in the menu item for DHW set points when a storage tank thermostat is used.

Time-controlled switchover of storage tank sensors

By configuring a second storage tank sensor S8 over the function block DHW-CO4-19 = ON, it is possible to determine that the storage tank sensor S7 is used for day mode in the DHW circuit and that the storage tank sensor S8 is used for night mode. As a result, different storage tank volumes can be kept at a constant temperature according to a time schedule, and also at different temperatures if the 'DHW day set point' and 'DHW night set point' differ from one another.

Stop storage tank charging

The controller stops charging the storage tank when the water temperature measured at sensor S7 has reached the temperature $T = \text{'DHW day set point'} + \text{'Hysteresis'}$. When there is no heating operation or when the flow temperature demand in the system is lower, the corresponding valve is closed. The storage tank charging pump P3 is switched off after 'Lag time for storage tank charging pump' has elapsed.

The default settings cause the temperature in the storage tank is to increase by 5 °C to reach 60 °C when the storage tank temperature falls below 55 °C. The charging temperature is calculated from the 'DHW day set point' (55.0 °C) plus 'Charging temperature boost' (10.0 °C), which equals 65 °C. When the storage tank has been charged, the heating valve is closed and the charging pump continues to run for the time entered in 'Lag time for storage tank charging pump'. Outside the times-of-use, the storage tank is only charged when the temperature falls below 'DHW night set point' (40.0 °C). In this case, the tank is charged with a charging temperature of 50 °C until 45 °C are reached in the tank.

Functions	WE	Configuration
Storage tank sensor S7	OFF	DHW-CO4-01 = ON
Primary valve opened without operation of the storage tank charging pump:		
SLP not ON unless return flow hot	OFF	DHW-CO4-16 = ON
Time-controlled switchover of storage tank sensors:		
Storage tank sensor S8 (bottom)		DHW-CO4-02 = ON
Scheduled switchover between S7 and S8	OFF	DHW-CO4-19 = ON
Parameters		
Min. adjustable DHW set point	40.0 °C	DHW-PA4-01 / 5.0 to 90.0 °C

Parameters	WE	Parameter settings
Max. adjustable DHW set point	60.0 °C	DHW-PA4-02 / 5.0 to 90.0 °C
Hysteresis	5.0 °C	DHW-PA4-03 / 1.0 to 30.0 °C
Charging temperature boost	10.0 °C	DHW-PA4-04 / 0.0 to 50.0 °C
Max. charging temperature	80.0 °C	DHW-PA4-05 / 20.0 to 130.0 °C
Lag time for storage tank charging pump	90 s	DHW-PA4-06 / 0 to 600 s
DHW day set point	55.0 °C	Refer to section 3.1
DHW night set point	40.0 °C	

7.2 DHW heating in the storage tank charging system

Start storage tank charging

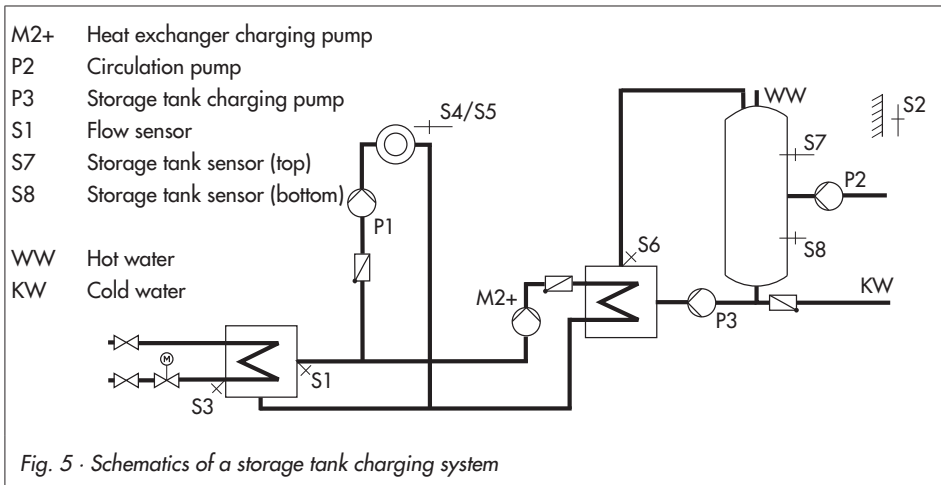

The controller begins charging the storage tank when the water temperature measured at sensor S7 falls below the 'DHW day set point' by 0.1 °C. If the flow temperature in the system is higher than the desired charging temperature (= 'DHW day set point' + 'Charging temperature boost'), the controller tries to reduce the flow temperature in the heating circuit for up to five minutes before the heat exchanger charging pump M2+ is activated together with the storage tank charging pump P3.

When there is no heating operation or when the flow temperature in the system is lower, the heat exchanger charging pump M2+ is switched on immediately. If the temperature currently measured at storage tank sensor S7 is reached at the flow sensor S1, or after five minutes at the

latest, the storage tank charging pump P3 is switched on.

If a storage tank thermostat is used, the storage tank charging pump P3 is switched on when the temperature $T = \text{Charging temperature} - 5\text{ °C}$ is reached at the flow sensor S1.

Note: *The storage tank charging temperatures are adjusted instead of the storage tank temperatures in the menu item for DHW set points when a storage tank thermostat is used.*

When the flow sensor S6 is activated, the set point in the heat exchanger circuit is influenced by the system deviation in the storage tank charging circuit upon activation of the storage tank charging pump P3: if the temperature measured at flow sensor S6 is lower than the desired charging temperature, the set point in the heat exchanger circuit is increased in steps of 1 °C.

When the set point in the heat exchanger charging circuit reaches the 'Max. charging temperature', the set point is no longer increased. An error message 'Max. charging temperature reached' is generated.

Note: *The set point in the heat exchanger circuit which is valid at the end of the charging cycle will be used again at the beginning of the next cycle.*

If times-of-use have been set for DHW heating, 'DHW day set point' applies during these times-of-use.

Outside the times-of-use, the 'DHW night set point' is used. This does not apply when a storage tank thermostat is used.

Time-controlled switchover of storage tank sensors

The function block setting DHW-CO4-19 = ON determines that the storage tank sensor S7 is used for day mode in the DHW circuit and that the storage tank sensor S8 is used for night mode. As a result, different storage tank volumes can be kept at a constant temperature according to a time schedule, and also at different temperatures if the 'DHW day set point' and 'DHW night set point' differ from one another.

Stop storage tank charging

The controller stops charging the storage tank when the water temperature measured at sensor S8 has reached the temperature $T = \text{'DHW day set point'} + \text{'Hysteresis'}$. To avoid accumulated heat, the heat exchanger charging pump continues to run for the time entered in 'Lag time for storage tank charging pump' when the valve closes. The storage tank charging pump P3 is switched off approx. ten seconds after the lag time of the heat exchanger charging pump.

Functions	WE	Configuration
Storage tank sensor S7	OFF	DHW-CO4-01 = ON
Storage tank sensor S8 (bottom)	OFF	DHW-CO4-02 = ON
Active flow sensor DHW:		
Flow sensor DHW	OFF	DHW-CO4-05 = ON
Time-controlled switchover of storage tank sensors:		
Scheduled switchover between S7 and S8	OFF	DHW-CO4-19 = ON

Parameters	WE	Parameter settings
Min. adjustable DHW set point	40.0 °C	DHW-PA4-01 / 5.0 to 90.0 °C
Max. adjustable DHW set point	60.0 °C	DHW-PA4-02 / 5.0 to 90.0 °C
Hysteresis	5.0 °C	DHW-PA4-03 / 1.0 to 30.0 °C
Charging temperature boost	10.0 °C	DHW-PA4-04 / 0.0 to 50.0 °C
Max. charging temperature	80.0 °C	DHW-PA4-05 / 20.0 to 130.0 °C
Lag time for storage tank charging pump	90 s	DHW-PA4-06 / 0 bis 600 s
DHW day set point	55.0 °C	Refer to section 3.1
DHW night set point	40.0 °C	

7.2.1 Circulation return flow in heat exchanger

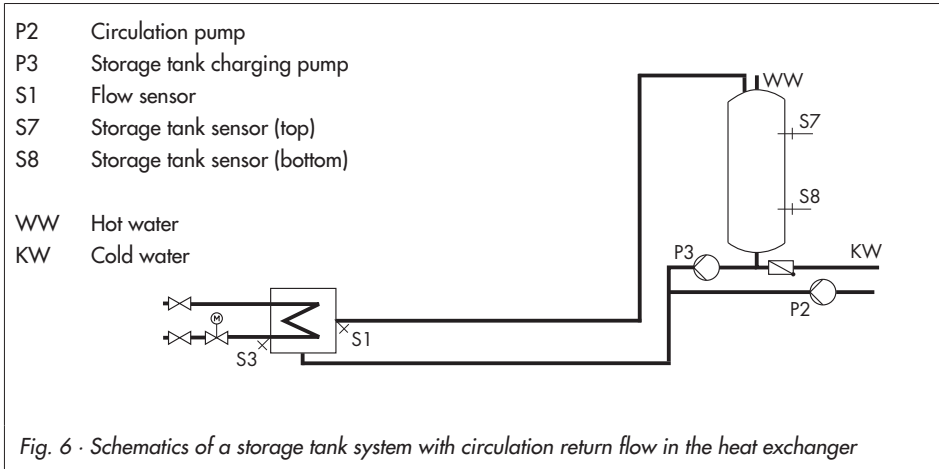

When the **Circulation return flow in heat exchanger** function is active, the control process using the 'DHW day set point' remains active according to the time schedule even when the temperature $T = \text{'DHW day set point'} + \text{'Hysteresis'}$ has been exceeded at storage tank sensor S8. In this way, circulation losses (even for small amounts of tapped hot water) are compensated for over the heat exchanger.

Functions	WE	Configuration
Circulation return flow in heat exchanger	OFF	DHW-CO4-10 = ON

7.3 DHW heating in instantaneous heating system

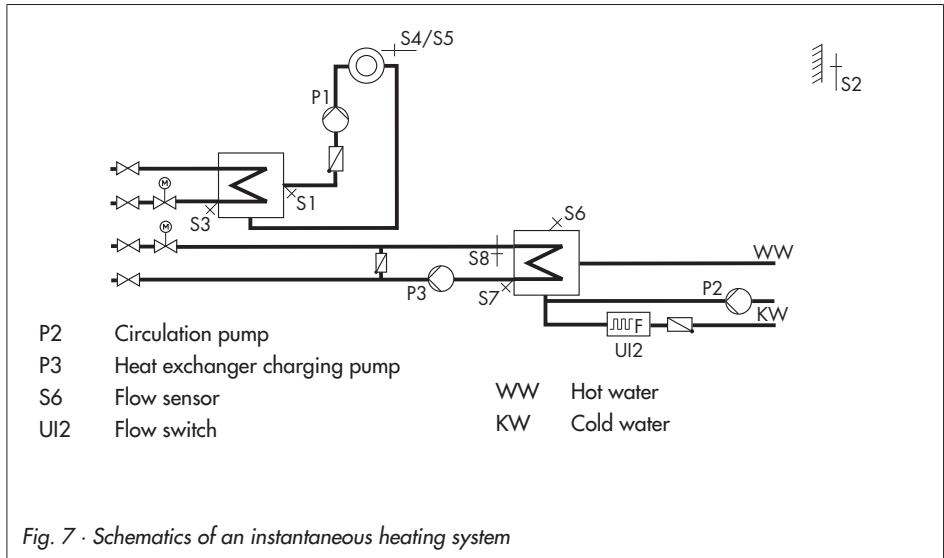

The instantaneous DHW heating system can be configured in systems Anl 1.9.0, 11.9.0 and 11.9.1.

Without a flow switch, the controller can only regulate the DHW temperature to 'Day DWH set point' during the times-of-use of the circulation pump. The flow switch allows the controller to recognize exactly when DHW is being tapped. By deleting all the time-of-uses for the circulation pump P2, it is possible to regulate the DHW temperature to 'Day DWH set point' just while the DHW is being tapping.

When the tapping is finished, the valve closes and the heat exchanger charging pump P1 is switched off after a delay.

Function	WE	Configuration
Flor rate recognition	OFF	DHW-CO4-04 = ON
Parameter	WE	Parameter settings
Min. adjustable DHW set point	40.0 °C	DHW-PA4-01 / 5.0 to 90.0 °C
Max. adjustable DHW set point	60.0 °C	DHW-PA4-02 / 5.0 to 90.0 °C

Parameter	WE	Parameter settings
Night DWH set point	40.0 °C	Refer to section 3.1
Day DWH set point	55.0 °C	

7.4 Intermediate heating operation

This function can only be activated in systems AnI 2.0.0, 2.1.0 and 2.2.0.

The function block setting DHW-CO4-07 = ON causes heating operating in heating circuit HC1 to be restarted for ten minutes after 20 minutes priority. The setting DHW-CO4-07 = OFF gives the storage tank charging unlimited priority over the heating operation in the UP1 heating circuit.

Note: The **Intermediate heating** and **Parallel pump operation** functions cannot be configured simultaneously. When DHW-CO4-06 = ON is configured, DHW-CO4-07 = ON cannot be selected and vice versa.

Functions	WE	Configuration
Intermediate heating	ON	DHW-CO4-07 = ON

7.5 Parallel pump operation

This function can only be activated in systems AnI 2.1.0 and 2.2.0.

The function block setting DWW-CO4-06 = ON, the heating pump UP1 remains switched on during DHW heating unless certain operating situations occur. These situations include, for example, those when the current flow temperature demand of the pump circuit is lower than 'Min. flow set point in heating circuit for parallel pump operation'. In this case, the controller applies priority operation with intermediate heating. Once a parallel pump operation cycle has been activated and the time for 'Delay of cancelation due to system deviation' has elapsed, system deviations greater than 5 °C cause the controller to suspend parallel operation for ten minutes and to apply priority operation.

By setting 'Delay of cancelation due to system deviation' to 0 min. leads to a parallel operation once initiated to remain regardless of a deviation.

Note: The **Intermediate heating** and **Parallel pump operation** functions cannot be configured simultaneously. When DHW-CO4-06 = ON is configured, DHW-CO4-07 = ON cannot be selected and vice versa.

Function	WE	Configuration
Parallel pump operation	OFF	DHW-CO4-06 = ON
	10 min	Delay of cancelation due to system deviation / 0 to 10 min
	40.0 °C	Min. flow set point in heating circuit for parallel pump operation / 20.0 to 90.0 °C

7.6 Circulation pump operation during storage tank charging

The function block setting DHW-CO4-11 = ON causes the circulation pump to continue running according to the programmed time schedule even during storage tank charging.

The function block setting DHW-CO4-11 = OFF causes the circulation pump to be switched off as soon as the storage tank charging pump is activated. The circulation pump restarts according to the time schedule when the storage tank charging pump has been switched off again

Function	WE	Configuration
Circulation pump operation during storage tank charging	OFF	DHW-CO4-11

7.7 Priority operation

In many district heating systems with primary DHW heating, the allotted amount of water cannot meet DHW heating and heating operation demands when they are required at the same time. As a result, the capacity required for DHW heating needs to be taken from the heating system when great heating loads occur; and this, until DHW heating has been concluded.

Nevertheless, heating operation is not to be interrupted simply. Only the amount of energy required for DHW heating is to be deducted. This can be achieved by using the priority functions **Reverse control** and **Set-back operation**.

7.7.1 Reverse control

In all systems with DHW heating and a heating circuit with control valve, DHW heating can be given priority by applying reverse control. The function block setting DHW-CO4-08 = ON allows the temperature at the flow sensor DHW to be monitored.

In systems without the flow sensor DHW, the temperature directly at the storage tank sensor is monitored. If system deviations still occur after the time entered in 'Delay of reverse control active' has elapsed, the set point of the heating circuit with control valve is gradually reduced each minute until the flow temperature set point has reached 5 °C at the minimum. How strongly the controller responds is determined by the 'Correction factor'.

When 'Delay of reverse control active' is set to 0 min, the priority operation is started regardless of the time and temperature in the system. The control valve in the heating circuit is closed.

Note: The **Reverse control** and **Set-back operation** functions cannot be configured simultaneously. When DHW-CO4-08 = ON is configured, DHW-CO4-09 = ON cannot be selected and vice versa.

Functions	WE	Configuration
Priority by reverse control	OFF	DHW-CO4-08 = ON
	2 min	Delay of reverse control active / 0 to 10 min
	1.0	Correction factor / 0.1 to 1.0

7.7.2 Set-back operation

In all systems with DHW heating and a heating circuit with control valve, DHW heating can be given priority by applying set-back operation. The function block setting DHW-CO4-09 = ON allows the temperature at the flow sensor DHW to be monitored.

In systems without the flow sensor DHW, the temperature directly at the storage tank sensor is monitored. If system deviations still occur after the time entered in 'Delay of set-back operation active' has elapsed, the heating circuit with control valve is switched to reduced mode.

When 'Delay of set-back operation active' is set to 0 min, the priority operation is started regardless of the time and temperature in the system.

Note: The **Reverse control** and **Set-back operation** functions cannot be configured simultaneously. When DHW-CO4-08 = ON is configured, DHW-CO4-09 = ON cannot be selected and vice versa.

Function	WE	Configuration
Priority by set-back operation	OFF	DHW-CO4-09 = ON
	2 min	Delay of set-back operation active / 0 to 10 min

7.8 Forced charging of the DHW storage tank

To provide the full room heating performance when the time-of-use of the heating circuit begins, storage tanks are charged one hour before the time-of-use of the heating circuit starts.

For the individual controller, this means that storage tank charging is activated when the water temperature in the storage tank falls below the deactivation value of $T = \text{'DHW day set point'} + \text{'Hysteresis'}$.

The forced charging of the storage tank does not take place when the DHW circuit is not used at the beginning of the time-of-use programmed for the heating circuit.

Note: *This function is not available when a storage tank thermostat is used.*

7.9 Thermal disinfection of the DHW storage tank

In all systems with DHW heating in storage tank system or in storage tank charging system, a thermal disinfection is performed on the selected 'Day of week for thermal disinfection' or daily (by selecting 8). The DHW storage tank is heated up to the adjusted 'Disinfection temperature' taking the 'Charging temperature boost' parameter (or function block parameter 'Thermal disinfection boost' depending on the system) into account. Disinfection begins at the adjusted 'Start time of thermal disinfection' and, at the latest, ends at the specified 'Stop time of thermal disinfection'. The 'Disinfection temperature sustaining time' determines how long the disinfection temperature must be maintained within the adjusted time period to rate the process successful. If the 'Disinfection temperature sustaining time' is set to 0 min, no intermediate heating operation takes place during thermal disinfection.

Alternatively, the thermal disinfection can be started over an binary signal to S4. When 'Day of week for thermal disinfection' is set to 9 or 10, the start and stop times do not need to be entered.

- ▶ When 'Day of week for thermal disinfection' is set to 9, the thermal disinfection starts when the binary input closes and stops when the binary input opens.
- ▶ When 'Day of week for thermal disinfection' is set to 10, the thermal disinfection starts when the binary input opens and stops when the binary input closes.

When the 'Disinfection temperature' has not been reached before the end of the thermal disinfection cycle, the 'Disinfection stopped' error message is generated. This error message can also be generated prematurely if the remaining time until the disinfection temperature is reached is shorter than the adjusted 'Disinfection temperature sustaining time'. The error message is automatically reset when the 'Disinfection temperature' is properly reached during the following thermal disinfection cycle.

Functions of the DHW circuit

Optionally, the controller can indicate an active thermal disinfection at the fault indication output. In this case, the fault alarm function must be deactivated.

Thermal disinfection for preventing legionella infection causes

- ▶ excessively high return flow temperatures during the disinfection cycle (return flow temperature limitation suspended),
- ▶ excessively high DHW temperatures after thermal disinfection has been concluded
- ▶ lime scale (possibly), which can have a negative effect on heat exchanger performance

Note:

- *This function is not available when a storage tank thermostat is used.*
- *The connection of the fault indication output with DHW-CO4-15 = ON differs depending on the system. Refer to the fold-out page.*

Functions	WE	Configuration
Storage tank sensor S7	OFF	DHW-CO4-01 = ON
Thermal disinfection	OFF	DHW-CO4-14 = ON
	00:00 h	Start time of thermal disinfection / 00:00 to 23:45 h
	04:00 h	Stop time of thermal disinfection / 00:00 to 23:45 h
	70.0 °C	Disinfection temperature / 60.0 to 90.0 °C
	0 min	Disinfection temperature sustaining time / 0 to 255 min
	10.0 °C	Thermal disinfection boost / 0.0 to 5.0 °C
Indication of an active thermal disinfection at the binary output		
Binary output ON during thermal disinfection	OFF	DHW-CO4-15 = ON
Fault indication output	OFF	HC1-CO5-17 = OFF

8 System-wide functions

8.1 Automatic summer time/winter time switchover



The clock is automatically changed on the last Sunday in March at 2.00 h and on the last Sunday in October at 3.00 h.

Functions	WE	Configuration
Summer time/winter time switchover	ON	HC1-CO5-08 = ON

8.2 Frost protection

Frost protection measures are taken when the outdoor temperature falls below the 'Outdoor temperature for frost protection'. The switching differential to cancel the frost protection measures is always 1 °C.

- ▶ Frost protection without highest priority HC1-CO5-09 = OFF (restricted frost protection): Frost protection measures are taken only when no heating operation takes place in the system. The heating pumps are automatically switched on and their flow temperature set points are adjusted to 10 °C. The circulation pump in the DHW circuit is automatically switched on only when the heating circuit of the system, if one exists, is inactive. Nevertheless, the storage tank is always recharged to 10 °C if the storage tank temperature falls below 5 °C.
- ▶ Frost protection with highest priority HC1-CO5-09 = ON: The heating pumps are always switched on automatically. The flow temperature set points of all heating circuits currently in stand-by mode are set to 10 °C. In the DHW circuit, the circulation pump is always activated. If the storage tank temperature falls below +5 °C, the storage tank is recharged to +10 °C.

Note: In stand-by mode, the frost protection symbol  appears on the screen instead of  when the outdoor temperature falls below the adjustable 'Outdoor temperature for frost protection'.

Functions	WE	Configuration
Frost protection with highest priority	3.0 °C	HC1-CO5-09 = OFF: Restricted frost protection HC1-CO5-09 = ON: Frost protection with highest priority Outdoor temperature for frost protection / -15.0 to 3.0 °C

8.3 Forced operation of the pumps

When the heating circuit pumps have not been activated for 24 hours, forced operation of the pumps is started between 12.02 h and 12.03 h. This is done to avoid that the pumps get stuck when they are not operated for a longer period of time. In the DHW circuit, the circulation pump is operated between 12.04 h and 12.05 h, the other pumps between 12.05 h and 12.06 h.

8.4 Return flow temperature limitation

The temperature difference between the flow and return flow indicates how well the energy is used: the greater the difference, the higher the efficiency. A return flow sensor is sufficient to evaluate the temperature difference when the network flow temperatures are fixed to a certain temperature. The return flow temperature can be limited either to a value depending on the outdoor temperature (variable) or to a fixed set point. When the temperature measured at return flow sensor exceeds the 'Limiting factor', the set point of the flow temperature (flow temperature of the heating system, charging temperature) is reduced. As a result, the primary flow rate is reduced and the return flow temperature falls.

In systems 2.1.0 and 2.2.0, the 'Max. return flow temperature' parameter (DHW-PA4) is used for limitation in the primary circuit during DHW heating if it is greater than the parameter valid for the primary circuit. The 'Limiting factor' determines how strongly the controller responds to limit violations (P algorithm).

If the PI action is to be implemented, configure HC1-CO5-16 = ON. This allows the integral-action component in the return flow temperature limitation algorithm of all control circuits of the controller to be activated.

NOTICE

To keep the determined return flow temperature limit, make sure that:

- the heating characteristic is not selected to be too steep*
- the speed of the heating pumps is not selected to be too high*
- the heating systems are hydronically balanced.*

Note: *Using weather-compensated control with gradient characteristic, the return flow temperature is limited to a fixed value by equating the 'Return flow temperature foot' and 'Max. return flow temperature' parameters.*

Functions	WE	Configuration
Return flow temperature measurement	1.0	HC1-CO1-03 = ON Limiting factor / 0.1 to 10.0
Return flow temperature measurement	1.0	DHW-CO4-03 = ON Limiting factor / 0.1 to 10.0
Control algorithm:		
Return flow limitation by PI algorithm	OFF	HC1-CO5-16 = OFF: P algorithm HC1-CO5-16 = ON: PI algorithm
Parameters	WE	Parameter settings
Return flow gradient	1.0	HC1-PA1-11 / 0.2 to 3.2
Return flow level	0.0 °C	HC1-PA1-12 / -30.0 to 0.0 °C
Return flow temperature foot	65.0 °C	HC1-PA1-13 / 5.0 to 90.0 °C
Max. return flow temperature	65.0 °C	HC1-PA1-14 / 5.0 to 90.0 °C
Return flow temperature, points 1 to 4	65.0 °C	HC1-PA1-05 / 5.0 to 90.0 °C
Max. return flow temperature	65.0 °C	DHW-PA4-07 / 20.0 to 90.0 °C

8.5 Condensate accumulation control

Activate the **OPEN signal damping** function to start up condensate accumulation plants, in particular to avoid problematic excess temperatures. The controller response to set point deviations which cause the primary valve to open is attenuated. The controller response to set point deviations which cause the control valve to close remains unaffected.

Note: The condensate accumulation control function can only be activated when three-step control has been configured for the control circuit (refer to section 8.6).

Functions	WE	Configuration
Three-step control	ON	HC1-CO1-12 = ON
OPEN signal damping	OFF 2.0 °C	HC1-CO1-13 = ON Max. system deviation / 2.0 to 10.0 °C
Three-step control	ON	DHW-CO4-12 = ON
OPEN signal damping	OFF 2.0 °C	DHW-CO4-13 = ON Max. system deviation / 2.0 to 10.0 °C

8.6 Three-step control

The flow temperature can be controlled using a PI algorithm. The valve reacts to pulses that the controller sends when a system deviation occurs. The length of the first pulse, in particular, depends on the extent of the system deviation and the selected 'Gain KP' (the pulse length increases as KP increases). The pulse and pause lengths change continuously until the system deviation has been eliminated. The pause length between the single pulses is greatly influenced by the 'Reset time TN' (the pause length increases as TN increases). The 'Valve transit time TY-OPEN' specifies the time required by the valve to travel through the range of 0 to 100 %.

Functions	WE	Configuration
Three-step control	ON	HC1-CO1-12 = ON
	2.0	Gain KP / 0.1 to 50.0
	120 s	Reset time TN / 0 to 999 s
	0 s	Derivative-action time TV / 0 to 999 s
	45 s	Valve transit time TY-OPEN / 10 to 240 s

Three-step control	ON	DHW-CO4-12 = ON
	2.0	Gain KP / 0.1 to 50.0
	120 s	Reset time TN / 0 to 999 s
	0 s	Derivative-action time TV / 0 to 999 s
	45 s	Valve transit time TY-OPEN / 10 to 240 s

8.7 On/off control

The flow temperature can be controlled, for example, by activating and deactivating a boiler. The controller switches on the boiler when the flow temperature falls below the set point by $T = 0.5 \times \text{'Hysteresis'}$. When the flow temperature exceeds the set point by $T = 0.5 \times \text{'Hysteresis'}$, the boiler is switched off again. The greater the value you choose for 'Hysteresis', the less the switching frequency will be. By setting the 'Min. ON time', an activated boiler remains switched on during this period regardless of the flow temperature fluctuations. Similarly, a deactivated boiler will remain switched off regardless of the flow temperature fluctuations if the 'Min. OFF time' has been specified.

Functions	WE	Configuration
Three-step control	ON	HC1-CO1-12 = OFF
	5.0 °C	Hysteresis / 2.0 to 10.0 °C
	120 s	Min. ON time / 0 to 600 s
	120 s	Min. OFF time / 0 to 600 s

Functions	WE	Configuration
Three-step control	ON	DHW-CO4-12 = OFF
	5.0 °C	Hysteresis / 2.0 to 10.0 °C
	120 s	Min. ON time / 0 to 600 s
	120 s	Min. OFF time / 0 to 600 s

8.8 Unlocking a controller/control loop 1 over the binary input

The unlocking of the control circuit or controller using the binary input only becomes effective when the control circuit or controller is in automatic mode.

An active control circuit or controller always works in automatic mode, whereas the deactivated controller behaves as if it were switched to stand-by mode. It remains active, however, in any case for processing an external demand. The controller can be unlocked over the binary input S5 when the binary input is either a make contact (switching state of the controller or control loop 1 active = 0) or a break contact (switching state of the controller or control loop 1 active = 1).

Note: *Unlocking the control loop 1 over the binary input only influences the operation of this heating circuit in systems with supplementary heating circuit without a valve (Anl. 2.1.0 and 2.2.0).*

Functions	WE	Configuration
Unlock control loop 1 at S5	OFF	HC1-CO1-14 = ON
	1	Control loop 1 switching state active / 0, 1
Unlock controller at S5	OFF	HC1-CO5-15 = ON
	1	Controller switching state active / 0, 1

8.9 Processing an external demand

The controller can process binary or analog demands for an externally required signal by a more complex secondary system.

NOTICE

Overheating may occur in the heating circuits of the primary controller without control valve.

Excessive charging temperatures in DHW circuits without control valve controlled by the primary controller are excluded when the default settings of the controller are used: while storage tank charging is active, no flow temperature higher than the charging temperature is used by the primary controller. Nevertheless, if the **Priority for external demand** function is activated, the external demand is also processed during storage tank charging.

Functions	WE	Configuration
Priority for external demand	OFF	DHW-CO4-17 = ON

8.9.1 Processing an external demand with a binary signal

Regardless of the operating mode for control loop 1, except for manual mode, the flow temperature entered in 'Min. flow set point in heating circuit with active binary demand' is used in control circuit HC1 when the binary input is either a make contact (Demand switching state active = 1) or a break contact (Demand switching state active = 0).

Note: *The connection of the binary input with the setting HC1-CO1-17 = ON depends on the system selected. Refer to the fold-out page.*

Functions	WE	Configuration
Binary demand processing	OFF	HC1-CO1-17 = ON
	1	Demand switching state active / 0, 1
Parameter	WE	Parameter settings
Min. flow set point in heating circuit with active binary demand	40.0 °C	HC1-PA1-10 / 5.0 to 50.0 °C

8.9.2 Processing an external demand with a 0 to 10 V signal

The controller (= primary controller) can process analog external demands. The 0 to 10 V signal is interpreted as a flow temperature demand of 0.0 to 120.0 °C, i.e. the flow temperature demand is 12 °C/V.

The set point of the downstream secondary controller is read at the analog input UI1 and compared with the controller's own flow temperature set point. The higher of the flow temperature set points plus 'Set point boost of pre-control loop' is used by the controller to regulate the flow temperature. The 'Set point boost of pre-control loop' parameter improves the control behavior of the downstream heating circuit instruments and compensates for any loss in capacity.

Functions	WE	Configuration
Demand processing 0-10 V at UI1	OFF	HC1-CO1-16 = ON
Primary controller: Parameter	WE	Parameter settings
Set point boost of pre-control loop	5 °C	HC1-PA1-15 / 0.0 to 50.0 °C

8.10 Demand requested with a 0 to 10 V signal

The controller can request its maximum flow set point (with boost, if required) by issuing a 0 to 10 V signal. The output UO1 is used.

Function	WE	Configuration
Demand 0–10 V at UO1	OFF	HC5-CO5-18 = ON
	0.0 °C	Lower transmission range value, demand / 0.0 to 130.0 °C
	120.0 °C	Upper transmission range value, demand / 0.0 to 130.0 °C
	30.0 °C	Demand boost / 0.0 to 30.0 °C

8.11 Forwarding the measured outdoor temperature

The controller can make the measured outdoor temperature available to a downstream controller. The 'Lower transmission range value, outdoor temperature' and the 'Upper transmission range value, outdoor temperature' is assigned to a 0 to 10 V signal. The downstream controller uses the outdoor temperature to determine the flow rate temperature.



Functions	WE	Configuration
Outdoor temperature 0–10 V at UO1	OFF	HC1-CO5-07 = ON
	-20.0 °C	Lower transmission range value, outdoor temperature / -30.0 to 100.0 °C
	50.0 °C	Upper transmission range value, outdoor temperature / -30.0 to 100.0 °C

8.12 Locking the manual level



To protect the heating system, this function can be used to lock the manual level.

Functions	WE	Configuration
Lock manual level	OFF	HC1-CO5-22 = ON

9 Operational faults

If the controller detects an error, the  key is replaced by the  key on the start screen. The ERROR key blinks.

Read error list

The following instructions describe the procedure starting from the start screen (see page 8). The  key blinks where normally the  key is located.

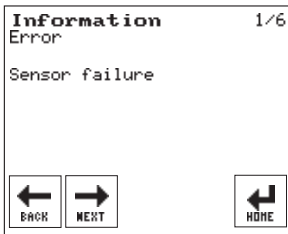

 Open the error list.

The menu item for error information is displayed.
The following errors are listed:

Drying of jointless floors (refer to section 6.3)

Max. charging temp. reached (refer to section 7.2)

Sensor failure (refer to section 9.1)

Temperature monitoring (refer to section 9.2)

Default settings read

Confirming errors

After the error has been remedied or confirmed, the error is deleted from the menu item on error information. Should the error remain after confirmation, it is added to the menu item again after a short time.

9.1 Sensor failure

Sensor failures are indicated by 'Sensor failure' in the error list. For detailed information, exit the error level and read the different temperature values in the information level: each sensor icon displayed together with '-.-' instead of the measured temperature indicates a defective sensor. The following list explains how the controller responds to the failure of the different sensors.

- ▶ **Outdoor sensor:** When the outdoor sensor fails, the controller uses a flow temperature set point of 50 °C or 'Max. flow temperature' when the 'Max. flow temperature' is lower than 50 °C.
- ▶ **Flow sensor:** When the flow sensor in the heating circuit is defective, the associated valve moves to 30 % travel. DHW heating using such a sensor to measure the charging temperature is suspended.
- ▶ **Flow sensors in the DHW circuit:** When the flow sensor fails, the controller behaves as if the flow sensor had not been configured. As soon as the control of the charging temperature becomes impossible, the associated valve is closed.
- ▶ **Return flow sensor:** When the return flow sensor fails, the controller continues operation without return flow temperature limitation.
- ▶ **Room sensor:** When the room sensor fails, the controller uses the settings for operation without room sensor. The controller, for example, switches from optimizing mode to reduced operation; adaptation mode is canceled. The last determined heating characteristic remains unchanged.
- ▶ **Top and bottom storage tank sensors:** When one of the two sensors fails, the storage tank is no longer charged.

9.2 Temperature monitoring

When certain measured temperatures deviate from the set points by a defined amount, an error message is generated. The following deviations lead to the 'Temperature monitoring' error message:

- ▶ The flow temperature deviates from the set point by at least 10.0 °C for longer than 30 minutes
- ▶ The room temperature is at least 2.0 °C lower than the set point (flash adaptation active) for longer than 30 minutes
- ▶ The return flow temperature limitation has continuously taken effect for longer than 30 minutes

Functions	WE	Configuration
Temperature monitoring	OFF	HC1-CO5-19 = ON

9.3 Collective fault alarm

When this function is configured, the fault indication output is activated when an error exists (-> Section 5 for the assignment). Any errors still appear in the error list.

Functions	WE	Configuration
Fault indication output	OFF	HC1-CO5-17 = ON

10 Installation

The TROVIS 5610 Heating Controller is designed for panel and wall mounting.

Note: If the controller is to be fitted with one of the optional interface boards, the interface board must be inserted before the controller is mounted (Interface boards → Section 12).

Panel mounting

Required accessories:

Panel mounting set (for compact version) Order no. 1402-0538

Panel mounting set (for standard version) Order no. 1402-0530

The panel mounting set consists of terminal strips for the wiring and two clamps to lock the controller housing in place.

The controller without a base is used for panel mounting.

1. Make a cut-out of 138 x 92 mm (W x H) in the control panel.
2. Insert the controller housing through the panel cut-out.
3. Lock the housing in place in the control panel using the clamps on both sides.
4. Perform the electrical connection as described in section 11).
5. Plug the terminal strips onto the back of the controller. The terminal strips are coded mechanically, which prevents the connections from being mixed up.

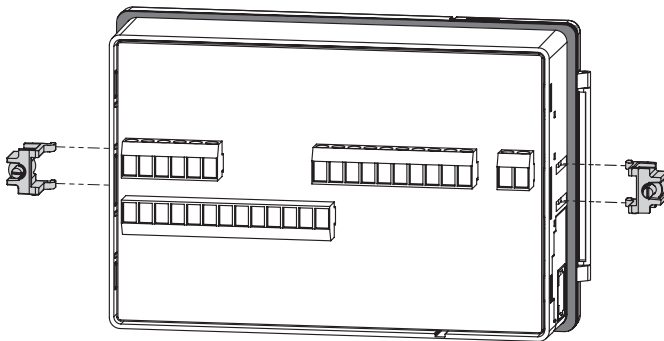

Fig. 8 · Panel mounting

Wall mounting

Required accessories:

Wall mounting base (for compact version)

Order no. 1402-0529

Wall mounting base (for standard version)

Order no. 1402-0323

The base consists of two base components (base housing and frame), a terminal board for the wiring, two wire connectors (for five conductors) for N and PE distribution as well as two clips to hold the controller housing in place.

1. Knock out the required cable openings on the bottom of the base housing.

NOTICE

If the cable openings on top of the base housing are used, the degree of protection (IP 40 without seal for panel mounting, IP 41 with seal for panel mounting) cannot be maintained.

2. Attach the base housing to the wall using four screws (arrows pointing upward).
3. Insert the terminal board into the base housing with the terminals N and L facing upward.
4. Perform the electrical connection as described in section 11.
5. Place the frame on the base housing and screw them together.
6. Place the controller housing into the frame and insert the two clips on each side to lock the housing in place.

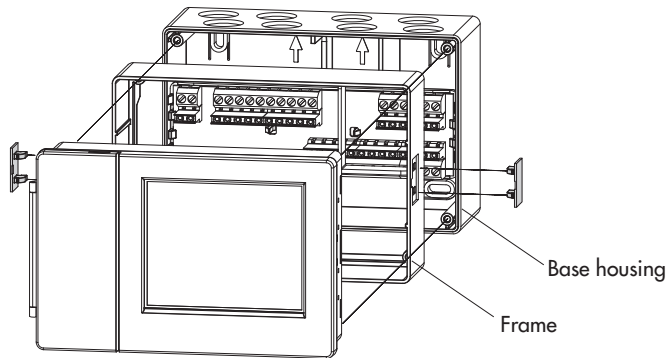

Fig. 9 · Wall mounting

Note: A bracket for the base (order no. 8864-0168) is available for top-hat rail mounting.

11 Electrical connection

DANGER!

Risk of electric shock!

For electrical installation, you are required to observe the relevant electrotechnical regulations of the country of use as well as the regulations of the local power suppliers. Make sure all electrical connections are installed by trained and experienced personnel!

Notes on installing the electrical connections

- ▶ Install the 230 V power supply lines and the signal lines separately! To increase noise immunity, observe a minimum distance of 10 cm between the lines. Make sure the minimum distance is also observed when the lines are installed in a cabinet.
- ▶ The lines for digital signals (bus lines) and analog signals (sensor lines, analog outputs) must also be installed separately!
- ▶ In plants with a high electromagnetic noise level, we recommend to use shielded cables for the analog signal lines. Ground the shield at one side, either at the control cabinet inlet or outlet, using the largest possible cross-section. Connect the central grounding point and the PE grounding conductor with a cable $\geq 10 \text{ mm}^2$ using the shortest route.
- ▶ Inductances in the control cabinet, e.g. contactor coils, are to be equipped with suitable interference suppressors (RC elements).
- ▶ Control cabinet elements with high field strength, e.g. transformers or frequency converters, should be shielded with separators providing a good ground connection.

Overvoltage protection

- ▶ If signal lines are installed outside buildings or over large distances, make sure appropriate surge or overvoltage protection measures are taken. Such measures are indispensable for bus lines!
- ▶ The shield of signal lines installed outside buildings must have current conducting capacity and must be grounded on both sides.
- ▶ Surge diverters must be installed at the control cabinet inlet.

Connecting the controller

The controller is connected as illustrated in the wiring diagram (pages 94 and 95).

Open the housing to connect the cables. To connect the feeding cables, make holes at the marked locations at the bottom of the rear part of the housing.

Connecting sensors

Cables with a min. cross-section of 0.5 mm^2 and max. cross-section of 2.5 mm^2 can be connected to the terminal strips at the back panel of the housing for panel mounting and to the terminal blocks of the base.

Connecting actuators

- ▶ 0 to 10 V control output
Connect cables with a min. cross-section of $2 \times 0.5 \text{ mm}^2$.
- ▶ Three-step/on/off control outputs
Route wires with at least 1.5 mm^2 suitable for damp locations to the terminals of the controller output. The direction of travel needs to be checked at start-up.

Connecting pumps

Route all wires with a minimum cross-section of 1.5 mm^2 to the controller terminals as shown in the wiring diagram.

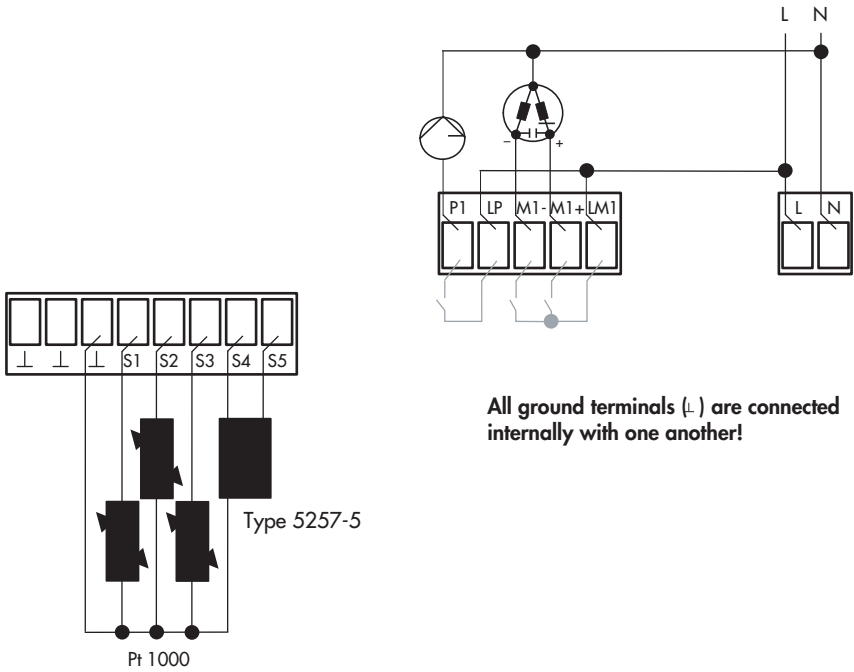
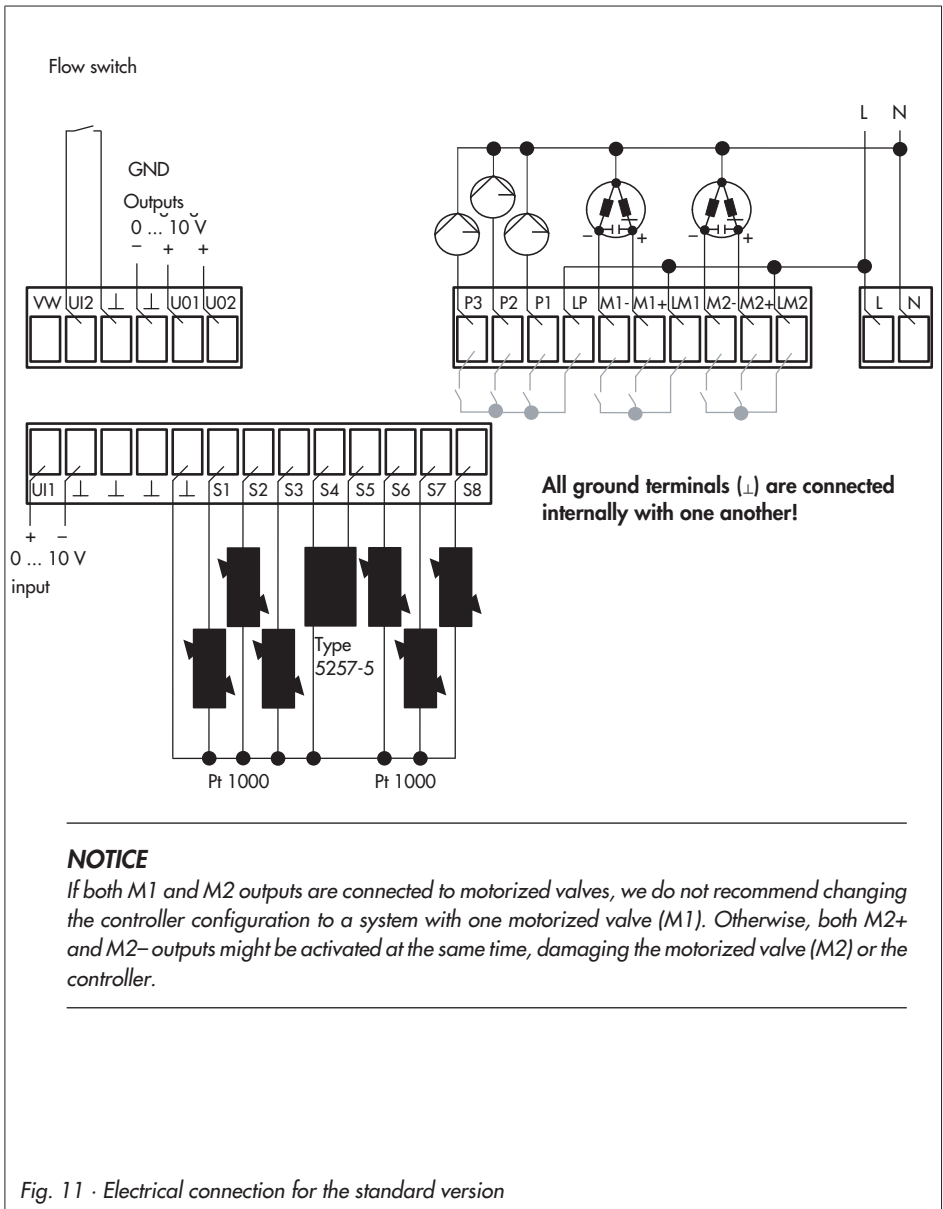

Fig. 10 · Electrical connection for the compact version



12 Interfaces

The TROVIS 5610 Controller can be fitted with interface boards for communication. Various interface boards are available. The interface board required for the memory pen (refer to section 12.1) can be ordered with the order no. 1402-0321.

Retrofitting interfaces

1. Remove the dummy module on the left side of the controller.
2. Insert the interface board.



Fig. 12 · Inserting the interface board

12.1 Memory pen

The use of a memory module (order no. 1400-9379) is particularly useful to transfer all data from one TROVIS 5610 Controller to several other TROVIS 5610 Controllers.

The memory module is plugged into the RJ-12 jack at the front of the controller (optional interface board (1402-0321) is required). Once the module has been connected, 'READ COPA FROM MEMORY PEN' and 'SAVE COPA TO MEMORY PEN' buttons appear on the screen, provided the memory pen already contains data from a TROVIS 5610 Controller. If the memory pen is empty or contains data from a different controller model, only the 'SAVE COPA TO MEMORY PEN' button appears. After data transfer has been completed, 'OK. Remove pen' appears. If data transfer is not completed successfully, 'Error' appears on the screen.

12.2 TROVIS-VIEW

The TROVIS-VIEW software can be used to configure the controller and change parameter settings. It can be connected directly to the controller when the controller is fitted with a suitable interface board or indirectly using a memory pen. The software is based on the modular principle and consists of an operator interface, a communications server and device-specific modules. The operation of TROVIS-VIEW is similar to Windows® Explorer.

The TROVIS-VIEW software can be downloaded from the SAMSON website (Services > Software > TROVIS-VIEW). It is also available on a CD-ROM on request.

13 Appendix

13.1 Configuration levels

Compact version: Anl. 1.0.0, 1.0.1, 3.5.0 (= all HC1)

Standard version: Anl. 1.0.0, 1.0.1, 1.1.0, 1.1.1, 1.2.0, 2.0.0, 2.1.0, 2.2.0, 3.5.0, 11.0.0, 11.9.0, 11.9.1 (= all HC1)

Heating circuit HC1

HC1-CO1-	Function	Anl	WE	Comment Function block parameters / Range of values
01	Room temperature measurement	Not Anl. 1.9.0 1.9.1	OFF	OFF: Room sensor inactive ON: Temperature reading and input FG1 for Type 5257-5 Room Panel active
02	Outdoor temperature measurement	Not Anl. 1.9.0 1.9.1	ON	OFF: Fixed set point control ON: Weather-compensated control
03	Return flow temperature measurement	Not Anl. 1.9.0 1.9.1	OFF* ON** 1.0	OFF: Function inactive ON: Return flow temperature measurement and limitation active Function block parameter: Limiting factor / 0.1 to 10.0 * Anl. 1.0.1, 1.1.1, 1.2.0 ** Anl. 1.0.0, 1.1.0, 2.0.0, 2.1.0, 2.2.0, 3.5.0, 11.0.0, 11.9.0, 11.9.1
04	Outdoor temperature 0-10 V at UI1	All ^{HC1}	OFF -20.0 °C 50.0 °C	OFF: Function inactive ON: Outdoor temperature measurement at input UI1; only when • HC1-CO1-02 = ON Function block parameters: Lower transmission range value, outdoor temperature / -30.0 to 100.0 °C Upper transmission range value, outdoor temperature / -30.0 to 100.0 °C
05	Underfloor heating	Not Anl. 1.9.0 1.9.1 3.5.0	OFF	OFF: Function inactive ON: Restriction of adjustment ranges Function block parameters: See next page

HC1-CO1-	Function	Anl	WE	Comment Function block parameters / Range of values
05	Underfloor heating (continued)		25.0 °C 5.0 °C/day 45.0 °C 4 days 0.0 °C/day 0	Function block parameters: Start temperature / 20.0 to 60.0 °C Temperature increase / 1.0 to 10.0 °C/day Max. temperature / 2.0 to 60.0 °C Max. temperature sustaining time / 1 to 10 days Temperature reduction / 0.0 to 10.0 °C/day Start / 0 to 5
06	Optimization based on outdoor temperature	Not Anl. 1.9.0 1.9.1 3.5.0	OFF 120 min	OFF: No optimization ON: Optimization active; only when • HC1-CO1-02 = ON Function block parameter: Preheating time / 0 to 360 min
07	Optimization based on room temperature	Not Anl. 1.9.0 1.9.1 3.5.0	OFF	OFF: No optimization ON: Optimization active; only when • HC1-CO1-01 = ON Function block can only be selected when • HC1-CO1-06 = OFF and • HC1-CO1-08 = OFF
08	Optimization based on outdoor and room temperature	Not Anl. 1.9.0 1.9.1 3.5.0	OFF 120 min	OFF: No optimization ON: Optimization active; only when • HC1-CO1-01 = ON • HC1-CO1-02 = ON Function block can only be selected when • HC1-CO1-06 = OFF and • HC1-CO1-07 = OFF Function block parameter: Preheating time / 0 to 360 min
09	Flash adaptation	Not Anl. 1.9.0 1.9.1 3.5.0	OFF 20 min 0.0	OFF: Function inactive ON: Flash adaptation active; only when • HC1-CO1-01 = ON Function block parameters: Cycle time / 0 to 100 min Gain / 0.0 to 25.0
10	Adaptation	Not Anl. 1.9.0 1.9.1 3.5.0	OFF	OFF: Function inactive ON: Adaptation active; only when • HC1-CO1-01 = ON and • HC1-CO1-02 = ON and • HC1-CO1-11 = OFF

HC1-CO1-	Function	Anl	WE	Comment Function block parameters / Range of values
11	Four-point characteristic	Not Anl. 1.9.0 1.9.1 3.5.0	OFF	OFF: Gradient characteristic ON: Four-point characteristic; only when • HC1-CO1-10 = OFF
12	Three-step control	Not Anl. 1.9.0 1.9.1	ON 5.0 °C 120 s 120 s 2.0 120 s 0 s 45 s	OFF: On/off control ON: Three-step control Function block parameters: On/off control Hysteresis / 2.0 to 10.0 °C Min. ON time / 0 to 600 s Min. OUT time / 0 to 600 s Three-step control Gain KP / 0.1 to 50.0 Reset time TN / 0 to 999 s Derivative-action time TV / 0 to 999 s; Do not change this value! Valve transit time TY-OPEN / 10 to 240 s
13	OPEN signal damping	Not Anl. 1.9.0 1.9.1	OFF 2.0 °C	OFF: Function inactive ON: Damping active Function block parameter: Max. system deviation / 2.0 to 10.0 °C
14	Unlock control loop 1 at S5	All ^{HC1}	OFF 1	OFF: Function inactive ON: Unlock control loop 1 at S5 depending on the switching state Function block parameter: Control loop 1 switching state active / 0, 1
15	Set point correction using 0-10 V	Not Anl. 1.9.0 1.9.1 3.5.0	OFF	OFF: Function inactive ON: Set point correction active
16	Demand processing 0-10 V at UI1	Not Anl. 1.9.0 1.9.1	OFF	OFF: Function inactive ON: Demand processing at UI1 active
17	Binary demand processing	Not Anl. 1.9.0 1.9.1	OFF 1	OFF: Function inactive ON: Binary demand processing active Function block parameter: Demand switching state active / 0, 1

DHW heating

Compact version: Anl. 1.9.0, 1.9.1 (= All DHW)

Standard version: Anl. 1.1.1, 1.2.0, 1.6.0, 1.6.1, 1.6.2, 1.9.0, 1.9.1, 2.0.0, 2.1.0, 2.2.0, 11.0.0, 11.9.0, 11.9.1 (= All DHW)

DHW-CO4-	Function	Anl	WE	Comment Function block parameters / Range of values
01	Storage tank sensor S7	Not Anl. 1.9.0 1.9.1 11.0.0 11.9.0 11.9.1	OFF	OFF: Storage tank thermostat ON: Storage tank sensor Function block can only be selected when <ul style="list-style-type: none"> • DHW-CO4-02 = OFF
02	Storage tank sensor S8 (bottom)	Not Anl. 1.9.0 1.9.1 11.0.0 11.9.0 11.9.1	OFF* ON**	OFF: Storage tank sensor S8 not active ON: Storage tank sensor S8 active Function block can only be selected when <ul style="list-style-type: none"> • DHW-CO4-01 = ON * Anl. 1.1.0, 1.1.1, 2.0.0, 2.1.0 ** Anl. 1.2.0, 1.6.0, 1.6.1, 1.6.2, 2.2.0
03	Return flow temperature measurement	Not Anl. 1.1.0 1.1.1 1.2.0 2.0.0 2.1.0 2.2.0	OFF* ON** 1.0	OFF: Return flow sensor not active ON: Return flow temperature measurement and limitation active Function block parameter: Limiting factor / 0.1 to 10.0 * Anl. 1.6.2 ** Anl. 1.6.0, 1.6.1, 1.9.0, 1.9.1, 11.0.0, 11.9.0, 11.9.1
04	Flow rate detection	Only Anl. 1.9.0, 11.9.0, 11.9.1	OFF	OFF: Function inactive ON: Flow rate detection active
05	Flow sensor DHW	Not Anl. 1.9.0 1.9.1 2.0.0 2.1.0 11.0.0 11.9.0	OFF	OFF: Flow sensor DHW not active ON: Flow sensor for measuring the storage tank charging temperature active

DHW-CO4-	Function	Anl	WE	Comment Function block parameters / Range of values
06	Parallel pump operation	Only Anl. 2.1.0 2.2.0	OFF 10 min 40.0 °C	OFF: Function inactive ON: Parallel pump operation Function block can only be selected when • DHW-CO4-07 = OFF Function block parameters: Delay of cancelation due to system deviation / 0 to 10 min Min. flow set point in heating circuit for parallel pump operation / 20.0 to 90.0 °C
07	Intermediate heating	Only Anl. 2.0.0 2.1.0 2.2.0	ON	OFF: Storage tank charging unrestricted; heating operation with UP1 has priority over DHW heating ON: DHW limited to 20 minutes, then 10 minutes heating operation with P1 (UP) Function block can only be selected when • DHW-CO4-06 = OFF
08	Priority by reverse control	Only Anl. 1.1.0 1.1.1 1.2.0 11.0.0 11.2.0 11.9.0 11.9.1	OFF 2 min 1.0	OFF: Function inactive ON: Priority by reverse control active, only when • DHW-CO4-09 = OFF Function block parameters: Delay of reverse control active / 0 to 10 min Correction factor / 0.1 to 1.0
09	Priority by set-back operation	Only Anl. 1.1.0 1.1.1 1.2.0 11.0.0 11.2.0 11.9.0 11.9.1	OFF 2 min	OFF: Function inactive ON: Priority by set-back operation active, only when • DHW-CO4-08 = OFF Function block parameter: Delay of set-back operation active / 0 to 10 min
10	Circulation return flow in heat exchanger	Only Anl. 1.6.0 1.6.1 1.6.2	OFF	OFF: Function inactive ON: Active control of DHW heating when circulation pump is active
11	Circulation mode during storage tank charging	Only Anl. 1.9.0 1.9.1 11.0.0 11.9.0 11.9.1	OFF	OFF: Function inactive ON: Circulation pump runs during storage tank charging according to time schedule

DHW-CO4-	Function	Anl	WE	Comment Function block parameters / Range of values
12	Three-step control	Not Anl. 1.1.0 1.1.1 1.2.0 2.0.0 2.1.0 2.2.0	ON 5.0 °C 120 s 120 s 2.0 120 s 0 s 45 s	OFF: On/off control ON: Three-step control Function block parameters: On/off control: Hysteresis / 2.0 to 10.0 °C Min. ON time / 0 to 600 s Min. OFF time / 0 to 600 s Three-step control: Gain KP / 0.1 to 50.0 Reset time TN / 0 to 999 s Derivative-action time TV / 0 to 999 s Valve transit time TY-OPEN / 10 to 240 s
13	OPEN signal damping	Not Anl. 1.1.0 1.1.1 1.2.0 2.0.0 2.1.0 2.2.0	OFF 2.0 °C	OFF: Function inactive ON: Damping active Function block parameters: Max. system deviation / 2.0 to 10.0 °C
14	Thermal disinfection	Not Anl. 1.9.0 11.9.0 11.9.1	OFF 3 00:00 h 04:00 h 70.0 °C 10.0 °C 0 min	OFF: Function inactive ON: Thermal disinfection active Function block parameters: Day of week for thermal disinfection / 1 to 10 Start time for thermal disinfection / 00:00 to 23:45 h Stop time for thermal disinfection / 00:00 to 23:45 h Disinfection temperature / 60.0 to 90.0 °C Thermal disinfection boost / 0.0 to 5.0 °C Disinfection temperature sustaining time / 0 to 255 min
15	Binary output ON during thermal disinfection	Not Anl. 1.9.0	OFF	OFF: Function inactive ON: Binary output ON during thermal disinfection
16	SLP not ON unless return flow hot	Only Anl. 1.6.0 2.0.0 2.1.0	OFF	OFF Function inactive ON Storage tank charging pump is first switched on when the return flow is hot; only when • DHW-CO4-03 = ON Function block can only be selected when • HC1-CO1-03 = ON

DHW-CO4-	Function	Anl	WE	Comment Function block parameters / Range of values
17	Priority for external demand	Only Anl. 1.6.0 1.6.1 1.6.2 2.0.0 2.1.0 2.2.0	OFF	OFF: Function inactive ON: Priority for external demand WARNING! High external demand lead to excessive charging temperatures in DHW circuits without control valve.
18	Reserved			
19	Scheduled switchover between S7 and S8	Not Anl. 1.9.0 1.9.1 11.0.0 11.9.0 11.9.1	OFF	OFF: Function inactive ON: Time-controlled sensor switchover; only when <ul style="list-style-type: none"> • DHW-CO4-01 = ON and • DHW-CO4-02 = ON
20	Reserved			
21	Release control circuit 2 at S8	11.0.0 11.2.0 11.9.0	OFF 1	OFF: Function inactive ON: Control circuit released by binary input S8 Function block parameter: Switching state of control circuit 2 active / 0, 1

System-wide functions HC1

Compact version: Anl. 1.0.0, 1.0.1, 1.9.0, 1.9.1, 3.5.0

Standard version: All systems

HC1-CO5-	Function	Anl	WE	Comment Function block parameters / Range of values
01 03	Reserved			
04	Summer mode	Not Anl. 1.6.0 1.6.1 1.6.2 1.9.0 1.9.1 3.5.0	OFF 01.06 2 days 30.09 1 day 18.0 °C	OFF: Function inactive ON: Summer mode Function block parameters: Earliest start date for summer mode / User-definable Delay of summer mode active / 1 to 3 days Latest stop date for summer mode / User-definable Delay of heating mode active / 1 to 3 days Outdoor temperature for summer mode / 0.0 to 30.0 °C
05	Delay decreasing outdoor temperature	Not Anl. 1.9.0 1.9.1 3.5.0	OFF 3 °C/h	OFF: Function inactive ON: Control when delay decreasing outdoor temperature Function block parameter: Outdoor temperature delay / 1 to 6 °C/h <i>Note: The setting of this function block parameter changes the function parameter in HC1-CO5-06!</i>
06	Delay increasing outdoor temperature	Not Anl. 1.9.0 1.9.1 3.5.0	OFF 3 °C/h	OFF: Function inactive ON: Control when delay increasing outdoor temperature Function block parameter: Outdoor temperature delay / 1 to 6 °C/h <i>Note: The setting of this function block parameter changes the function parameter in HC1-CO5-05!</i>
07	Outdoor temperature 0–10 V at UO1	Not Anl. 1.9.0 1.9.1 3.5.0	OFF –20.0 °C 50.0 °C	OFF: Function inactive ON: Outdoor temperature forwarded at analog output UO1 Function block parameters: Lower transmission range value, outdoor temperature / –30.0 to 100.0 °C Upper transmission range value, outdoor temperature / –30.0 to 100.0 °C

HC1-CO5-	Function	Anl	WE	Comment Function block parameters / Range of values
08	Summer/winter time switchover	All	ON	OFF: Function inactive ON: Automatic summer/winter time switchover
09	Highest priority for frost protection	All	OFF* ON** 3.0 °C	OFF: Restricted frost protection ON: Highest priority for frost protection Function block parameters: Outdoor temperature for frost protection / -15.0 to 3.0 °C * Anl. 1.6.0, 1.6.1, 1.6.2, 1.9.0, 1.9.1 ** Anl. 1.0.0, 1.0.1, 1.1.0, 1.1.1, 1.2.0, 2.0.0, 2.1.0, 2.2.0, 11.0.0, 11.9.0, 11.9.1
10 to 14	Reserved			
15	Unlock controller at S5	All	OFF 1	OFF: Function inactive ON: Unlock controller at S5 depending on switching state Function block parameters: Controller switching state active / 0, 1
16	Return flow limitation by PI algorithm		OFF	OFF: Return flow limitation by P algorithm ON: Return flow limitation by PI algorithm
17	Fault indication output	All	OFF	OFF: Function inactive ON: Error message
18	Demand 0-10 V at UO1	All	OFF 0.0 °C 120.0 °C 0.0 °C	OFF: Function inactive ON: Demand at UO1 active Function block parameters: Lower transmission range value, demand / 0.0 to 130.0 °C Upper transmission range value, demand / 0.0 to 130.0 °C Demand boost / 0.0 to 30.0 °C
19	Temperature monitoring	All	OFF	OFF: Function inactive ON: Temperature monitoring at VS, RS and Rüs



HC1- CO5-	Function	Anl	WE	Comment Function block parameters / Range of values
20 21	Reserved			
22	Lock manual level	All	OFF	OFF: Function inactive ON: Manual level locked

13.2 Parameter levels

Heating circuit HC1

Compact version: Anl. 1.0.0, 1.0.1, 3.5.0 (= All HC1)

Standard version: Anl. 1.0.0, 1.0.1, 1.1.0, 1.1.1, 1.2.0, 2.0.0, 2.1.0, 2.2.0, 3.5.0, 11.0.0, 11.9.0, 11.9.1 (= All HC1)

HC1-PA1	Parameters	Anl	WE	Setting range
01	Flow gradient; only when <ul style="list-style-type: none"> • HC1-CO1-11 = OFF (gradient characteristic) with HC1-CO1-05 = OFF with HC1-CO1-05 = ON 	All HC1	1.4 1.0	0.2 to 3.2 0.2 to 1.0
02	Level gradient; only when <ul style="list-style-type: none"> • HC1-CO1-11 = OFF (gradient characteristic) 	All HC1	0.0 °C	-30.0 to 30.0 °C
03	Flow set point (day); only when <ul style="list-style-type: none"> • HC1-CO1-01 = ON (active room sensor) • HC1-CO1-02 = OFF (fixed set point control) • HC1-CO1-09 = ON (active flash adaptation) 	All HC1	50.0 °C	5.0 to 130.0 °C
04	Flow set point (night); only when <ul style="list-style-type: none"> • HC1-CO1-01 = ON (active room sensor) • HC1-CO1-02 = OFF (fixed set point control) • HC1-CO1-09 = ON (active flash adaptation) 	All HC1	30.0 °C	5.0 to 130.0 °C
05	Parameters of four-point characteristic; only when <ul style="list-style-type: none"> • HC1-CO1-11 = ON (four-point characteristic) <p>Outdoor temperature  Point 1 Point 2 Point 3 Point 4</p> <p>Flow temperature  Point 1 Point 2 Point 3 Point 4</p> <p>Reduced flow temperature  Point 1 Point 2 Point 3 Point 4</p>	All HC1	-15.0 °C -5.0 °C 5.0 °C 15.0 °C 70.0 °C 55.0 °C 40.0 °C 25.0 °C 60.0 °C 40.0 °C 20.0 °C 20.0 °C	-30.0 to 50.0 °C 5.0 to 130.0 °C 5.0 to 130.0 °C

HC1-PA1	Parameters	Anl	WE	Setting range
05	Return flow temperature  Point 1 Point 2 Point 3 Point 4	All ^{HC1}	65.0 °C 65.0 °C 65.0 °C 65.0 °C	5.0 to 90.0 °C
06	Min. flow temperature	All ^{HC1}	20.0 °C	5.0 to 130.0 °C
07	Max. flow temperature with HC1-CO1-05 = OFF with HC1-CO1-05 = ON	All ^{HC1}	90.0 °C 50.0 °C	5.0 to 130.0 °C 5.0 to 50.0 °C
08	Night set-back, flow	All ^{HC1}	10.0 K	0.0 to 50.0 K
09	Outdoor temperature for continuous rated operation (day)	All ^{HC1}	-15.0 °C	-20.0 to 5.0 °C
10	Min. flow set point in heating circuit with active binary demand	All ^{HC1}	40.0 °C	5.0 to 130.0 °C
11	Return flow gradient	All ^{HC1}	1.0	0.2 to 3.2
12	Return flow level	All ^{HC1}	0.0 °C	-30.0 to 0.0 °C
13	Return flow temperature foot	All ^{HC1}	65.0 °C	5.0 to 90.0 °C
14	Max. return flow temperature	All ^{HC1}	65.0 °C	5.0 to 90.0 °C
15	Set point boost of pre-control loop	All ^{HC1}	5.0 °C	0.0 to 50.0 °C

DHW heating

Compact version: Anl. 1.9.0, 1.9.1 (= all DHW)

Standard version: Anl. 1.1.1, 1.2.0, 1.6.0, 1.6.1, 1.6.2, 1.9.0, 1.9.1, 2.0.0, 2.1.0, 2.2.0, 11.0.0, 11.9.0, 11.9.1 (= alle DHW)

DHW-PA4	Parameters	Anl	WE	Setting range
01	Min. adjustable DHW set point	All ^{DHW}	40.0 °C	5.0 to 90.0 °C
02	Max. adjustable DHW set point	All ^{DHW}	60.0 °C	5.0 to 90.0 °C
03	Hysteresis	Not Anl. 1.9.0 1.9.1 11.0.0 11.9.0 11.9.1	5.0 °C	1.0 to 30.0 °C
04	Charging temperature boost	Not Anl. 1.9.0 1.9.1 11.0.0 11.9.0 11.9.1	10.0 °C	0.0 to 50.0 °C
05	Max. charging temperature	Only Anl. 1.6.1 1.6.2 2.2.0	80.0 °C	20.0 to 130.0 °C
06	Lag time of storage tank charging pump	Not Anl. 1.9.0 1.9.1 11.0.0 11.9.0	90 s	0 to 600 s
07	Max. return flow temperature	Not Anl. 2.0.0 2.1.0 2.2.0	65.0 °C	20.0 to 90.0 °C

Web module

Compact/standard version: All systems, provided the TROVIS 5610 Heating Controller is fitted with a web module. Refer to EB 5610-1 EN (Web Module and TROVIS MOBILE Web Application)

PA6	Parameter	Anl	WE	Setting range
01 to 09	Reserved			
10	COM reset	All	0	0, 1
	NOTICE If the parameter is switched from '0' to '1', the user name and password for the TROVIS MOBILE web application are reset to their default settings.			

13.3 Sensor resistance tables

Resistance values with Pt 1000 resistors

- ▶ For Type 5227-2 Outdoor Temperature Sensor
- ▶ For Type 5277-2 Flow, Return Flow and Storage Tank Temperature Sensor (thermowell required) and Type 5267-2 (contact sensor)
- ▶ For Type 5257-5 Room Temperature Sensor (room panel).

°C	-35	-30	-25	-20	-15	-10	-5	0	5	10
Ω	862.5	882.2	901.9	921.6	941.2	960.9	980.4	1000.0	1019.5	1039.0
°C	15	20	25	30	35	40	45	50	55	60
Ω	1058.5	1077.9	1097.3	1116.7	1136.1	1155.4	1174.7	1194.0	1213.2	1232.4
°C	65	70	75	80	85	90	95	100	105	110
Ω	1251.6	1270.7	1289.8	1308.9	1328.0	1347.0	1366.0	1385.0	1403.9	1422.9
°C	115	120	125	130	135	140	145	150		
Ω	1441.7	1460.6	1479.4	1498.2	1517.0	1535.8	1554.5	1573.1		

13.4 Technical data

Inputs	
Compact version	5 inputs for Pt 1000 temperature sensors, alternatively, binary inputs for enabling a control circuit, demand processing, flow switch
Standard version	8 inputs for Pt 1000 temperature sensors, alternatively, binary inputs for enabling a control circuit, demand processing, flow switch 2 0 to 10 V inputs for demand processing, external set point correction, measured outdoor temperature
Outputs	
Compact version	3 relay outputs 230 V AC, 2 A: 1 x control signal output M1 (three-step or on/off) 1 x binary output for a pump
Standard version	2 0 to 10 V outputs for demand, measured outdoor temperature, control signals 7 relay outputs 230 V AC, 2 A: 1 x control signal output M1 (three-step or on/off) 4 x binary outputs for pumps, fault indication or demand or 2 x control signal outputs M1 and M2 (three-step or on/off) 3 x binary outputs for pumps, fault indication or demand
Interfaces	1 slot for optional interface boards
Operating voltage	90 to 253 V AC
Power consumption	Compact version: max. 2.8 VA Standard version: max. 4.0 VA
Ambient temperature	0 to 50 °C (operation), -20 °C to 70 °C (storage and transport)
Relative humidity	5 to 95 %, no dew formation
Degree of protection	Without seal for panel mounting: IP 40 according to IEC 60529 With seal for panel mounting: IP 41 according to IEC 60529
Class of protection	I according to IEC 61140
Degree of contamination	2 according to IEC 60730
Overvoltage category	III according to IEC 60730
Noise immunity	According to IEC 61000-6-1
Noise emission	According to IEC 61000-6-3
Dimensions W x H x D	Approx. 147 x 96 x 49 mm
Weight	Approx. 0.4 kg

13.5 Customer data

Station	
Operator	
SAMSON office	
System code number	

Function block settings in the configuration level

	HC1-CO1	DHW-CO4	HC1-CO5
01			
02			
03			
04			
05			
06			
07			
08			
09			
10			
11			
12			
13			
14			
15			
16			
17			
18			
19			
20			
21			
22			

Heating circuit HC1

HC1-PA1		Range
01	Flow gradient	0.2 to 3.2
02	Flow level	-30.0 to 30.0 °C
03	Flow set point (day)	5.0 to 130.0 °C
04	Flow set point (night)	5.0 to 130.0 °C
05	Parameters of four-point characteristic	
	Outdoor temperature, point 1	-30.0 to 50.0 °C
	Outdoor temperature, point 2	-30.0 to 50.0 °C
	Outdoor temperature, point 3	-30.0 to 50.0 °C
	Outdoor temperature, point 4	-30.0 to 50.0 °C
	Flow temperature, point 1	5.0 to 130.0 °C
	Flow temperature, point 2	5.0 to 130.0 °C
	Flow temperature, point 3	5.0 to 130.0 °C
	Flow temperature, point 4	5.0 to 130.0 °C
	Reduced flow temperature, point 1	5.0 to 130.0 °C
	Reduced flow temperature, point 2	5.0 to 130.0 °C
	Reduced flow temperature, point 3	5.0 to 130.0 °C
	Reduced flow temperature, point 4	5.0 to 130.0 °C
	Return flow temperature, point 1	5.0 to 90.0 °C
	Return flow temperature, point 2	5.0 to 90.0 °C
	Return flow temperature, point 3	5.0 to 90.0 °C
	Return flow temperature, point 4	5.0 to 90.0 °C
06	Min. flow temperature	5.0 to 90.0 °C
07	Max. flow temperature	5.0 to 130.0 °C
08	Night set-back, flow	0.0 to 50.0 K
09	Outdoor temperature for continuous rated operation (day)	-20.0 to 5.0 K
10	Min. flow set point in heating circuit with active binary demand	5.0 to 130.0 °C

HC1-PA1		Range
11	Return flow gradient	0.2 to 3.2
12	Return flow level	-30.0 to 0.0 °C
13	Return flow temperature foot	5.0 to 90.0 °C
14	Max. return flow temperature	5.0 to 90.0 °C
15	Set point boost of pre-control loop	0.0 to 50.0 °C
Function block parameters HC1-CO1		
03-01	Limiting factor	0.1 to 10.0
04-07	Lower transmission range value, outdoor temperature	-30.0 to 100.0 °C
04-08	Upper transmission range value, outdoor temperature	-30.0 to 100.0 °C
05-04	Start temperature for drying of jointless floors	20.0 to 60.0 °C
05-05	Temperature increase for drying of jointless floors	1.0 to 10.0 °C/day
05-06	Max. temperature for drying of jointless floors	2.0 to 60.0 °C
05-07	Max. temperature sustaining time for drying of jointless floors	1 to 10 days
05-08	Temperature reduction for drying of jointless floors	0.0 to 10.0 °C/day
06-10	Preheating time	0 to 360 min
08-10	Preheating time	0 to 360 min
09-11	Cycle time	0 to 100 min
09-12	Gain	0.0 to 25.0
12-18	Hysteresis	2.0 to 10.0 °C
12-19	Min. ON time	0 to 600 s
12-20	Min. OFF time	0 to 600 s
12-13	Gain KP	0.1 to 50.0
12-14	Reset time TN	0 to 999 s
12-15	Derivative-action time TV	0 to 999 s
12-16	Valve transit time TY-OPEN	10 to 240 s

HC1-PA1		Range
13-21	Max. system deviation	2.0 to 10.0 °C
14-22	Control loop 1 switching state active	0, 1
17-23	Demand switching state active	0, 1

DHW heating

DHW-PA4		Range
01	Min. adjustable DHW set point	5.0 to 90.0 °C
02	Max. adjustable DHW set point	5.0 to 90.0 °C
03	Hysteresis	1.0 to 30.0 °C
04	Charging temperature boost	20.0 to 50.0 °C
05	Max. charging temperature	20.0 to 130.0 °C
06	Lag time of storage tank charging pump	0 to 600 s
07	Max. return flow temperature	20.0 to 90.0 °C
Function block parameters DHW-CO4		
03-01	Limiting factor	0.1 to 10.0
06-03	Delay of cancelation due to system deviation	0 to 10 min
06-04	Min. flow set point in heating circuit for parallel pump operation	20.0 to 90.0 °C
08-05	Delay of reverse control active	0 to 10 min
08-06	Correction factor	0.1 to 1.0
09-07	Delay of set-back operation active	0 to 10 min
12-13	Hysteresis	2.0 to 10.0 °C
12-14	Min. ON time	0 to 600 s
12-15	Min. OFF time	0 to 600 s
12-08	Gain KP	0.1 to 50.0
12-09	Reset time TN	0 to 999 s
12-10	Derivative-action time TV	0 to 999 s
12-11	Valve transit time TY-OPEN	10 to 240 s
13-16	Max. system deviation	2.0 to 10.0 °C

DHW-PA4		Range
14-17	Day of week for thermal disinfection	1 to 10
14-18	Start time for thermal disinfection	00:00 to 23:45 h
14-19	Stop time for thermal disinfection	00:00 to 23:45 h
14-20	Disinfection temperature	60.0 to 90.0 °C
14-22	Disinfection temperature boost	0.0 to 5.0 °C
14-21	Disinfection temperature sustaining time	0 to 255 min
14-23	Switching state of control circuit 2 active	0, 1

System-wide HC1

Function block parameters HC1-CO5		Range
04-01	Earliest start date for summer mode	User-definable
04-02	Delay of summer mode active	1 to 3 days
04-03	Latest start date for summer mode	User-definable
04-04	Delay of heating mode active	1 to 3 days
04-05	Outdoor temperature for summer mode	0.0 to 30.0 °C
05-06	Outdoor temperature delay	1 to 6 °C/h
06-06	Outdoor temperature delay	1 to 6 °C/h
07-07	Lower transmission range value, outdoor temperature	-30.0 to 100.0 °C
07-08	Upper transmission range value, outdoor temperature	-30.0 to 100.0 °C
09-09	Outdoor temperature for frost protection	-15.0 to 3.0 °C
15-10	Controller switching state active	0, 1
18-11	Lower transmission range value, demand	0.0 to 130.0 °C
18-12	Upper transmission range value, demand	0.0 to 130.0 °C
18-13	Demand boost	0.0 to 30.0 °C

Index

A

Adaptation	65
Attenuation	
motorized valve	81
Automatic summer time/winter time switchover	79

C

Characteristic	52
Circulation pump	73
CO level	29, 98, 107
Collective fault alarm	89
Condensate accumulation control	81
Configuration level	31, 98, 107
Connection	
actuators	93
controller	92
pumps	93
sensors	93
Continuous rated operation (day)	60
Controller versions	2
Customer data	114, 118

D

Day set point	54
Deactivation based on outdoor temperature	59
Deactivation values	
HC	59
Delayed outdoor temperature adaptation	61
Demand	85
DHW heating	
in instantaneous heating system	73
in the storage tank charging system	69
in the storage tank system	67
time-controlled switchover of storage tank sensors	68, 70
DHW storage tank	
forced charging	77
thermal disinfection	77

Display

brightness	24
calibration	26
cleaning	27
contrast	24
Drying of jointless floors	58

E

Electrical connection	92 - 95
External demand	84
0 to 10 V signal	85
binary signal	84

F

Fixed set point control	57
Flash adaptation	64 - 65
based on room temperature	65
Forced charging, DHW storage tank	77
Forced operation of the pumps	80
Forwarding	
measured outdoor temperature	85
Four-point characteristic	56
Frost protection	79

G

Gradient characteristic	52 - 53
-----------------------------------	---------

H

Heating characteristic	52
----------------------------------	----

I

Installation	90 - 91
Interfaces	96 - 97
Intermediate heating operation	74

J

Jointless floors, drying	58
------------------------------------	----

L

Locking the manual level	86
------------------------------------	----

M

Malfunctions	87 - 89
------------------------	---------

Manual level lock	86	Reverse control	75
Manual mode	18 - 19, 32 - 33	S	
Memory pen	97	Sensor failure	88
Menu		Sensors	
Information	10	Pt 1000	61
Operate	13	Set point correction (heating circuit)	66
Times-of-use	17	Set points	
N		DHW	22
Night set point	54	HC1	22
O		Set-back operation	76
On/off control	82	Setup settings	17, 20 - 31
Operating mode	14	Special times-of-use	15
Operation	8 - 16, 19	Special use	15
Operational faults	87 - 89	Start-up	6
Operator keys	9	Summer mode	60
Optimization (heating circuit)		Summer time/winter time changeover	79
based on outdoor and room		System code number	29
temperature	63	System date and time	25
based on outdoor temperature	62	Systems	34 - 51
based on room temperature	62	T	
Overvoltage protection	92	Technical data	113
P		Temperature monitoring	88
PA level	31, 108, 110	Three-step control	82
Parallel operation, pumps	74	Times-of-use	17
Parameter level	108, 110	TROVIS-VIEW	97
Priority		U	
DHW heating	75	Underfloor heating	58
Processing an external demand	84	Unlocking a control circuit by a binary input	83
0 to 10 V signal	85	Unlocking controller by a binary input	83
binary signal	84	W	
R		Weather-compensated control	52
Remote operation	61	four-point characteristic	56
Resistance values	112	gradient characteristic	53
Return flow temperature limitation	80		

Key number

1732

System	Version	Outdoor temp. measurement (0 to 10 V) with HC1-CO1-04 = ON																
		Unlock control loop 1 with HC1-CO1-14 = ON			Set point correction (0 to 10 V) with HC1-CO1-15 = ON			Demand processing (0 to 10 V) with HC1-CO1-16 = ON			Binary demand processing with HC1-CO1-17 = ON							
		Binary demand with default setting (WE)																
		Storage tank thermostat with DHW-CO4-01 = OFF																
		Thermal disinfection by external demand with DHW-CO4-14 = ON, 9 or 10 and DHW-CO4-17 = ON																
		'Thermal disinfection active' message with DHW-CO4-15 = ON																
		Release control circuit 2 with DHW-CO4-21 = ON																
		Control signal (0 to 10 V) with default setting (WE)																
		Control signal HC (0 to 10 V) with default setting (WE)																
		Control signal DHW (0 to 10 V) with default setting (WE)																
		Forward outdoor temperature (0 to 10 V) with HC1-CO5-07 = ON																
		Unlock controller with HC1-CO5-15 = ON																
		Error message with HC1-CO5-17 = ON																
		Demand (0 to 10 V) with HC1-CO5-18 = ON																
1.0.0	Compact		S5			S4										S5		
	Standard	U11	S5	U12	U11	S4	M2-					UO1			UO1	S5	M2-	UO1
1.0.1	Compact		S5			S4										S5		
	Standard	U11	S5	U12	U11	S4	M2-					UO1			UO1	S5	M2-	UO1
1.1.0	Standard	U11	S5	U12	U11	S8	P3	S7	S4	P3		UO1			UO1	S5	P3	UO1
1.1.1	Standard	U11	S5	U12	U11	S8	M2-	S7	S4	M2-		UO1			UO1	S5	M2-	UO1
1.2.0	Standard	U11	S5	U12	U11	S8	M2-	S7	S4	M2-		UO1			UO1	S5	M2-	UO1
1.6.0	Standard	U11	S5		U11	S8	M2-	S7	S4	M2-		UO1			UO1	S5	M2-	UO1
1.6.1	Standard	U11	S5		U11	S8	M2-	S7	S4	M2-		UO1			UO1	S5	M2-	UO1
1.6.2	Standard	U11	S5		U11	S8	M2-	S7	S4	M2-		UO1			UO1	S5	M2-	UO1
1.9.0	Compact															S5		
	Standard											UO1				S5	M2-	
1.9.1	Compact								S4							S5		
	Standard								S4	M2-		UO1				S5	M2-	
2.0.0	Standard	U11	S5	U12	U11	S8	P3	S7	S4	P3		UO1			UO1	S5	P3	UO1
2.1.0	Standard	U11	S5	U12	U11	S8	M2-	S7	S4	M2-		UO1			UO1	S5	M2-	UO1
2.2.0	Standard	U11	S5	U12	U11	S8	M2-	S7	S4	M2-		UO1			UO1	S5	M2-	UO1
3.5.0	Compact		S5			S4										S5		
	Standard		S5		U11	S4	M2-					UO1				S5	M2-	
11.0.0	Standard	U11	S5	U12	U11	S8	M2-		S4	M2-	S8		UO1	UO2	UO1	S5	M2-	UO1
11.2.0	Standard	U11	S5	U12	U11	S8	M2-	S7	S4	M2-	S8		UO1	UO2	UO1	S5	M2-	UO1
11.9.0	Standard	U11	S5	U11	U11	S8	M2-				S8		UO1	UO2	UO1	S5	P3	UO1
11.9.1	Standard	U11	S5	U11	U11	S4	M2-						UO1	UO2	UO1	S5	M2-	UO1



SAMSON AG · MESS- UND REGELTECHNIK
Weismüllerstraße 3 · 60314 Frankfurt am Main
Phone: +49 69 4009-0 · Fax: +49 69 4009-1507
Internet: <http://www.samson.de>

EB 5610 EN

2014-01