

Application

Vent plugs are screwed into the exhaust air ports of pneumatic, electropneumatic, and electric devices. They ensure that any exhaust air that forms can be vented to the atmosphere (to avoid excess pressure in the device). Furthermore, the vent plugs allow air intake to prevent a vacuum from forming in the device.

The functional reliability must also be kept even during rough environmental conditions. Additionally, the vent plugs prevent

dirt and moisture entering the device. To meet special requirements, check valves can be used to allow air to pass through in only one direction.

i Note

The sensitiveness to impact of vent plugs made of PA/PC increases at temperatures below $-20\text{ }^{\circ}\text{C}$.

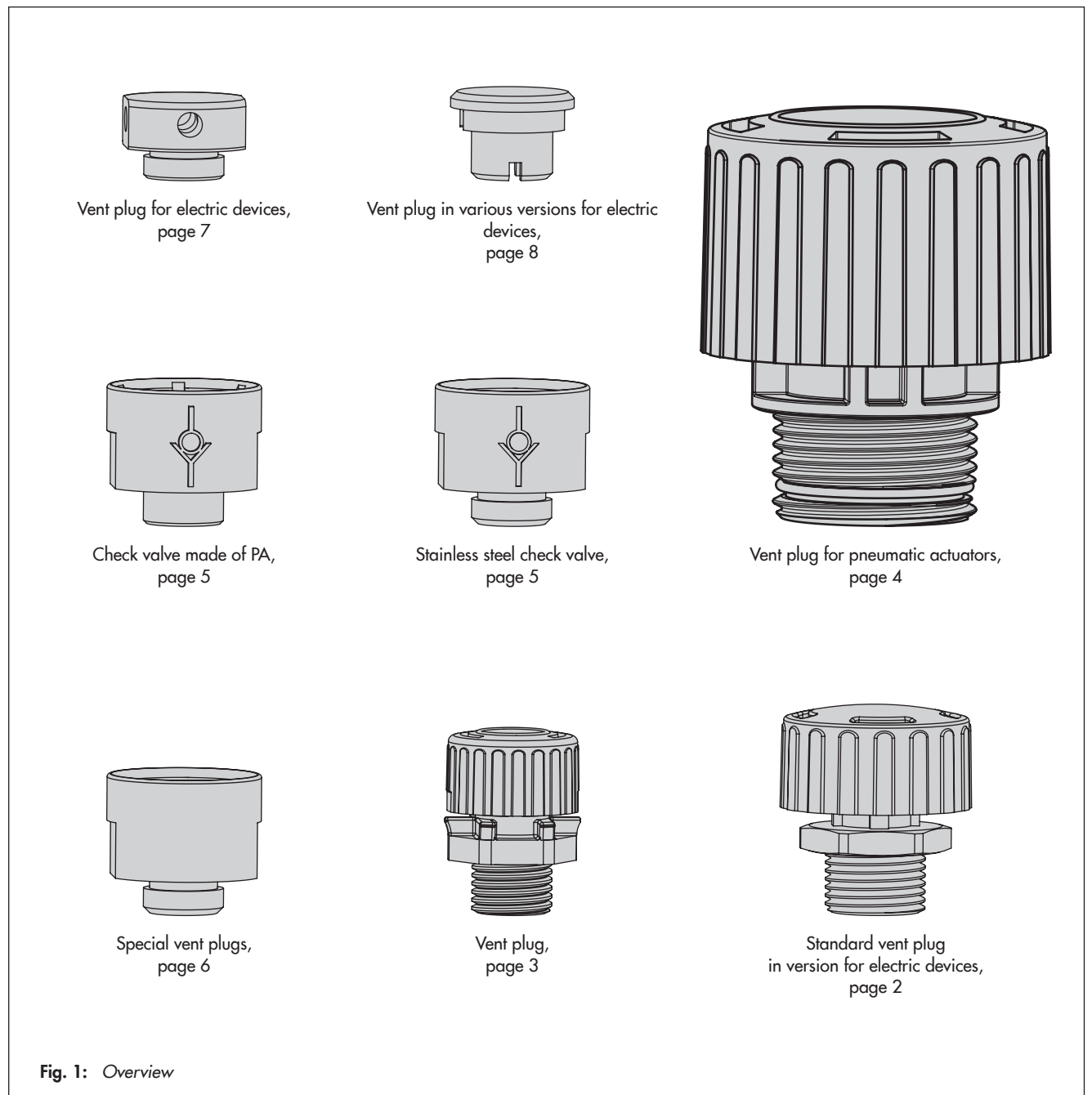

Fig. 1: Overview

Standard vent plug including version for electric devices

Application

The vent plugs (1990-1714 and 1990-1715) are designed for the exhaust air port of pneumatic actuators and other devices. The vent plug (1991-0451) can be used for electric or electropneumatic devices.

NOTICE

- The vent plug (1991-0451) is designed only for a small difference pressure and a low air capacity. Therefore, it must not be subjected to a pressure higher than the specified exhaust air pressure p_A .
- Influences, such as vibrations and changes in temperature, may cause the vent plug to become loose. In this case, we recommend taking appropriate precautions, e.g. by using sealing tape or thread-locking fluid which is compatible with plastic.
- Make sure that the surrounding medium cannot enter the vent plug and that the vent plug cannot get blocked due to the formation of ice or layers of dust.

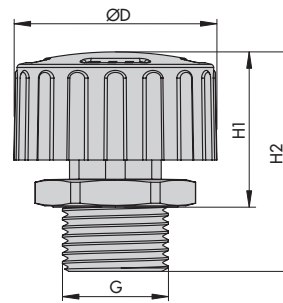

Fig. 2: Vent plug (1990-1715)

Technical data

Order no.	1990-1714	1990-1715	1991-0451
Type	Vent plug	Vent plug	Vent plug for electric devices
Material	PA	PA	PA
Medium	Instrument air	Instrument air	Instrument air
Exhaust air pressure p_A	6 bar	6 bar	≤ 1 bar
K_{VS}	1.2	1.2	0.7
Ambient temperature	-60 to +80 °C	-60 to +80 °C	-60 to +80 °C
Degree of protection	IP 54	IP 54	IP 66
Tightening torque	≤ 4 Nm	≤ 4 Nm	≤ 4 Nm
Dimensions and weights			
Connecting thread G	G 1/4 ¹⁾	G 3/8 ¹⁾	G 1/4 ¹⁾
Outside diameter ØD	31 mm	31 mm	31 mm
Height H1	23 mm	23 mm	23 mm
Height H2	33.5 mm	33.5 mm	33.5 mm
Weight	Approx. 9 g	Approx. 10 g	Approx. 10 g
Packaging unit (10 pcs.)	1402-1329	1402-1330	-
Logic symbol			

¹⁾ Also fitting NPT connections

Vent plug

Application

The vent plug is designed for the exhaust air port of pneumatic devices.

NOTICE

- The vent plugs must not be subjected to a pressure higher than the specified exhaust air pressure p_A .
- Influences, such as vibrations and changes in temperature, may cause the vent plug to become loose. In this case, we recommend taking appropriate precautions, e.g. by using sealing tape or thread-locking fluid which is compatible with plastic.
- Make sure that the surrounding medium cannot enter the vent plug and that the vent plug cannot get blocked due to the formation of ice or layers of dust.

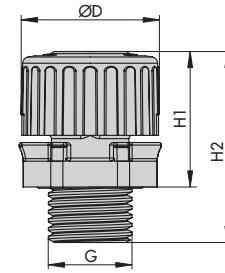

Fig. 3: Vent plug (1992-3966)

Technical data

Order no.	1992-3965	1992-3966
Type	Vent plug	Vent plug
Material	PA	PA
Medium	Instrument air	Instrument air
Exhaust air pressure p_A	6 bar	6 bar
K_{vs}	0.75	1.1
Ambient temperature	-60 to +80 °C	-60 to +80 °C
Degree of protection	IP 54	IP 54
Tightening torque	≤4 Nm	≤4 Nm
Dimensions and weights		
Connecting thread G	G 1/8 ¹⁾	G 1/4 ¹⁾
Outside diameter ØD	22 mm	22 mm
Height H1	21 mm	21 mm
Height H2	30 mm	30 mm
Weight	Approx. 6 g	Approx. 6 g
Packaging unit (10 pcs.)	1402-1327	1402-1328
Logic symbol		

¹⁾ Also fitting NPT connections

Vent plugs for pneumatic actuators

Application

The vent plugs are designed for the exhaust air port of large pneumatic actuators due to the comparatively high K_{VS} coefficient.

NOTICE

- The vent plugs must not be subjected to a pressure higher than the specified exhaust air pressure p_A .
- Influences, such as vibrations and changes in temperature, may cause the vent plug to become loose. In this case, we recommend taking appropriate precautions, e.g. by using sealing tape or thread-locking fluid which is compatible with plastic.
- Make sure that the surrounding medium cannot enter the vent plug and that the vent plug cannot get blocked due to the formation of ice or layers of dust.

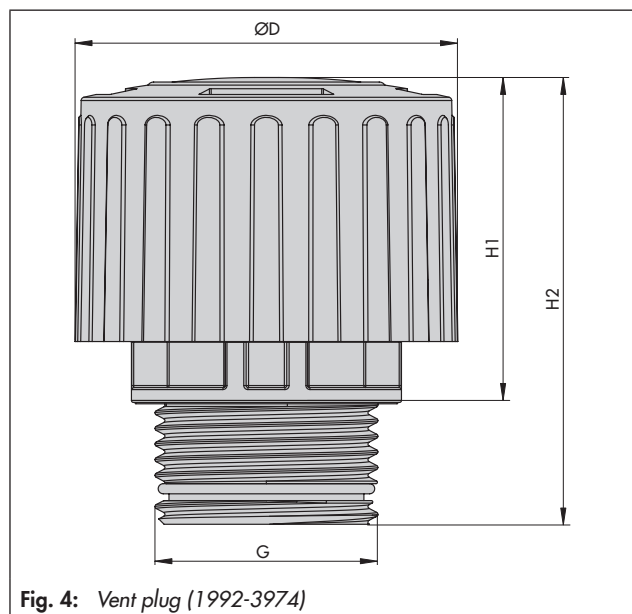

Fig. 4: Vent plug (1992-3974)

Technical data

Order no.	1992-3974	1992-3976	1992-3975	1992-3977	1992-3413
Type	Vent plug for actuators	Vent plug for actuators	Vent plug for actuators	Vent plug for actuators	Vent plug for actuators
Material	PC	PC/stainless steel	PC	PC/stainless steel	PC
Medium	Instrument air	Instrument air	Instrument air	Instrument air	Instrument air
Exhaust air pressure p_A	6 bar	6 bar	6 bar	6 bar	6 bar
K_{VS}	10	10	9.4	9.4	4.5
Ambient temperature	-60 to +80 °C	-60 to +80 °C	-60 to +80 °C	-60 to +80 °C	-60 to +80 °C
Degree of protection	IP 54	IP 54	IP 54	IP 54	IP 54
Tightening torque	≤4 Nm	≤4 Nm	≤4 Nm	≤4 Nm	≤4 Nm
Dimensions and weights					
Connecting thread G	G 1	1 NPT	G ¾	¾ NPT	G ½
Outside diameter ØD	56.5 mm	56.5 mm	56.5 mm	56.5 mm	56.5 mm
Height H1	48 mm	70 mm	48 mm	68 mm	48 mm
Height H2	66 mm	95 mm	64 mm	88 mm	62 mm
Weight	Approx. 66 g	Approx. 115 g	Approx. 66 g	Approx. 115 g	Approx. 66 g
Logic symbol					

Check valve

Application

The check valves can be used with the following devices:

- Solenoid valves
- Reversing amplifiers
- i/p converters
- p/i converters
- Pneumatic positioners
- Electropneumatic positioners
- Limit switches

The check valves are not suitable for use in the exhaust air ports of pneumatic actuators.

NOTICE

- The check valves must only be used in cases where the check valves do not cause the backpressure to impair the functioning of the device.
- Check valves are not able to take on the function of venting and air intake at the same time.
- Influences, such as vibrations and changes in temperature, may cause the check valve to become loose. In this case, we recommend taking appropriate precautions, e.g by using sealing tape or thread-locking fluid which is compatible with material.
- Make sure that the surrounding medium cannot enter the vent plug and that the vent plug cannot get blocked due to the formation of ice or layers of dust.

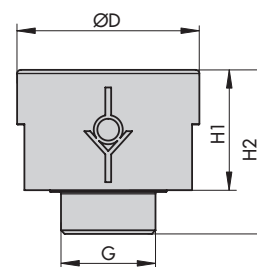

Fig. 5a: Check valve (1790-7408 and 1790-9645)

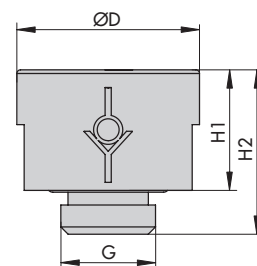

Fig. 5b: Check valve (1790-7253 and 1790-9646)

Fig. 5: Check valves

Technical data

Order no.	1790-7408	1790-9645	1790-7253	1790-9646
Type	Check valve	Check valve	Check valve	Check valve
Material	Bodies	PA	Stainless steel	Stainless steel
	Filter disk	PE	PE	PE
Medium	Instrument air, free from corrosive substances	Instrument air, free from corrosive substances	Instrument air	Instrument air
Exhaust air pressure p_A	≤ 2.5 bar	≤ 2.5 bar	≤ 2.5 bar	≤ 2.5 bar
K_{VS}	1.1	1.1	1.1	1.1
Ambient temperature	-60 to +80 °C	-60 to +80 °C	-60 to +80 °C	-60 to +80 °C
Degree of protection	IP 65	IP 66, NEMA 4	IP 66	NEMA 4
Tightening torque	≤ 4 Nm	≤ 4 Nm	≤ 6 Nm	≤ 6 Nm
Dimensions and weights				
Connecting thread G	G 1/4 ¹⁾	G 1/4 ¹⁾	G 1/4 ¹⁾	G 1/4 ¹⁾
Outside diameter ØD	26 mm	26 mm	25 mm	25 mm
Height H1	16.5 mm	16.5 mm	16.5 mm	16.5 mm
Height H2	22.5 mm	22.5 mm	22.5 mm	22.5 mm
Weight	10 g	10 g	30 g	30 g
Logic symbol				

¹⁾ Also fitting NPT connections

Special vent plugs

Application

The vent plugs (1890-2940 and 1990-7637) can be used for Type 6134 p/i Converter.

NOTICE

- The vent plugs (1890-2904 and 1990-7637) are designed only for a small difference pressure and a low air capacity. Therefore, they must not be subjected to a pressure higher than the specified exhaust air pressure p_A .
- Influences, such as vibrations and changes in temperature, may cause the vent plug to become loose. In this case, we recommend taking appropriate precautions, e.g. by using sealing tape or thread-locking fluid.
- Make sure that the surrounding medium cannot enter the vent plug and that the vent plug cannot get blocked due to the formation of ice or layers of dust.

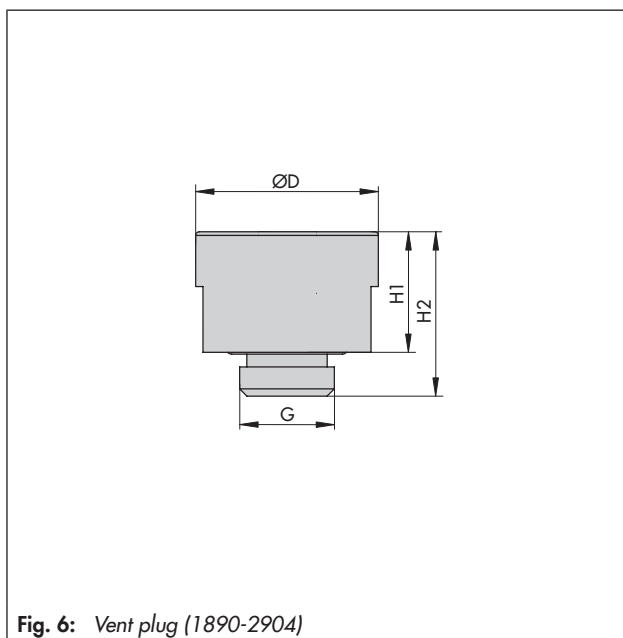

Fig. 6: Vent plug (1890-2904)

Technical data

Order no.	1890-2904	1990-7637 ¹⁾
Type	Vent plug	Vent plug
Material	Bodies	Stainless steel
	Filter disk	PE
Medium	Instrument air	Instrument air
Exhaust air pressure p_A	≤ 2.5 bar	≤ 1.0 bar
K_{VS}	1.1	No details
Ambient temperature	-60 to $+80$ °C	-60 to $+80$ °C
Degree of protection	IP 54	IP 65
Tightening torque	≤ 6 Nm	≤ 6 Nm
Dimensions and weights		
Connecting thread G	G 1/4 ²⁾	G 1/4 ²⁾
Outside diameter ØD	25 mm	25 mm
Height H1	16.5 mm	16.5 mm
Height H2	22.5 mm	22.5 mm
Weight	Approx. 28 g	Approx. 28 g
Logic symbol		

¹⁾ Only suitable for Type 6134 Electropneumatic Converter

²⁾ Also fitting NPT connections

Vent plug for electric devices

Application

NOTICE

- The vent plug is exclusively designed for electric devices and must not be used for pneumatic devices.
- The vent plug (1991-2110) is designed only for a small difference pressure and a low air capacity. Therefore, it must not be subjected to a pressure higher than the specified exhaust air pressure p_A .
- Influences, such as vibrations and changes in temperature, may cause the vent plug to become loose. In this case, we recommend taking appropriate precautions, e.g. by using sealing tape or thread-locking fluid.
- Make sure that the surrounding medium cannot enter the vent plug and that the vent plug cannot get blocked due to the formation of ice or layers of dust.

Note

The vent plug (1991-2110) is only available on request.

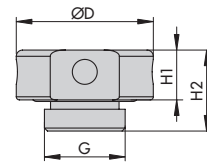

Fig. 7: Vent plug (1991-2110)

Technical data

Order no.	1991-2110
Type	Vent plug for electric devices
Material	1.4404
Medium	Instrument air
Exhaust air pressure p_A	6 bar
Ambient temperature	-60 to +80 °C
Degree of protection	IP 66
Outside diameter	22 mm
Tightening torque	≤6 Nm
Dimensions and weights	
Connecting thread G	G 1/4 ¹⁾
Outside diameter ØD	22 mm
Height H1	8 mm
Height H2	13 mm
Weight	Approx. 22 g
Logic symbol	

¹⁾ Also fitting NPT connections

Vent plug in various versions for electric devices

Application

The vent plug (1690-3110) specially designed for electric devices can be used in positioners, limit switches, position transmitters and similar electropneumatic and electric devices.

NOTICE

- The vent plug (1690-3110) is designed only for a small difference pressure and a low air capacity. Therefore, it must not be subjected to a pressure higher than the specified exhaust air pressure p_A .
- Influences, such as vibrations and changes in temperature, may cause the vent plug to become loose. In this case, we recommend taking appropriate precautions, e.g. by using sealing tape or thread-locking fluid which is compatible with plastic.
- Make sure that the surrounding medium cannot enter the vent plug and that the vent plug cannot get blocked due to the formation of ice or layers of dust.

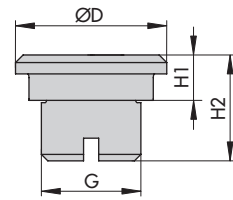

Fig. 8: Vent plug (0070-0773)

Technical data

Order no.	0070-0774	0070-0773	1690-3110
Type	Vent plug	Vent plug	Vent plug for electric devices
Material	PC	PC	PC
Medium	Instrument air	Instrument air	Instrument air
Exhaust air pressure p_A	6 bar	6 bar	≤ 1 bar
K_{VS}	0.6	1.2	No details
Ambient temperature	–60 to +80 °C	–60 to +80 °C	–60 to +80 °C
Degree of protection	IP 42	IP 42	IP 65
Tightening torque	≤4 Nm	≤4 Nm	≤4 Nm
Dimensions and weights			
Connecting thread G	G 1/8 ¹⁾	G 1/4 ¹⁾	G 1/4 ¹⁾
Outside diameter	20 mm	20 mm	20 mm
Height H1	6.5 mm	6.5 mm	6.5 mm
Height H2	13 mm	13 mm	13 mm
Weight	Approx. 3 g	Approx. 3 g	Approx. 3 g
Logic symbol			

¹⁾ Also fitting NPT connections

Venting pipe

Application

The venting pipe is screwed into the threaded connection on the top diaphragm case of pneumatic actuators.

NOTICE

The venting pipe must only be screwed into the threaded connection on the top diaphragm case with the open end of the pipe pointing downward.

Note

An adapter is required to mount the pipe on actuators with 1400-120 cm² or larger (see table).

Selection of a suitable venting pipe

Actuator size	Connection size		Adapter	Venting pipe
175 cm ²	ISO 228-1	G ¼	–	1380-2588
	NPT	¼-18	–	1380-2594
240 cm ²	ISO 228-1	G ¼	–	1380-2588
	NPT	¼-18	–	1380-2594
350 cm ²	ISO 228-1	G ⅜	–	1380-2589
	NPT	⅜-18	–	1380-2595
355 cm ²	ISO 228-1	G ⅜	–	1380-2589
	NPT	⅜-18	–	1380-2595
700 cm ²	ISO 228-1	G ⅜	–	1380-2589
	NPT	⅜-18	–	1380-2595
750 cm ²	ISO 228-1	G ⅜	–	1380-2589
	NPT	⅜-18	–	1380-2595
1000 cm ²	ISO 228-1	G ¾	–	0400-9940
	NPT	¾-14	–	0401-2465
1400-60 cm ²	ISO 228-1	G ¾	–	0400-9940
	NPT	¾-14	–	0401-2465
1400-120 cm ²	ISO 228-1	G 1	8580-1050	0400-9940
2800 cm ²	ISO 228-1	G 1	8580-1050	0400-9940
2 x 2800 cm ²	ISO 228-1	G 1	8580-1050	0400-9940

Specifications subject to change without notice



SAMSON AG · MESS- UND REGELTECHNIK
Weismüllerstraße 3 · 60314 Frankfurt am Main, Germany
Phone: +49 69 4009-0 · Fax: +49 69 4009-1507
samson@samson.de · www.samson.de

AB 07 EN

2017-08-09 · English