

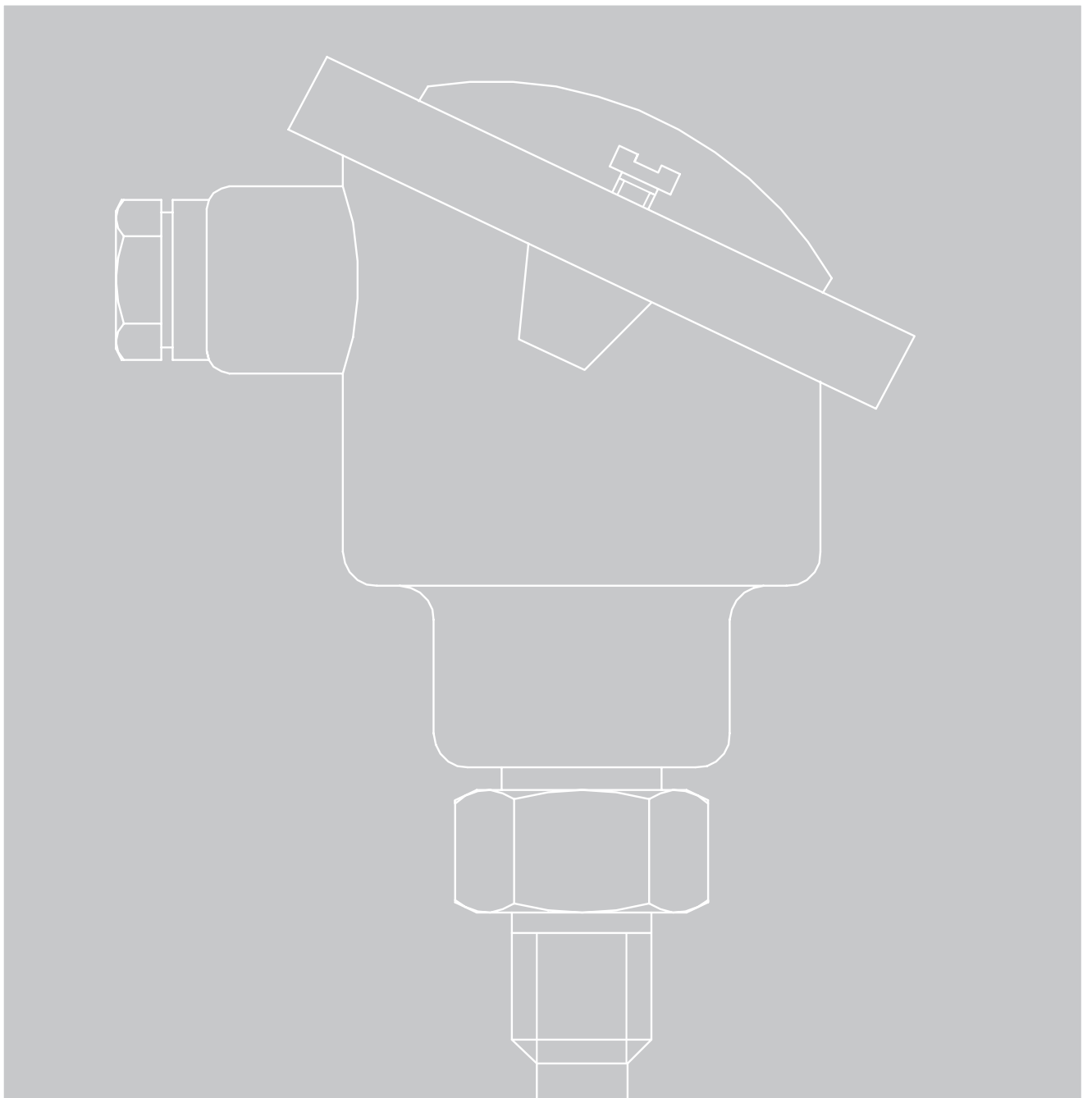



Einsatzgebiet: Heizungs,- Lüftungs- und Klimatechnik





Außensensoren

Messung der Außentemperatur an Gebäudeaußenwänden

Typ	5225	5226	5227-2
Widerstand	Pt 100	Pt 100	Pt 1000
Anzahl	1	2	1
zulässige Temperatur [°C]			
Medium	-20 ... 50	-20 ... 50	-35 ... 85
Umgebung	-35 ... 85	-35 ... 85	-35 ... 85
Bauform			
Typenblatt	T 5203	T 5203	T 5220

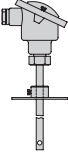
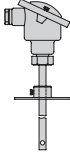

Kanalsensoren

Messung der Zuluft-, Mischluft- und Ablufttemperatur in Lüftungs- und Klimaanlage (nicht aggressive Luft und Gase)

Typ	5215	5216	5217
Widerstand	Pt 100	Pt 100	Pt 1000
Anzahl	1	2	1
Sensorenlänge [mm]	60 ... 300	60 ... 300	60 ... 280
Sensorschaft aus	Ms vern.	Ms vern.	Ms vern.
zulässige Temperatur [°C]			
Medium	-35 ... 200	-35 ... 200	-20 ... 150
Umgebung	-20 ... 70	-20 ... 70	-20 ... 70
Bauform			
Typenblatt	T 5203	T 5203	T 5220

Raumsensoren und Raumleitgeräte

Messung der Raumtemperatur in Aufenthalts- und Arbeitsräumen

Typ	5255	5257-5 ¹⁾	5257-7 ¹⁾
Widerstand	Pt 100	Pt 1000	Pt 1000
Anzahl	1	1	1
zulässiger Temperaturbereich [°C]	-35 ... 85	-20 ... 60	-20 ... 60
Ausstattung			
Sollwertkorrektur und Betriebsartenschalter		•	•
Bauform			
Typenblatt	T 5203	T 5220	T 5220

¹⁾ Anschlussmöglichkeiten an SAMSON-Regler siehe zugehöriges Typenblatt T 5220



Bild 1: Außensensor Typ 5227-2



Bild 2: Raumleitgerät Typ 5257-5

Anlegesensor



Messung der Wassertemperatur im Heizungsvor- und Rücklauf

Typ	5267-2
Widerstand	Pt 1000
Anzahl	1
zulässiger Temperaturbereich [°C]	-20 ... 120
Bauform	
Typenblatt	T 5220

Eintauchsensoren mit Tauchhülse

Messung der Wassertemperatur im Heizungsvor- und Rücklauf, in Warmwasserbereitern und bei wärmetechnischen Anlagen.

Tauchhülse erforderlich.

Typ	5277-2	5277-3, -5
Widerstand	Pt 1000	Pt 1000
Anzahl	1	1
Länge [mm]		
Sensor	50	
Anschlusskabel	2000	3000, 5000
Sensorschaft aus	Ms, CrNiMo	Ms, CrNiMo
Nenndruck	PN 16, PN 40	PN 16, PN 40
zulässiger Temperaturbereich [°C]	-50 ... 180	
Bauform		
Typenblatt	T 5220	T 5220

Schnell ansprechende Temperatursensoren

Temperatursensor mit kurzer Ansprechzeit zur Erfassung schneller Temperaturänderungen in Wärmeübertragern

Typ	5207-0060	5207-61	5207-64	5207-65
Widerstand	Pt 1000	Pt 1000	Pt 1000	Pt 1000
Anzahl	1	1	1	1
Länge [mm]				
Tauchrohr	-	110	170	250
Eintauch~	52	80	40 ... 100	120 ... 190
Anschlusskabel	2000	2500	2500	2500
Nenndruck	PN 16	PN 40	PN 40	PN 40
zulässige Temperatur [°C]				
Medium	-5 ... 90	-50 ... 180	-15 ... 180	-15 ... 180
Umgebung	-5 ... 80	-50 ... 180	-15 ... 180	-15 ... 180
Typenblatt	T 5222	T 5221	T 5221	T 5221



Bild 3: Anlegesensor Typ 5267-2





Bild 4: Eintauchsensoren Typ 5277-2 mit Tauchhülse kurz, lang



Bild 5: Schnell ansprechender Temperatursensor Typ 5207-0060

Einschraubensensoren

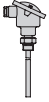
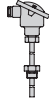
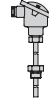
Messung der Wassertemperatur im Heizungsvor- oder Rücklauf, in der Trinkwasserbereitung und bei wärmetechnischen Anlagen

Typ	5204-21 5204-26 5204-27	5205-46 5205-47 5205-48	5206-46 5206-47 5206-48	5207-21 5207-26 5207-27	5207-46 5207-47 5207-48
Widerstand	Pt 100	Pt 100	Pt 100	Pt 1000	Pt 1000
Anzahl	1	1	2	1	1
Sensorlänge					
80 mm	5204-21	–	–	5207-21	–
160 mm	5204-27	5205-47	5206-47	5207-27	5207-47
250 mm	5204-26	5205-46	5206-46	5207-26	5207-46
400 mm	–	5205-48	5206-48	–	5207-48
Sensorschaft aus	Ms ¹⁾	1.4571	1.4571	Ms	1.4571
Nenndruck	PN 16	PN 40	PN 40	PN 16	PN 40
zulässige Temperatur [°C]					
Medium	–20...150	–60...400	–60...400	–20...150	–60...400
Umgebung	–20...70	–20...70	–20...70	–20...70	–20...70
Bauform					
Typenblatt	T 5203	T 5203	T 5203	T 5220	T 5220

¹⁾ Typ 5204-21 auch in 1.4571 und PN 40 erhältlich, siehe T 5203







Bild 6: Einschraubsensor Typ 5205/5206

Thermostate



Typgeprüfte Thermostate zum Einsatz als Temperaturwächter (TW), Sicherheitstempurwächter (STW), Temperaturregler (TR) oder Sicherheitstempurbegrenzer (STB) sowie als Kombination aus Temperaturregler und Sicherheitstempurbegrenzer (TR/STB) oder Temperaturregler und Sicherheitstempurwächter (TR/STW).



Einzelthermostate

Typ	5312-2	5343-1 bis -4	5344-1 und -2	5345-1/-2
Funktion	TW	STW	TR	STB
Sollwertbereich [°C]	-10 ... 12	0 ... 60, 40 ... 100, 70 ... 130 oder -35 ... 95	0 ... 120 oder 20 ... 150	70 ... 130 oder 30 ... 90
Sensormlänge [mm]	6000	100, 150, 200, 300 ¹⁾		
max. Mediumtemperatur [°C]	200	85, 125, 155 oder 120	145 oder 175	155 oder 115
Bauform				
Typenblatt	T 5207	T 5206		

Doppelthermostate

Typ	5347-1/-2	5348-1/-2	5349-1
Funktion	TR/STB	TR/STW	STW/STB
Sollwertbereich [°C]	TR: 0 ... 120 STB: 70 ... 130 oder TR: 0 ... 120 STB: 30 ... 90	TR: 0 ... 120 STW: 70 ... 130 oder TR: 0 ... 120 STW: 40 ... 100	STW: 70 ... 130 STB: 70 ... 130
Sensormlänge [mm]	150, 300 ¹⁾		
max. Mediumtemperatur [°C]	145 oder 115	145 oder 125	145
Bauform			
Typenblatt	T 5206		

Hinweis: Alte SAMSON-Thermostate können gemäß der auf Seite 6 aufgeführten Tabelle gegen die aktuellen SAMSON-Thermostate ausgetauscht werden.

Austausch alter SAMSON-Thermostate gegen aktuelle SAMSON-Thermostate

Funktion	ALT			Tauchhülse	NEU		
	SAMSON-Typ	Var.-ID	Bereich		SAMSON-Typ	Var.-ID	Bereich
STW	5313-4	1008795	0 ... 60 °C	150 x 8 mm, G ½	5343-1	2111650	0 ... 60 °C
	5313-5	1008797	60 ... 100 °C	150 x 8 mm, G ½	5343-2	2111654	40 ... 100 °C
	5313-6	1008796	60 ... 110 °C	150 x 8 mm, G ½	5343-3	2111655	70 ... 130 °C
	5313-7	1008798	60 ... 120 °C	150 x 8 mm, G ½			
	5313-8	1008799	60 ... 130 °C	150 x 8 mm, G ½			
	5313-9	1008801	20 ... 95 °C	300 x 8 mm, CrNiMo	5343-4	2382590	35 ... 95 °C
	5313-10	1008800	50 ... 300 °C	150 x 8 mm, G ½	1)		
TR	5314-1	1008802	20 ... 90 °C	150 x 8 mm, G ½	5344-1	2111657	0 ... 120 °C
	5314-2	1008803	20 ... 90 °C	300 x 8 mm, G ½			
	5314-3	1008804	20 ... 150 °C	100 x 8 mm, G ½	5344-2	2111659	20 ... 150 °C
STB	5315-1	1008805	30 ... 110 °C	150 x 8 mm, G ½	5345-1	2108361	70 ... 130 °C
	5315-2	1008806	60 ... 130 °C	150 x 8 mm, G ½			
	5315-3	1008807	130 ... 200 °C	150 x 8 mm, G ½	1)		
					5345-2	2382592	30 ... 90 °C
TR/STB	5317-2	1008810	30 ... 110 °C	150 x 8 mm, G ½	5347-1	2108363	TR: 0 ... 120 °C STB: 70 ... 130 °C
	5317-3	1008809	20 ... 90 °C	150 x 8 mm, G ½			
	5317-4	1008811	50 ... 120 °C	150 x 8 mm, G ½	5347-2	2821326	TR: 0 ... 120 °C STB: 30 ... 90 °C
	5317-5	1008808	60 ... 130 °C	150 x 8 mm, G ½			
TR/STW	5318-1	1008813	0 ... 70 °C	300 x 8 mm, G ½	1)		
	5318-2	1008814	20 ... 120 °C	150 x 8 mm, G ½	5348-1	2108365	TR: 0 ... 120 °C STW: 70 ... 130 °C
	5318-3	1008815	20 ... 100 °C	150 x 8 mm, G ½			
	5318-4	1008812	20 ... 110 °C	150 x 8 mm, G ½	5348-2	2821369	TR: 0 ... 120 °C STW: 40 ... 100 °C
STW/STB					5349-1	2347423	STW: 70 ... 130 °C STB: 70 ... 130 °C

1) Kein vergleichbares Thermostat im aktuellen Lieferprogramm

Technische Änderungen vorbehalten.



SAMSON AG · MESS- UND REGELTECHNIK
Weismüllerstraße 3 · 60314 Frankfurt am Main
Telefon: 069 4009-0 · Telefax: 069 4009-1507
samson@samson.de · www.samson.de

T 5200

2018-04-04 · German/Deutsch