

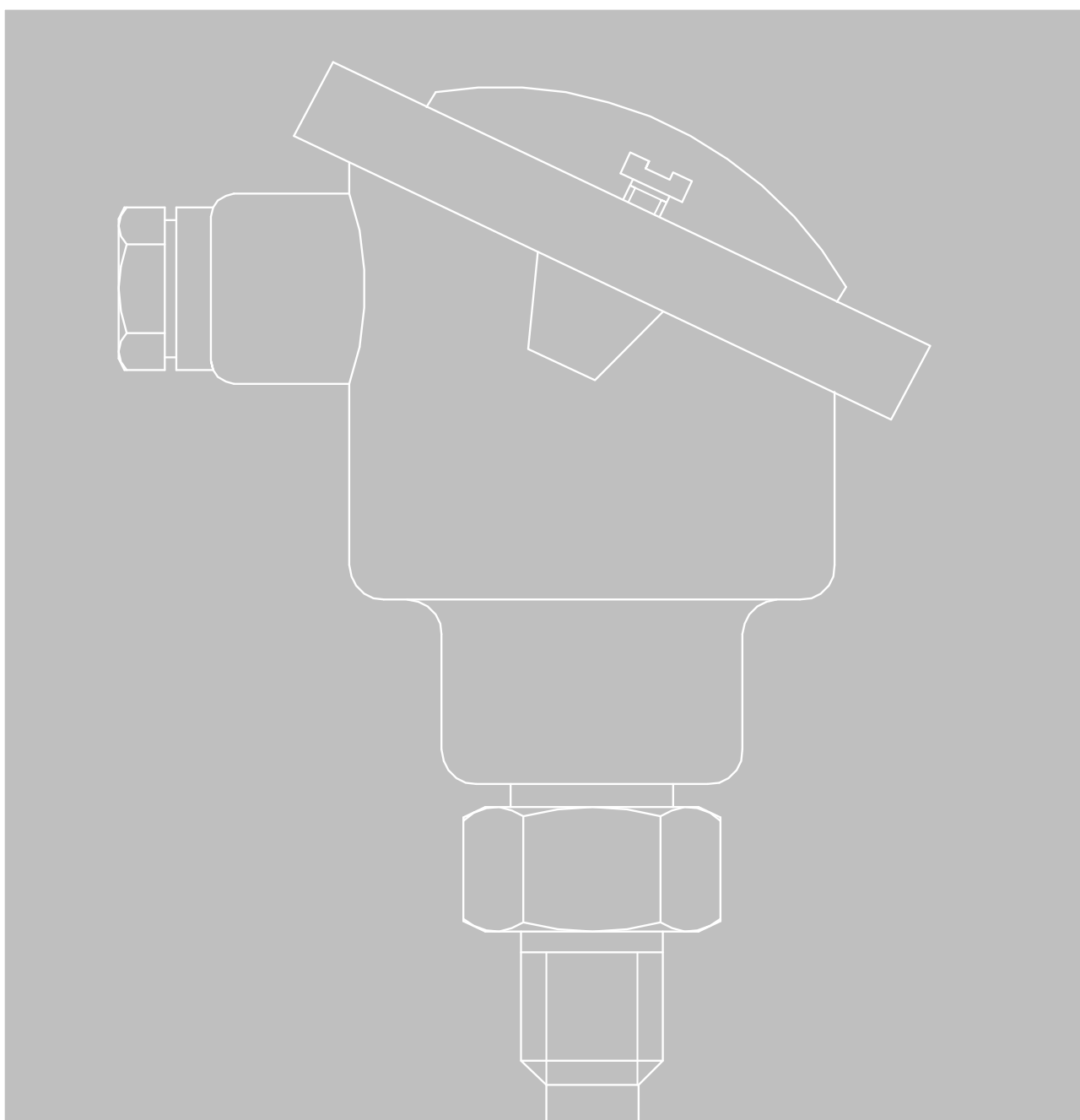



Področje uporabe: ogrevanje, prezračevanje in klimatizacija





Zunanja tipala

Merjenje temperature okolice na zunanjih stenah zgradb

Tip	5225	5226	5227-2
Upor	Pt 100	Pt 100	Pt 1000
Število	1	2	1
Dopustna temperatura [°C]			
Medij	-20 ... 50	-20 ... 50	-35 ... 85
Okolica	-35 ... 85	-35 ... 85	-35 ... 85
Konstruktivska izvedba			
Tipski list	T 5203	T 5203	T 5220

Kanalska tipala

Merjenje temperature dovodnega, mešanega in odpadnega zraka v prezračevalnih in klimatskih sistemih (neagresiven zrak in plini)

Tip	5215	5216	5217
Upor	Pt 100	Pt 100	Pt 1000
Število	1	2	1
Dolž. tipala [mm]	300	300	290
Steblo tipala iz	ponikl. med.	ponikl. med.	ponikl. med.
Dopustna temperatura [°C]			
Medij	-35 ... 200	-35 ... 200	-20 ... 150
Okolica	-20 ... 70	-20 ... 70	-20 ... 70
Konstruktivska izvedba			
Tipski list	T 5203	T 5203	T 5220











Slika 1 · Zunanje tipalo tipa 5227-2



Slika 2 · Sobni upravljalnik tipa 5257-5

Sobna tipala in sobni upravljalniki

Merjenje sobne temperature v bivalnih in delovnih prostorih

Tip	5255	5256	5257-1	5257-2	5257-3	5257-4	5257-5	5257-6	5257-7 ¹⁾
Upor	Pt 100	Pt 100	Pt 1000	Pt 1000	Pt 1000	Pt 1000	Pt 1000	Pt 1000	Pt 1000
Število	1	2	1	1	1	1	1	1	1
Dop. temperaturno območje [°C]	-35 ... 85	-35 ... 85	-35 ... 70	-35 ... 70	-35 ... 70	-35 ... 70	-20 ... 60	-35 ... 70	-20 ... 60
Oprema									
Korekc. zaht. vrednosti				•	•	•	•	•	•
Stikalo za načine obr.						•	•		•
Stopenjsko stikalo								•	
Tipka					•				
Konstruktivska izvedba									
Tipski list	T 5203	T 5203	T 5220	T 5220	T 5220	T 5220	T 5220	T 5220	T 5220

¹⁾ Samo za priključitev na kombinirani regulator s premočrtnim pogonom tipa 5757-7

Naležno tipalo



Merjenje temperature vode v predtoku in povratku ogrevanja

Tip	5267-2
Upor	Pt 1000
Število	1
Dop. temperaturno območje [°C]	-20 ... 120
Konstruktivna izvedba	
Tipski list	T 5220

Potopna tipala s potopno tulko

Merjenje temperature vode v predtoku in povratku ogrevanja, v grelnikih sanitarne vode in pri toplotnih napravah.

Potrebna je potopna tulka.

Tip	5277-2	5277-3, -5
Upor	Pt 1000	Pt 1000
Število	1	1
Dolžina [mm]		
Tipalo	80, 250	80, 250
Priključni kabel	2000	3000, 5000
Steblo tipala iz	med., CrNiMo	med., CrNiMo
Imenski tlak	PN 16, PN 40	PN 16, PN 40
Dop. temperaturno območje [°C]	-10 ... 105	-50 ... 180
Konstruktivna izvedba		
Tipski list	T 5220	T 5220

Temperaturna tipala s hitrim odzivom

Temperaturno tipalo s kratkim odzivnim časom za zajem hitrih temperaturnih sprememb v prenosnikih toplote

Tip	5207-0060	5207-61	5207-64	5207-65
Upor	Pt 1000	Pt 1000	Pt 1000	Pt 1000
Število	1	1	1	1
Dolžina [mm]				
Potopna cev	-	110	170	250
Potopitev	52	80	40 ... 100	120 ... 190
Priključni kabel	2000	2500	2500	2500
Imenski tlak	PN 16	PN 40	PN 40	PN 40
Dopustna temperatura [°C]				
Medij	-5 ... 90	-50 ... 180	-15 ... 180	-15 ... 180
Okolica	-5 ... 80	-50 ... 180	-15 ... 180	-15 ... 180
Tipski list	T 5222	T 5221	T 5221	T 5221



Slika 3 · Naležno tipalo tipa 5267-2





Slika 4 · Potopna tipala tipa 5277-2 s potopno tulko, kratko, dolgo



Slika 5 · Temperaturno tipalo s hitrim odzivom tipa 5207-0060

Uvojna tipala

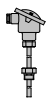
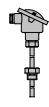
Merjenje temperature vode v predtoku in povratku ogrevanja, v grelnikih sanitarne vode in pri toplotnih napravah

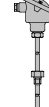
Tip	5204-21 5204-26 5204-27	5205-46 5205-47 5205-48	5206-46 5206-47 5206-48	5207-21 5207-26 5207-27	5207-46 5207-47 5207-48
Upor	Pt 100	Pt 100	Pt 100	Pt 1000	Pt 1000
Število	1	1	2	1	1
Dolžina tipala					
80 mm	5204-21	–	–	5207-21	–
160 mm	5204-27	5205-47	5206-47	5207-27	5207-47
250 mm	5204-26	5205-46	5206-46	5207-26	5207-46
400 mm	–	5205-48	5206-48	–	5207-48
Steblo tipala iz	med.	1.4571	1.4571	med.	1.4571
Imenski tlak	PN 16	PN 40	PN 40	PN 16	PN 40
Dopustna temperatura [°C]					
Medij	-20...150	-60...400	-60...400	-20...150	-60...400
Okolica	-20...70	-20...70	-20...70	-20...70	-20...70
Konstruktivna izvedba					
Tipski list	T 5203	T 5203	T 5203	T 5220	T 5220



Slika 6 · Uvojno tipalo tipa 5205/5206

Termostati

Tipsko preizkušeni termostati, namenjeni za uporabo kot nadzorniki temperature (TW), varnostni nadzorniki temperature (STW), temperaturni regulatorji (TR) ali varnostni omejevalniki temperature (STB), kakor tudi kot kombinacije temperaturnih regulatorjev in varnostnih omejevalnikov temperature (TR/STB) ali temperaturnih regulatorjev in varnostnih nadzornikov temperature (TR/STW).

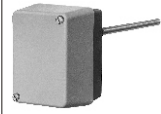
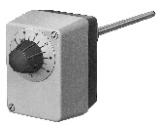
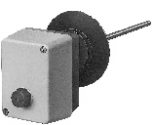
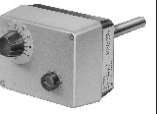
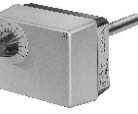

Tip	5312-2	5313-4 do -10	5314-1 do -3	5315-1 do -3	5317-2 do -5	5318-1 do -4
Funkcija	TW	STW	TR	STB	TR/STB	TR/STW
Območje zahtev. vrednosti [°C]	-10 ... 12	med 0 ... 60 in 50 ... 300	20 ... 90 ali 20 ... 150	med 30 ... 110 in 130... 200	med 30 ... 110 in 60 ... 130	med 0 ... 70 in 20 do 110
Dolžina tipala [mm]	6000	150, 200, 300	100, 150, 300	150	150	150, 300
Maks. temperatura medija [°C]	200	med 69 in 345	103 ali 172	med 126 in 230	med 103 in 149	80 ali 138
Maks. tlak [bar]	–	med 48 in 92	med 48 in 92	med 48 in 88	med 26 in 50	med 26 in 50
Konstruktivna izvedba						
Tipski list	T 5205					

Pridržujemo si pravico do tehničnih sprememb.



SAMSON AG MESS- UND REGELTECHNIK
Weismüllerstr. 3 D-60314 Frankfurt am Main
Tel.: +49 69 4009-0 Faks: +49 69 4009-1507
www.samson.de



GIA-S · Industrijska oprema d.o.o.
Industrijska 5 · SLO-1290 Grosuplje
Tel.: 01 7863 300 · Faks: 01 7863 568
gia@gia.si · www.giaflex.com

T 5200 SL