

Application

Control of max. two control circuits



The TROVIS 5573 Heating and District Heating Controller is used to control max. two control circuits:

- Control of a primary heat exchanger or boiler with max. one mixing and one non-mixing heating circuit (both weather-compensated) as well as control of DHW heating in the secondary circuit
- Weather-compensated buffer storage tank control with solid-fuel boiler or solar circuit control
- Control of one weather-compensated heating circuit and a DHW heating with two valves in the primary circuit
- Control of two weather-compensated heating circuits with two valves in the primary circuit

Versions

- **TROVIS 5573-000x:** Controller with icon readings on the display
- **TROVIS 5573-100x:** Controller with plain-text readings on the graphics display
- **TROVIS 5573-110x:** Controller with graphics display and M-bus interface for three M-bus units

Special features

- Rotary switches for direct access to the operating modes and essential parameters of the control circuits
- Intuitive data retrieval and input by pressing and turning the pushbutton
- 365-day clock with max. four time schedules and automatic summer time/winter time changeover; maximum three times-of-use per day (input in steps of 15 minutes)
- Room panels connected to individual heating circuits to override operating mode and rated room temperature
- Demand-driven control by set point demand by subsequent controllers over a 0 to 10 V signal: the primary circuit controls the maximum flow temperature demanded plus adjustable boost.
- Heating characteristics optionally based on the gradient or based on four points; variable return flow temperature limitation

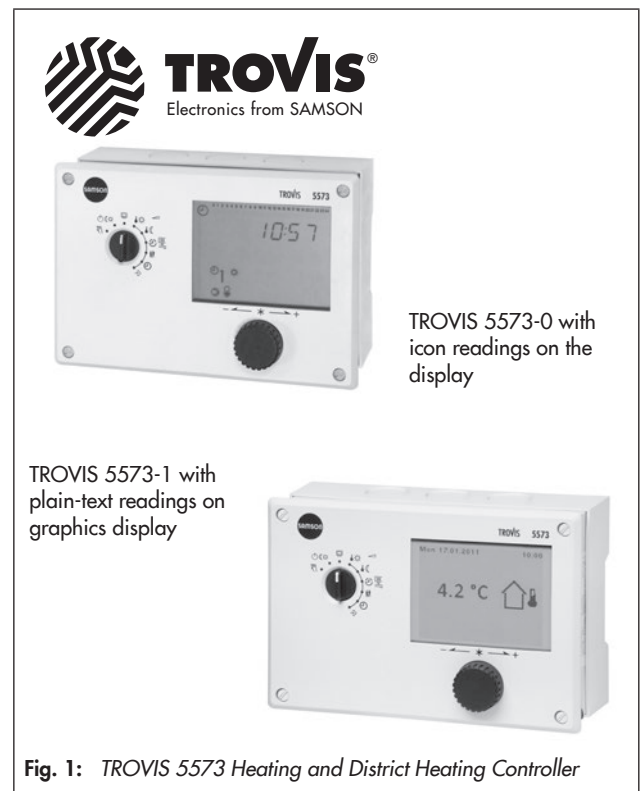



Fig. 1: TROVIS 5573 Heating and District Heating Controller

- Adaptation: automatic adaptation of the heating characteristic (room temperature sensor required)
- Optimization: calculation of the best possible activation and deactivation times for the heating (room temperature sensor required)
- Drying of jointless floors function with adjustable parameter settings
- Updatable flash memory in controller (operating system)
- Configuration and parameterization using a memory module
- Data logging function:
 - Operating data can be saved to a data logging module
 - Data can be displayed in the data log viewer on the PC
 - TROVIS 5573-1: analysis on the graphics display of the data saved in the operating data memory

Operation

The TROVIS 5573 Heating and District Heating Controller is adapted to the specific system by setting the appropriate system code number. To select the code number, refer to the system schematics described in the associated mounting and operating instructions. Additional sensors and/or functions which are not part of the system's basic configuration may be selected over function blocks.

Place the rotary switch to  and enter the key number to get to the different levels. For trained staff, the configuration levels used to set function blocks are indicated by "CO" and the parameter levels are indicated by "PA". For example, a clear distinction is made between two heating circuit levels and the domestic hot water level.

Data is retrieved and entered at the controller using a rotary pushbutton. Icons (TROVIS 5573-000x) or icons and plain-text readings (TROVIS 5573-100x) appear on the display. The rotary switch is used to set the operating mode and the parameters required for each circuit (Fig. 2).

M-bus interface (TROVIS 5573-110x only)

A maximum of three meters conforming to EN 1434-3 may be connected for data transfer. In addition, heat meter WMZ 1 for control circuit RK1 and heat meter WMZ 2 for control circuit RK2 for flow rate and/or capacity limitation can be used. Various limits can be adjusted for the different operating modes "Heating control only", "Heating control with DHW heating" and "DHW heating only" in control circuit RK1. Weather-compensated flow rate or capacity limitation can also be implemented.

Electrical connection and installation

The controller consists of the housing containing the electronics and a separate terminal board for electrical connection. Two wires of max. 1.5 mm² may be connected to each terminal. The sensor connection lines must be installed separately from the lines carrying the power supply. For wall mounting, screw the terminal board to the wall. After wiring the controller, place the controller housing onto the terminal board and fasten it with two screws. Two adjustable fixing clamps attached to the controller are used for panel mounting.

Ordering text

TROVIS 5573 Heating and District Heating Controller

- with icon readings on the display/
with plain-text readings on the graphics display/
with graphics display and M-bus interface
- with standard base/high housing base

Options

RS-232 to PC communications module	(8812-2003)
RS-232 to modem communications module	(8812-2004)
RS-485 communications module	(8812-2002)

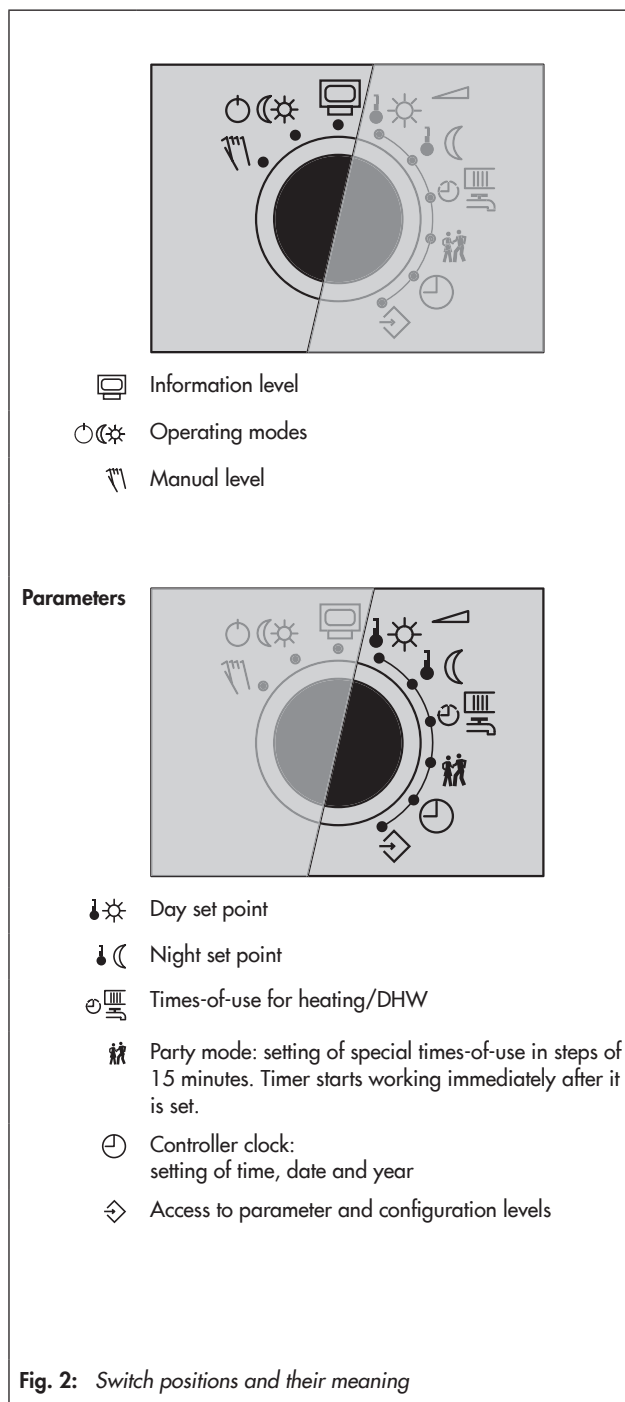

Fig. 2: Switch positions and their meaning

Accessories:

- Type 5257-5 Room Panel
- Memory module (1400-9379)
- Mini module (1400-7436)
- Data logging module (1400-9378)
- USB converter 3 together with data log viewer software (1400-9377)
- TROVIS-VIEW software

Technical data

Inputs	8 inputs for Pt 1000 temperature sensors and two binary inputs, input terminal 11 for 0 to 10 V signal for external demand by subsequent controllers or outdoor temperature signal
Outputs*	2 x three-step signal: load max. 250 V AC, 2 A, switch-on surge, max. 16 A Alternatively 2 x on/off signal: load max. 250 V AC, 2 A, switch-on surge, max. 16 A 3 x pump output: load max. 250 V AC, 2 A, switch-on surge, max. 16 A; all outputs are relay outputs with varistor suppression Input terminal 11 for 0 to 10 V output for continuous-action control for control circuit Rk1 or signal for external demand, load > 5 kΩ
Interfaces (TROVIS 5573-110x only)	M-bus for max. three M-bus units, protocol according to EN 1434-3
Operating voltage	85 to 250 V, 48 to 62 Hz, max. 1.5 VA
Ambient temperature	0 to 40 °C (operation), -10 °C to 60 °C (storage and transport)
Degree of protection	IP 40 according to IEC 60529
Class of protection	II according to VDE 0106
Degree of contamination	2 according to VDE 0110
Overvoltage category	II according to VDE 0110
Humidity rating	F according to VDE 40040
Noise immunity	According to EN 61000-6-1
Noise emission	According to EN 61000-6-3
Weight	Approx. 0.5 kg
Compliance	CE · EAC

* For systems with one control circuit, a maximum of four pumps are available

Dimensions in mm

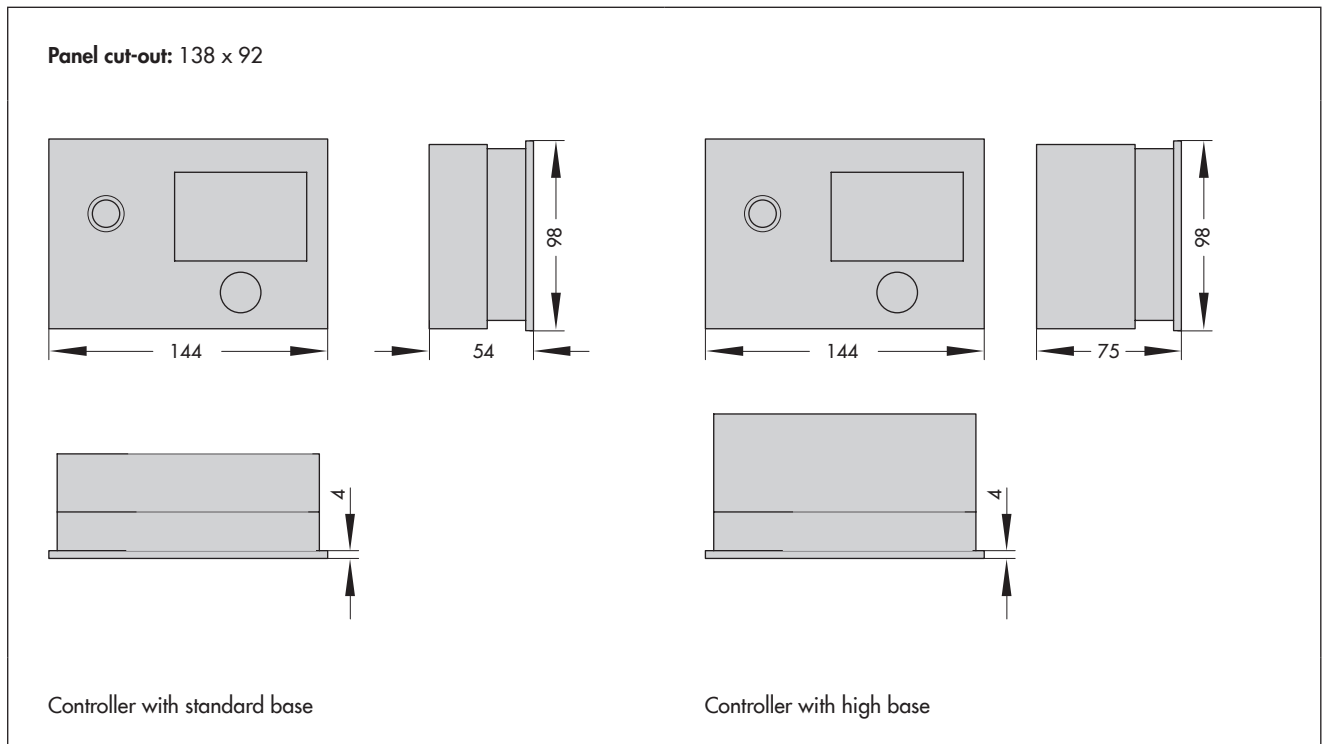

Terminal assignment

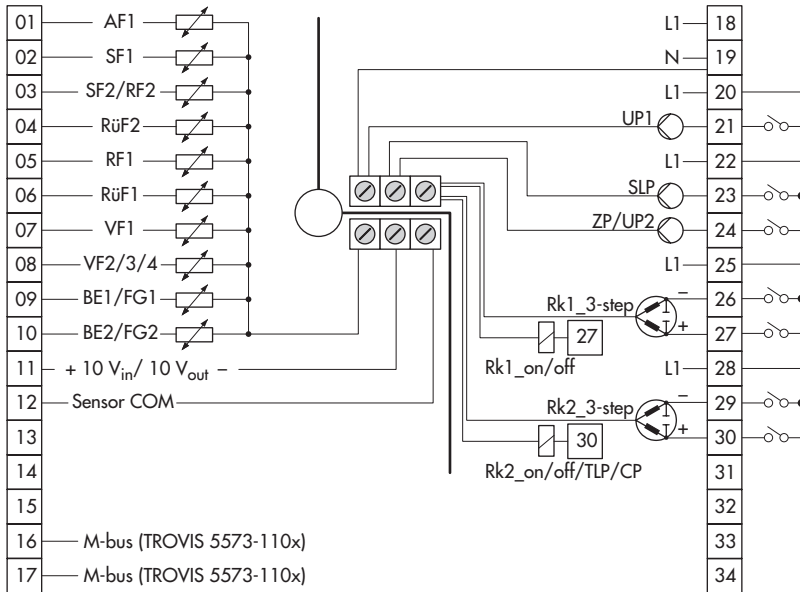

Fig. 3: Terminal assignment of TROVIS 5573 Controller with standard base

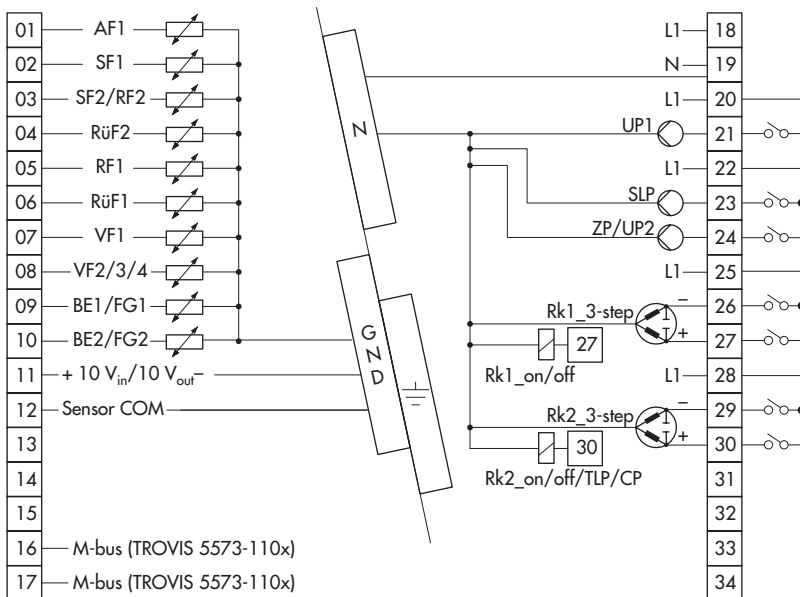

Fig. 4: Terminal assignment of TROVIS 5573 Controller with high base

AF	Outdoor sensor	CP	Solar circuit pump
BE	Binary input	Rk	Control circuit
FG	Potentiometer	UP	Circulation pump (heating)
RF	Room sensor	SLP	Storage tank charging pump
RüF	Return flow sensor	TLP	Heat exchanger charging pump
SF	Storage tank sensor	ZP	Circulation pump (DHW)
VF	Flow sensor		

Specifications subject to change without notice



SAMSON AG · MESS- UND REGELTECHNIK
 Weismüllerstraße 3 · 60314 Frankfurt am Main, Germany
 Phone: +49 69 4009-0 · Fax: +49 69 4009-1507
 samson@samson.de · www.samson.de

T 5573 EN

2016-02-11 · English