

Automation System TROVIS 6400

Industrial Controller TROVIS 6497



Designed for panel mounting
(dimensions of front frame: 96 x 96 mm/3.78 x 3.78 inch)

Application

Microprocessor-controlled industrial controller with flexible software design; used for automating industrial and process engineering plants.



The TROVIS 6497 Industrial Controllers can be used for almost any control task. They can be used not only for constructing simple control loops, but also for solving complex control tasks. A flexible software design allows the user to configure all common control circuit arrangements without having to modify the controller hardware. This is facilitated by means of function blocks, stored in memory, which can be adapted to the different settings of the plant-specific configuration.

Special features include:

- Display panel containing two digital LED displays (red) which, in "standard operation", display controlled variable (process value) **X** and output variable **Y**
- Front-panel operation and configuration via six keys only
- Universal input options: Pt 100 resistance thermometers, potentiometers, four different thermocouples or standardized 4(0) to 20 mA 0(2) to 10 V signals
- Connection for two-wire transmitters
- Bumpless transfer (MANUAL/AUTOMATIC mode) guaranteed in both directions
- Data and parameters protected against power failure in non-volatile memory (EEPROM)
- Fully sealed membrane keyboard; degree of protection IP 54 on the front side
- Selection between units of temperature, either °C and °F
- Self-tuning feature
- User-selectable controller output:
Continuous analog, on-off (two-point) and three-step

Versions

These TROVIS 6497 Industrial Controllers are delivered in panel-mounting cases according to DIN 43 700 (dimensions of the front frame: 96 x 96 mm). They can optionally be equipped with an RS-485 serial interface and Modbus RTU software.

TROVIS

6497-03

Continuous/on-off/three-step, analog output,
limit switches

Options

Two additional limit switches
RS-485 serial interface with Modbus RTU software



Fig. 1 · TROVIS 6497 Industrial Controller

Design features

TROVIS 6497 accepts the following universal inputs:

- Three-wire Pt 100 resistance thermometer available in two hardware versions:
 - 100 °C to +400 °C (-150 °C to +750 °F) in 1° steps or
 - 30 °C to +150.0 °C (-22 °C to +300 °F) in 0.1° steps
- Standardized 4(0) to 20 mA current signal
- Standardized 0(2) to 10 V voltage signal
- Four thermocouples with stored linearization tables:
 - NiCr-Ni; (K)DIN IEC 584; 50°C to +1200°C (122°F to +2190°F)
 - Pt 10 Rh-Pt; (S)DIN IEC 584; 50°C to +1700°C (122°F to +3090°F)
 - Fe-CuNi; (L)DIN 43710; 50°C to +800°C (122°F to +1470°F)
 - Cu-CuNi;(U)DIN 43710 50°C to +600°C (122°F to +1110°F)

The various input options can be selected via front-panel keys. Therefore, no hardware configuration (various input cards) is necessary, allowing subsequent modification of the input signal when required.

The TROVIS 6497 Industrial Controller has the advantage that both a continuous and an on-off/three-step controller output (or also pulse-modulated controller outputs) can be configured (Figs. 2 and 3).

In addition, limit switches GW3 and GW4 can optionally be added as extensions to TROVIS 6497.

The industrial controller can be switched to the MANUAL mode with the MANUAL/AUTOMATIC selector switch. In this mode, it can be operated as an "open-loop" controller. The controller output signal is then modified via the cursor keys.

An internal power supply (3) provides +24 V/max. 30 mA (Fig. 4) for connecting a two-wire transmitter (1). The industrial controller (2) accepts a load-independent current signal from 4 to 20 mA. There is also an internal connection (4) between the negative (-) poles.

An external setpoint*, WE, can be connected either by actuating the WE/WI changeover key (9 in Fig. 5), or by supplying an external signal at terminals 12 and 5 (connection diagram).

*Reference variable

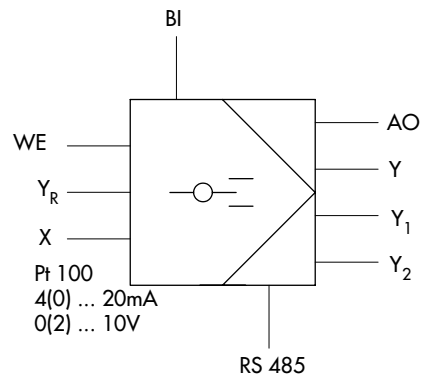

Fig. 2 · TROVIS 6497 with switching output

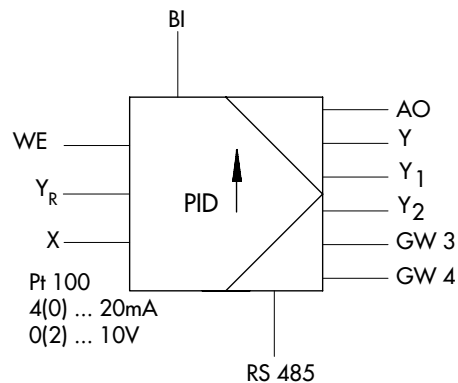
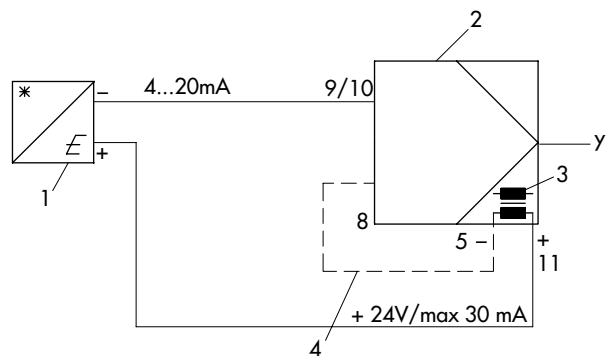

Fig. 3 · TROVIS 6497 with continuous output



- 1 Transmitter
- 2 Industrial controller
- 3 Internal power supply
- 4 Internal negative (-) pole connection (via terminals 5 and 8)

Fig. 4 · Circuit diagram of a TROVIS 6497 Industrial Controller with a two-wire transmitter

Operation

TROVIS 6497 uses a three-level operating structure:

- Operating level
- Parameterization level
- Configuration level

Parameter and configuration levels are protected against unintentional or unauthorized access by means of user-definable code numbers.

Operating level

This is the "standard operating level" of the controller. The actual value of controlled variable **X** is displayed in the LED display (1), and the output variable **Y** is displayed in the digital LED display (2). All other controlled variables are selected by pressing the operating key (7).

Parameter level

A code number must be entered in order to access the parameter level. Numeric values of the parameters are determined using the cursor keys (6). The associated values can be viewed in the first digital LED display (1). Parameter designations such as proportional-action coefficient, **KP**, reset time, **TN**, etc. appear in the second digital LED display (2).

Configuration level

This level is also protected by means of a code number. The cursor keys can be used to select any sequence of configuration blocks, these of which can be viewed in the second digital LED display (2). The associated configuration modes are displayed in the first digital LED display (1).

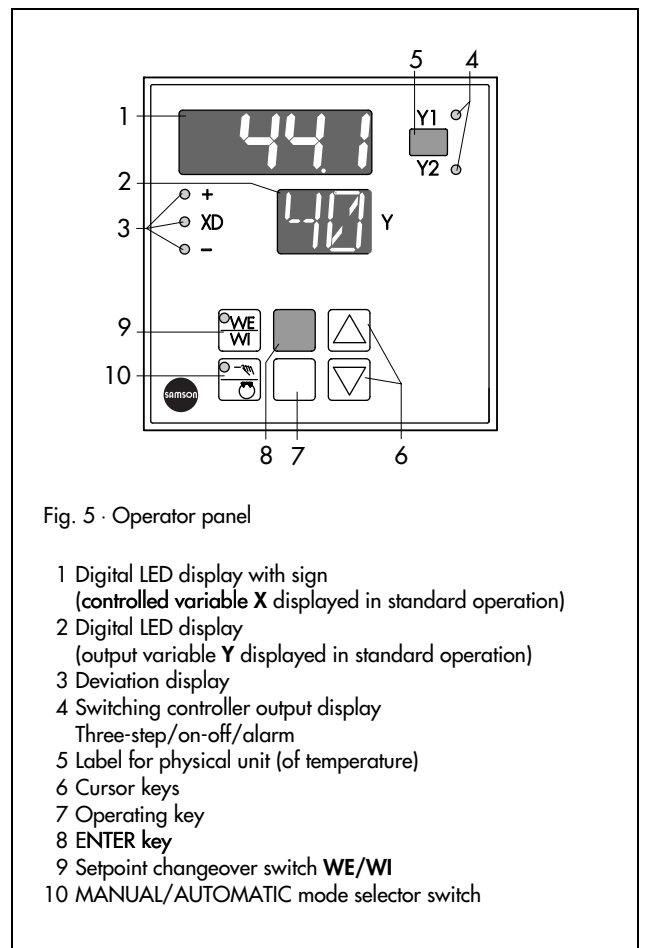

Fig. 5 · Operator panel

- 1 Digital LED display with sign (controlled variable **X** displayed in standard operation)
- 2 Digital LED display (output variable **Y** displayed in standard operation)
- 3 Deviation display
- 4 Switching controller output display
Three-step/on-off/alarm
- 5 Label for physical unit (of temperature)
- 6 Cursor keys
- 7 Operating key
- 8 ENTER key
- 9 Setpoint changeover switch **WE/WI**
- 10 MANUAL/AUTOMATIC mode selector switch

Installation and electrical connection

Panel-mounting version with two mounting elements for securing in a control panel.

Electrical connection: Modular terminal blocks for signal wires 0.5 to 1.5 mm² (terminal markings according to DIN 45 140).

Ordering text

Industrial Controller TROVIS 6497-03

Universal input for Pt 100: -100°C to +400°C (-150°F to +750°F) or -30°C to +150°C (-22°F to +300°F)

Power supply: 230 V AC/ 115 V AC/ 24 V AC

With/without RS-485 serial interface w. Modbus RTU software

Reference junction for thermocouple, order no. 1600-1269

Option: Two additional limit switches

Technical data

Universal inputs	
Analog inputs	Controlled variable X : 4(0) to 20 mA, 0(2) to 10 V, Pt 100 or thermocouple External feedback YR : Potentiometer (self-adjusting) 0...(200 to 1000) Ω or 4(0) to 20 mA External setpoint WE : 4(0) to 20 mA or 0(2) to 10 V
Binary input	Changeover between internal and external setpoints WI/WE
Transmitter supply	+24 V, maximum 30 mA
Standard controller outputs	
Continuous output	-20, 4(0) to 20 mA; -10, 0(2) to 10 V; on-off or three-step control signal
Switching output	Two switching controller outputs, maximum load 250 V AC, 1 A
Analog output	0(4) to 20 mA, 0(2) to 10 V
Options	Two additional limit switches
Displays	Digital LED display with 3½-digit numeric display with sign 2-digit alphanumeric digital display, optionally output variables (%) or variable display Lighted displays for switching controller outputs and limit value messages (alarms), sign of deviation
Configuration	Function blocks stored in memory for fixed setpoint and follow-up control Changeover between internal/external setpoints WE/WI
Power supply	230 V AC/ 115 V AC/ 24 V AC (optional), 48 to 62 Hz
Ambient temperature	0 to 50°C (32 to 120°F)
Degree of protection	IP 54 (front side); IP 20 (terminals)
Weight	0.8 kg (1.8lb)

Dimensions in mm (inch)

Panel-mounting version (dimensions of front frame: 96 x 96 (3.78 x 3.78))
 Panel cut-out $92^{+0.8} \times 92^{+0.8}$ ($3.62^{+0.3} \times 3.62^{+0.3}$)

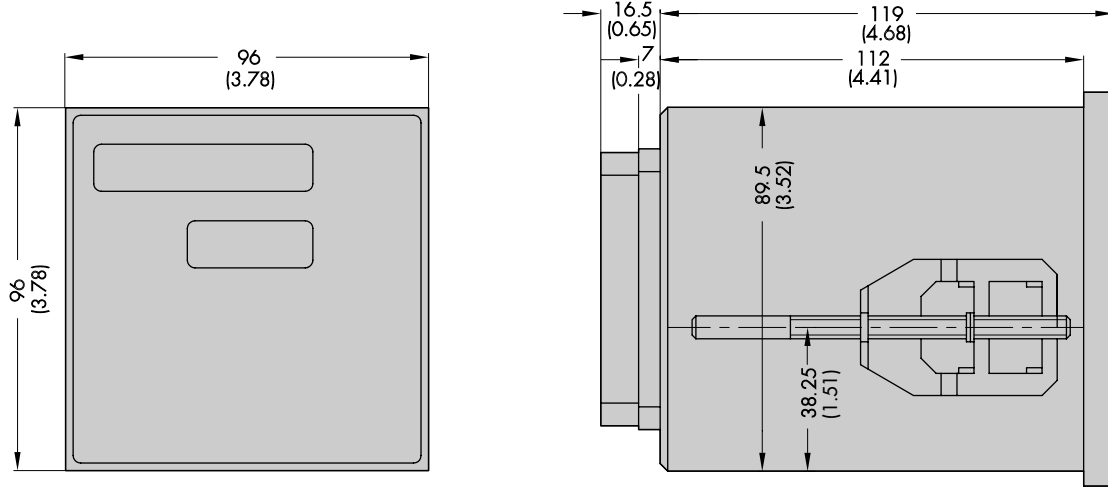

Controller input (controlled variable X)

4(0) to 20 mA

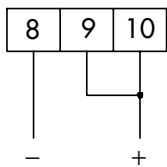

0(2) to 10 V

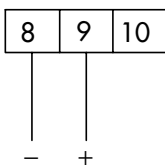

Pt 100

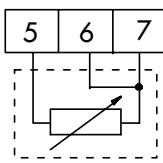

Thermocouple

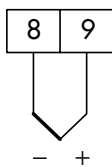

Reference junction required

2-wire transmitter
X input 4 to 20 mA

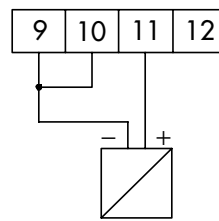

External setpoint WE

4(0) to 20 mA

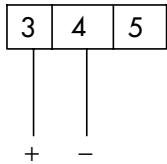

0(2) to 10 V

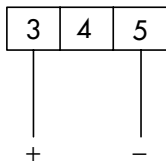

Changeover 24 V-
WE/WI

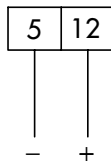

External position
feedback

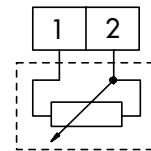

Controller output (output variable Y)

4(0) to 20 mA

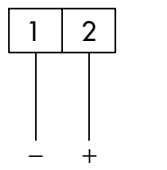

0(2) to 10 V

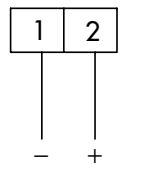

Three-step outputs
at load > 50 VA, contactors
or relays are to be provided

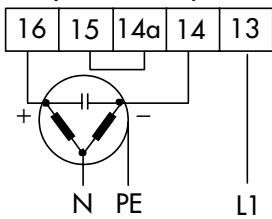

2 limit switches

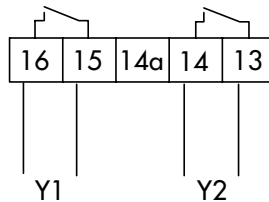

Option: 2 limit switches

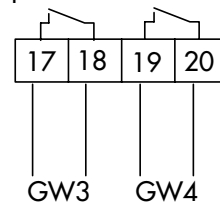

UV

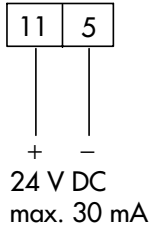

Power supply

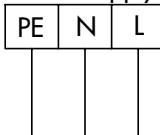

Analog output X

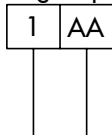

Option: Serial interface

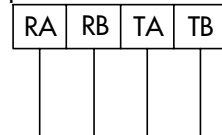

24 V DC
max. 30 mA

120, 230, 24 V AC

V or mA with jumper AA

Receive Transmit



SAMSON CONTROLS INC.
 1 - 105 Riviera Drive
 Markham · Ontario · Canada · L3R 5J7
 Tel. (905) 474-0354 · Telefax (905) 474-0998
 Internet: <http://www.samsoncontrols.com>

SAMSON CONTROLS INC.
 4111 Cedar Boulevard
 Baytown · Texas · USA · 77520-8588
 Tel. (281) 383-3677 · Telefax (281) 383-3690
 Internet: <http://www.samson-usa.com>

T 6497

T 6497 CA