

Application

On/off valve with pneumatic piston actuator

Nominal size DN 15 to 50 (NPS ½ to 2)

Nominal pressure PN 40

Temperature range -10 to 180 °C



Globe valve with an angle seat body and a soft-seated flat plug with:

- Pneumatic piston actuator
- Stainless steel body

Permissible media:

- Water
- Air
- Neutral gases and liquids
- Oils
- Steam up to 180 °C
- Corrosive media

Easy serviceability and low price due to:

- Replaceable soft seal
- Safe relief of the actuator springs without having to use a spring clamping device

Version

Angle seat valve in nominal sizes DN 15 to 50 (NPS ½ to 2), body made of stainless steel 1.4408, nominal pressure PN 40

Pneumatic piston actuator with either 30 or 60 cm² effective area (63 or 90 mm piston diameter)

Type 3353 · Angle seat valve, end connections with female thread (Fig. 1) or with welding ends according to ISO 4200, DIN 11850 Series 2 or ISO 2037

Accessories

- Type 4740 Limit Switch with inductive proximity switches or with microswitches, optionally with 3/2-way solenoid valve (max. 7 bar, Fig. 2)
- Fixture for holding proximity switches with M12 thread
- Limit switch with inductive proximity switches for spring-to-close or spring-to-open version
- NAMUR adapter to attach a solenoid valve
- 3/2-way solenoid valve with G ⅛ for direct attachment to the actuator (double nipple required for mounting) in DN 15 (NPS ½), 0 to 12 bar, 24 V DC or 230 V AC, optional silencer
- Double nipple G ⅛ x G ¼ detachable, brass



Fig. 1: Type 3353 Angle Seat Valve with pneumatic actuator
End connections with female thread



Fig. 2: Type 4740 Limit Switch with optional solenoid valve on a
Type 3353 Angle Seat Valve

Principle of operation

The process medium flows through the valve in the direction indicated by the arrow in the flow-to-open direction. The valve plug position determines the cross-sectional area between the seat and plug.

Fail-safe position

Depending on how the springs are arranged in the pneumatic actuator (Fig. 4 and Fig. 5), the valve has two fail-safe positions effective upon air supply failure.

Fail-close (FA/NC):

The valve is closed upon air supply failure.

Fail-open (FE/NO):

The valve is opened upon air supply failure.

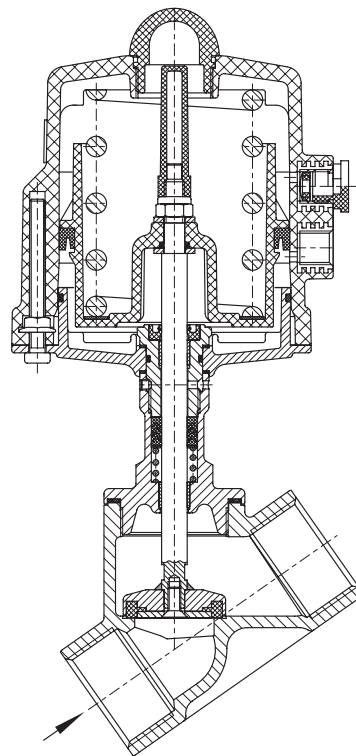

Fig. 4: Type 3353 Angle Seat Valve Actuator with fail-safe action: fail-close

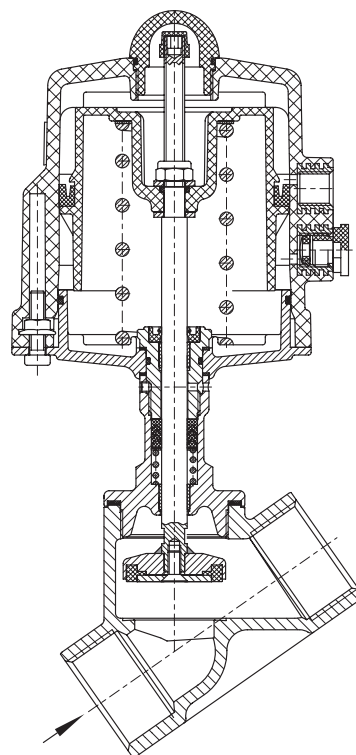

Fig. 5: Type 3353 Angle Seat Valve Actuator with fail-safe action: fail-open

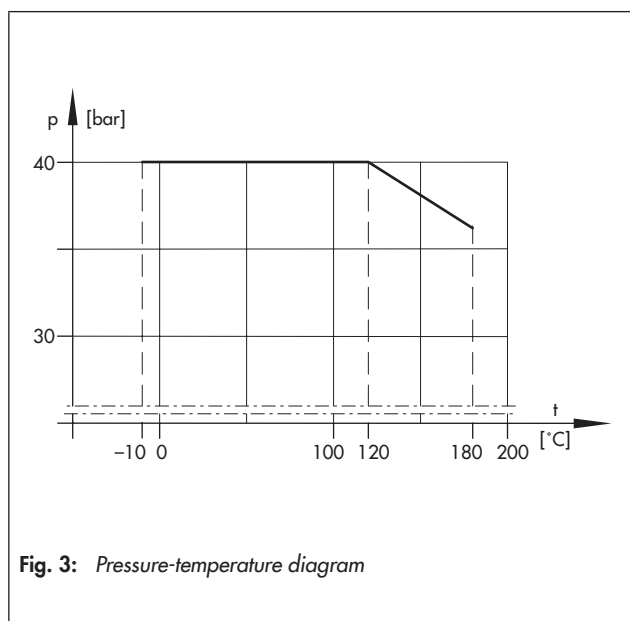

Fig. 3: Pressure-temperature diagram

Table 1: Technical data for Type 3353 Angle Seat Valve

Nominal sizes	DN 15 to 50 · NPS ½ to 2
Material	1.4408
Type of end connections	Welding ends · Female thread
Nominal pressure	PN 40
Seat/plug seal	Soft seal
Characteristic	Quick opening
Actuator	30 cm ² (Ø = 63 mm) or 60 cm ² (Ø = 90 mm)
Permissible signal pressure	Minimum as listed in Table 4.1 and Table 4.2 · Maximum 8 bar
Signal pressure connection	G ¼
Temperature range	
Perm. medium temperature	-10 to 180 °C
Perm. ambient temperature	-10 to 60 °C
Permissible flow velocity	
Max. velocity at the valve outlet	Liquids: 3 m/s · Gases: 0.3 Mach

Table 2: Materials

Valve body	Cast stainless steel · 1.4408
Connecting piece	1.4408
Actuator stem	1.4404
Flat plug	1.4404
Seal	PTFE, glass fiber reinforced
Packing	PTFE/carbon, spring-loaded
Actuator	
Cover	PA 66, glass fiber reinforced
Piston	PA 66, glass fiber reinforced
Base	1.4408

Table 3: Overview: Nominal sizes, valve coefficients and seat diameters

Nominal size	DN (NPS)	15 (½)	20 (¾)	25 (1)	32 (1¼)	40 (1½)	50 (2)
Flow coefficient	K _{VS}	5	9	17	23	40	52
Seat Ø	mm	20		31		48	
Travel	mm	15					

Table 4: Permissible differential pressures for Type 3353 Angle Seat Valve

Specifications for the standard version have a gray background.

Table 4.1: Version FA/NC with fail-safe position: fail-close

Valve size		DN	15 · 20	25 · 32	40 · 50
		NPS	½ · ¾	1 · 1¼	1½ · 2
Actuator	Signal pressure in bar	Δp			
Actuator area					
30 cm ²	5.0	20	10	4	
60 cm ²	3.8	40	16	6	
	5.4	–	25	10	

Table 4.2: Version FE/NO with fail-safe position: fail-open · Allocation according to nominal size and actuator size

Required actuators and signal pressures to close the valve at the specified differential pressure.

Nominal size	DN (NPS)	15 (½) · 20 (¾)
Actuator effective area	Signal pressure in bar	Δp
30 cm ² ($\varnothing = 63$ mm)	4	6
	5	16
	6	26
	7	36
	8	40
60 cm ² ($\varnothing = 90$ mm)	3	27
	4	40

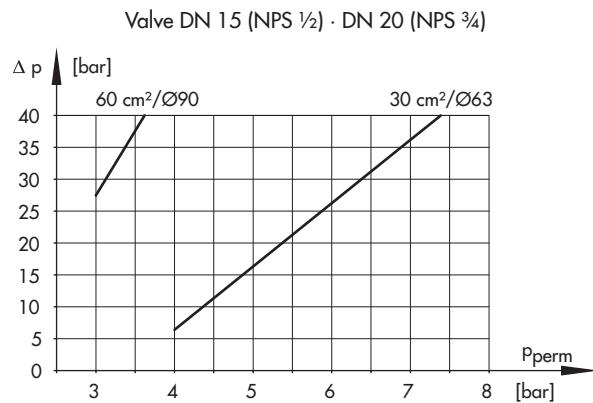

Nominal size	DN (NPS)	25 (1) · 32 (1¼)
Actuator effective area	Signal pressure in bar	Δp
30 cm ² ($\varnothing = 63$ mm)	5	6
	6	10
	7	14
	8	18
60 cm ² ($\varnothing = 90$ mm)	3	11
	4	19
	7	40

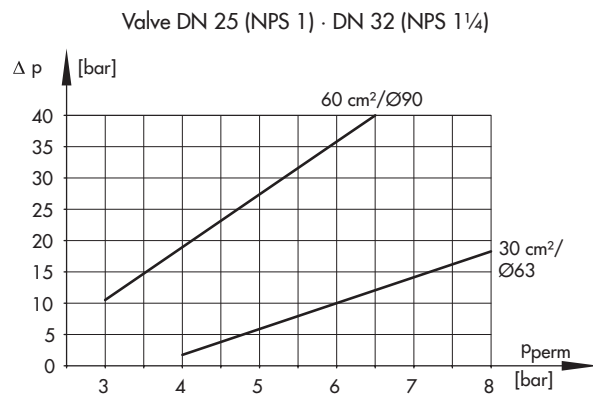

Nominal size	DN (NPS)	40 (1½) · 50 (2)
Actuator effective area	Signal pressure in bar	Δp
30 cm ² ($\varnothing = 63$ mm)	5	2
	6	4
	7	5
	8	7
60 cm ² ($\varnothing = 90$ mm)	3	4
	4	7
	5	11
	6	14
	7	18
	8	21

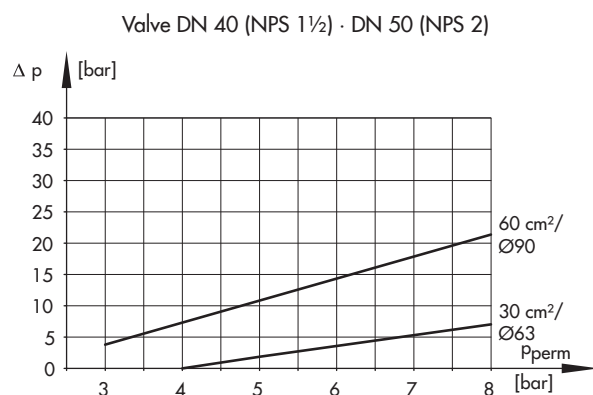

Table 5: Dimensions in mm and weights in kg**Table 5.1:** Version with female thread

Nominal size	DN (NPS)	15 (½)	20 (¾)	25 (1)	32 (1¼)	40 (1½)	50 (2)
Face-to-face dimension L	mm	65	75	90	110	120	150
End-to-end length L1	mm	170	175	197	205	210	226
Height including actuator H	mm	193	194	211	212	224	226
Body connection	G	G ½	G ¾	G 1	G 1¼	G 1½	G 2
Thread length t	mm	15	16	19	22	22	26
Valve weight	kg	0.28	0.33	0.64	0.8	1.3	1.9

Table 5.2: Version with welding ends according to ISO 4200, DIN 11850 Series 2 and ISO 2037

Nominal size	DN (NPS)	15 (½)	20 (¾)	25 (1)	32 (1¼)	40 (1½)	50 (2)
Face-to-face dimension L	mm	100	120	150	160	180	190
End-to-end length L1	mm	187	197	227	218	230	241
Height H including actuator	mm	197	199	214	223	230	229
Welding ends according to ISO 4200							
Ø-d1 connection	mm	18.1	23.7	29.7	38.4	44.3	55.1
Wall thickness s	mm	1.6		2		2.6	
Welding ends according to DIN 11850 Series 2							
Ø-d1 connection	mm	16	20	26	32	38	50
Wall thickness s	mm	1.5		1.5		1.5	
Welding ends according to ISO 2037							
Ø-d1 connection	mm	15.2	19.3	22.6	31.3	35.6	48.6
Wall thickness s	mm	1		1.2		1.2	
Valve weight	kg	0.28	0.33	0.64	0.8	1.3	1.9

Table 5.3: Pneumatic piston actuator

Version	Effective area/ piston Ø	30 cm ² /Ø 63 mm		60 cm ² /Ø 90 mm	
				One spring	Two springs
Housing ØD	mm	100		127	
Signal pressure connection		G ¼			
Weight	kg	1.35		2.2	2.75

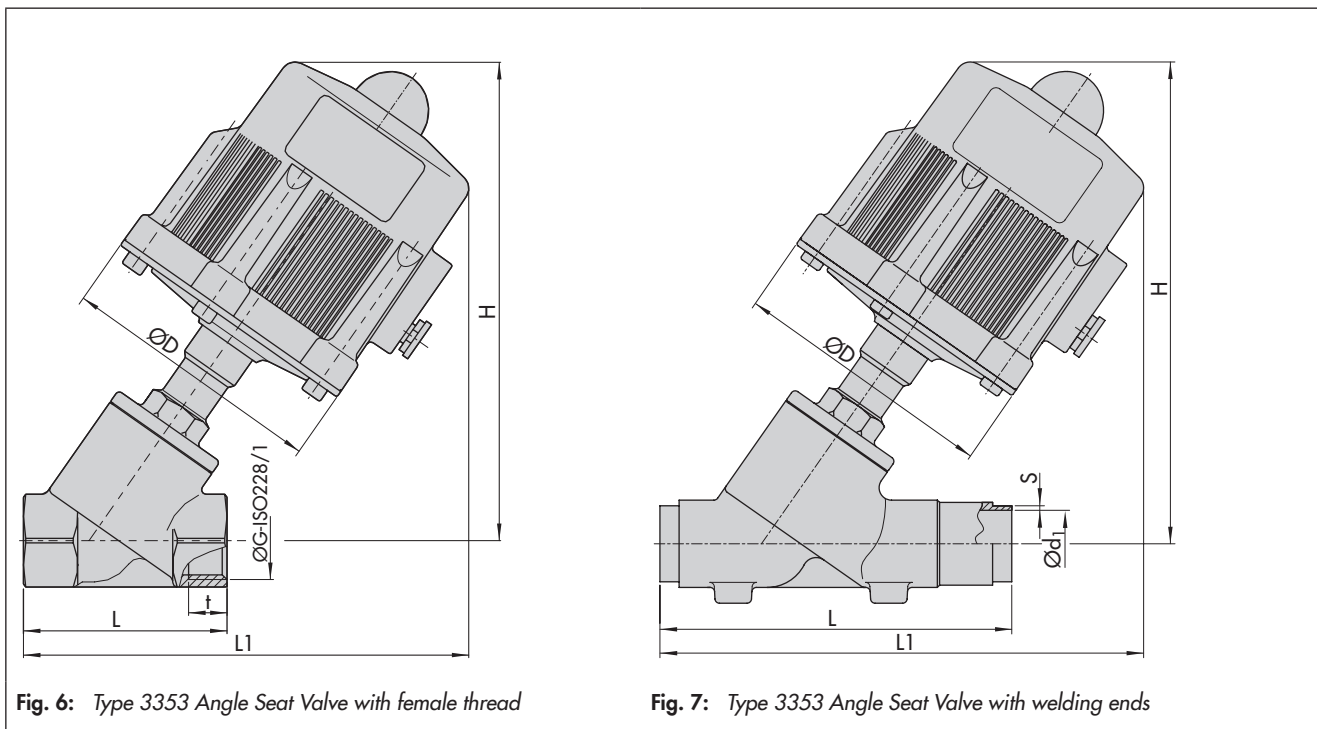

Fig. 6: Type 3353 Angle Seat Valve with female thread

Fig. 7: Type 3353 Angle Seat Valve with welding ends

Ordering text

The following specifications are required on ordering:

Operational data (for sizing performed by SAMSON)

Medium	<input type="checkbox"/> water <input type="checkbox"/> steam <input type="checkbox"/> neutral gas, e.g. air, nitrogen <input type="checkbox"/> ...
Flow rate	max. ...
Inlet pressure p_1	... bar
Outlet pressure p_2	... bar or
Differential pressure Δp	... bar
Temperature T_1	... °C

Type 3353 Angle Seat Valve

Nominal size	DN/NPS ...
Valve coefficient	K_{VS} ...
End connections	<input type="checkbox"/> female thread <input type="checkbox"/> welding ends acc. to ISO 4200 <input type="checkbox"/> welding ends acc. to DIN 11850 <input type="checkbox"/> welding ends acc. to ISO 2037

Pneumatic actuator

Effective area/piston \varnothing	<input type="checkbox"/> 30 cm ² /Ø 63 mm <input type="checkbox"/> 60 cm ² /Ø 90 mm, one spring <input type="checkbox"/> 60 cm ² /Ø 90 mm, two springs
Fail-safe position	<input type="checkbox"/> fail-close (FA) <input type="checkbox"/> fail-open (FE)

Additional equipment

Limit switch	<input type="checkbox"/> electric, fail-close <input type="checkbox"/> electric, fail-open <input type="checkbox"/> inductive, fail-close <input type="checkbox"/> inductive, fail-open
Fixture for holding proximity switches	<input type="checkbox"/>
NAMUR adapter	<input type="checkbox"/>
3/2-way solenoid valve and double nipple	<input type="checkbox"/> 24 V DC <input type="checkbox"/> 230 V AC
Silencer and fitting for solenoid valve	<input type="checkbox"/>

Specifications subject to change without notice

