

# Supply Pressure Regulator and Air Pressure Reducing Station Type 708



## Application

Versatile and combinable supply pressure regulators and air pressure reducing stations for supplying pneumatic measuring and control equipment with a constant air pressure, adjustable between 0 and 6 bar / 0 and 90 psi.

The supply pressure regulator controls and reduces an air system pressure of maximum 12 bar (180 psi) to the pressure adjusted at the set point adjuster.

Supply pressure regulators with mounting blocks can be directly attached to various pneumatic and electropneumatic transfer elements. The combinations possible are described in detail. Additionally, the supply pressure regulator can be combined with a manual/auto selector switch. Thus, it is possible to shut off the positioner output signal (Type 4763, Type 4765) and manually operate the control valve via the supply pressure regulator.

The air pressure reducing station consists of a supply pressure regulator and an upstream filter with condensate drain.

## Special features

- Air blow off and low air consumption
- Operation practically independent of the upstream pressure
- Any mounting position possible
- Suitable for mounting to panels or walls, and attachment to various pneumatic and electropneumatic transfer elements
- Option of equipping pressure gauge
- Optionally available with either lateral or rear threaded connections G acc. to DIN ISO 228/1, or tapered NPT pipe thread

## Versions

The output pressure of the supply pressure regulator (Fig. 1) can be continuously adjusted from 0 to 1.6 bar (0 to 23 psi) or from 0.5 to 6 bar (7 to 90 psi). Adjustment of the output pressure by means of a screw or a rotary knob. Pressure gauge for indicating the output pressure (Fig. 2) and angle bracket (accessory) available on request.

Supply pressure regulator	Type 708-	<input type="checkbox"/>	<input type="checkbox"/>	<input type="checkbox"/>	<input type="checkbox"/>
With rear air connection G 1/8		0	0	1	
With rear air connection NPT 1/8		0	0	4	
With lateral air connection G 1/4		1	0	2	
With lateral air connection NPT 1/4		1	0	5	
<b>Adjusting range: 0.5 to 6 bar (7 to 90 psi)</b>					
Without pressure gauge					0
With copper-free pressure gauge, compl. stainless steel					1
With pressure gauge, stainless steel casing, nickel-plated air connection					2
<b>Adjusting range: 0 to 1.6 bar (0 to 23 psi)</b>					
Without pressure gauge					3
With copper-free pressure gauge, compl. stainless steel					4
With pressure gauge, stainless steel casing, nickel-plated air connection					5

The **air pressure reducing station** (Fig. 3) consists of a supply pressure regulator with continuously adjustable output pressure between 0 and 1.6 bar (0 and 23 psi) or 0.5 bar and 6 bar (7 and 90 psi), and an air filter (20 µm) for removing dust and moisture. This filter is available with a choice of plastic or aluminum housings, including drain plug. Adjustment of the output pressure by means of a screw or a rotary knob. Pressure gauge for indicating the output pressure, rotary knob and angle bracket (accessory) available on request.

Air pressure reducing station with filter	Type 708-	<input type="checkbox"/>	<input type="checkbox"/>	<input type="checkbox"/>	<input type="checkbox"/>
With lateral air connection G 1/4, plastic filter housing		1	1	2	
With lateral air connection NPT 1/4, plastic filter housing		1	1	5	
With lateral air connection G 1/4, aluminum filter housing		1	2	2	
With lateral air connection NPT 1/4, aluminum filter housing		1	2	5	
<b>Adjusting range 0.5 to 6 bar (7 to 90 psi)</b>					
Without pressure gauge					0
With copper-free pressure gauge, compl. stainless steel					1
With pressure gauge, stainless steel casing, nickel-plated air connection					2
<b>Adjusting range 0 to 1.6 bar (0 to 23 psi)</b>					
Without pressure gauge					3
With copper-free pressure gauge, compl. stainless steel					4
With pressure gauge, stainless steel casing, nickel-plated air connection					5

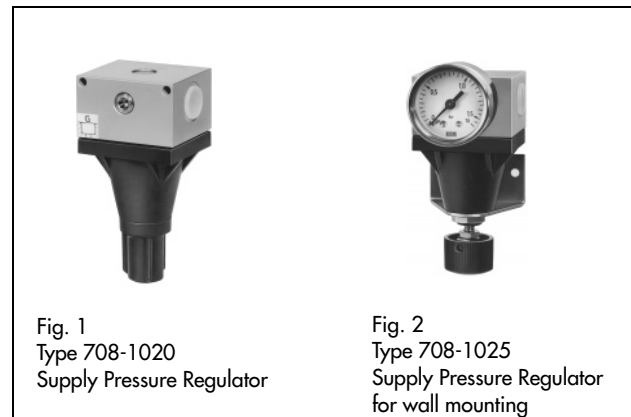

Fig. 1  
Type 708-1020  
Supply Pressure Regulator

Fig. 2  
Type 708-1025  
Supply Pressure Regulator  
for wall mounting



Fig. 3 · Type 708-112 Air Pressure Reducing Station with pressure gauge



Fig. 4 · Type 708-5322 Supply Pressure Regulator and Type 708-8220 Manual/Auto Selector Switch attached to Type 3767 Positioner



Fig. 5 · Type 708-5422 Supply Pressure Regulator attached to Type 3701 Solenoid Valve and Type 4763 Positioner



Fig. 6 · Type 708-5522 Adapter Block, attached to Type 4763 Positioner

**Versions of supply pressure regulators combined with pneumatic and electropneumatic transfer elements**

To attach or install the supply pressure regulator to/in the following transfer elements, the aluminum casing of the supply pressure regulator is designed such that it can be used as mounting block. Special screws and nuts are used to create a simple mechanical air connection between them. The pressure gauges have a stainless steel casing and a nickel-plated air connection G 1/8.

**Note:** For connection to operating systems with air containing dust, oil and condensate, SAMSOMATIC service units are suited to treat the compressed air.

**Supply pressure regulator for installation in Type 3432 Pneumatic Controller Station** Type 708-5003

(Please refer to Data Sheet T 7030 EN for details)  
 Input: Operating pressure from 2 to 12 bar (30 to 180 psi)  
 Output: Supply air adjusted to 1.4 bar (20 psi)

**Mounting block with supply pressure regulator for attachment to Type 3771 Pneumatic Positioner** Type 708-5   2

Version with 3 pressure gauges for input signal, scale 0 to 1.6 bar (0 to 23 psi), air pressure and supply air, scale 0 to 6 bar (0 to 90 psi), with lateral air connection G 1/4 NPT 1/4

1 2  
1 5

**For attachment to Type 3772 Electropneumatic Positioner**

Version with 2 pressure gauges for air pressure and supply air, scale 0 to 6 bar (0 to 90 psi), with lateral air connection G 1/4 NPT 1/4

2 2  
2 5

**For attachment to Type 3766/3767 Electropneumatic Positioner**

Version with 2 pressure gauges for air pressure and supply air, scale 0 to 6 bar (0 to 90 psi), with lateral air connection G 1/4 NPT 1/4

3 2  
3 5

**For attachment to Type 3701 Solenoid Valve (Fig. 5)**

For solenoid valves with rear air connections (s. Data Sheet T 8375 EN), the supply pressure regulator must be used as adapter block for connection to Type 4763/4765 Positioners; Version with 1 pressure gauge for supply air, scale 0 to 6 bar (0 to 90 psi), with lateral air connection G 1/4 NPT 1/4

4 2  
4 5

**For attachment to Type 4765/4763 Pneumatic/Electropneumatic Positioner (Fig. 6)**

Version with 1 pressure gauge for supply air, scale 0 to 6 bar (0 to 90 psi), w. lateral air connection G 1/4 NPT 1/4

5 2  
5 5

**For attachment to Type 3760 Pneumatic/Electropneumatic Positioner**

Version with 1 pressure gauge for supply air, scale 0 to 6 bar (0 to 90 psi), w. lateral air connection G 1/8 NPT 1/8

7 1  
7 4

**Adapter block (without supply press. reg.)** Type 708-81  2

For connecting a Type 3701 Solenoid Valve with rear air connections (see Data Sheet T 8375 EN) to a Type 4763/4765 Positioner with lateral air connection G 1/4 NPT 1/4

2 5

**Manual/auto selector switch** Type 708-82  0

For attachment to Type 708-53.2 or Type 708-63.2 Supply Pressure Regulator combined with Type 3766/3767 Positioners, with lateral air connection G 1/4 NPT 1/4

2 5

**Manual/auto selector switch** Type 708-8  0

For attachment to Type 708-55.2 Supply Pressure Regulator combined with Type 4765/4763 Positioners, with lateral air connection G 1/4 NPT 1/4

5 2  
5 5

## Principle of operation

### Supply pressure regulator (Fig. 7)

The operating air available at the input flows across the open space between seat (1.1) and plug (3). The output pressure  $p_A$  is conducted to the diaphragm (4) via a borehole. It creates a force that is compensated by the spring (6). When increasing the spring force by turning the spindle (7), the diaphragm plate (5) and plug (3) move upwards. The open space between seat (1.1) and plug (3) increases, resulting in a higher output pressure.

If the output pressure is too high or the set point is decreased by relieving the spring (6), the diaphragm plate (5) is lifted off the plug (3). The excess pressure escapes through the diaphragm plate bore hole to the atmosphere until the balance is restored.

### Air pressure reducing station (Fig. 8)

The air pressure reducing station consists of a supply pressure regulator (2) and an upstream pressure filter (1). The compressed air coming in flows through a filter element (3) with a mesh size of 20  $\mu\text{m}$ . If condensate is in the air, it is filtered out as the air flows across a serrated lock washer (4) that forces the air into centrifugal motion and causes the condensate to splash against the walls of the filter housing (5). There it is collected at the bottom. The aluminum drain plug (6) is used to drain the condensate.

The filter housing (5) is optionally available as transparent plastic (polycarbonate) housing or aluminum housing.

### Supply pressure regulator with mounting block (Fig. 9)

To be able to combine the supply pressure regulator with various pneumatic and electropneumatic transfer elements, the aluminum housing (1) is designed such that it can be used as mounting block, thus allowing a simple, mechanical air connection. The special nuts (2) must be screwed into the corresponding tapped holes of the transfer element that is to be connected to the supply pressure regulator. Then, the mounting block is secured to the transfer element using special screws M8 (3) that also serve as air pipe. A gasket (4) seals this connection. The screw plug (5) is used to tightly seal the entire air duct. The mounting blocks have an integrated filter element with a mesh size of 20  $\mu\text{m}$ .

### Manual/auto selector switch (Figs. 10 and 11)

The Type 708-8...0 Manual/Auto Selector Switch is used for attachment to supply pressure regulators combined with positioners.

The selector switch has two switching positions. Standard position - piston (2) retracted and locking cap (3) screwed on - means automatic operation. The selector switch passes the signal pressure from the positioner on to the actuator of the control valve.

When the locking cap (3) is removed, the piston (2) can be pulled out until it stops. As a result, the signal pressure line between positioner and pneumatic actuator is interrupted and the output of the supply pressure regulator is directly connected to the actuator. Thus, the control valve can be manually adjusted on site via the adjuster (screw or rotary knob) of the supply pressure regulator.

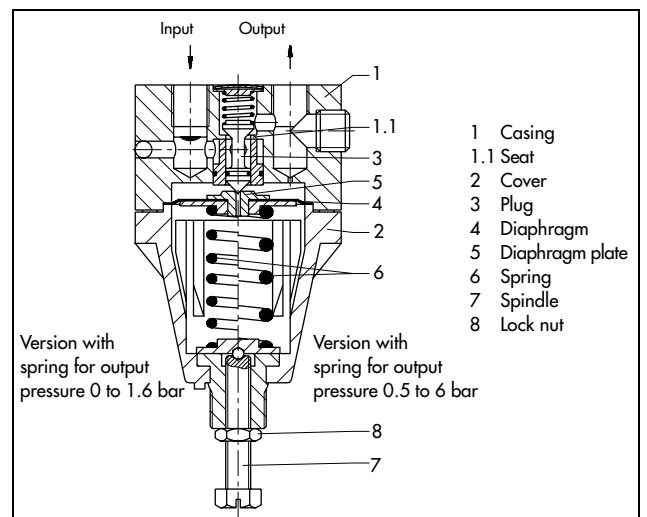

Fig. 7 · Supply pressure regulator

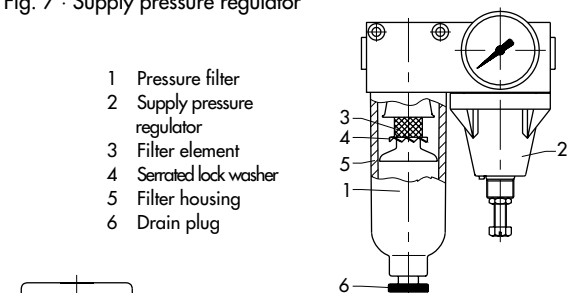

Fig. 8 · Air pressure reducing station

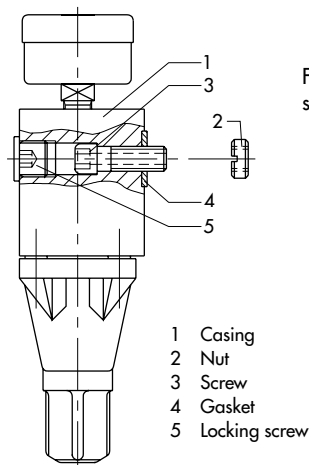

Fig. 9 · Supply pressure regulator with mounting block

- 1 Casing
- 2 Nut
- 3 Screw
- 4 Gasket
- 5 Locking screw

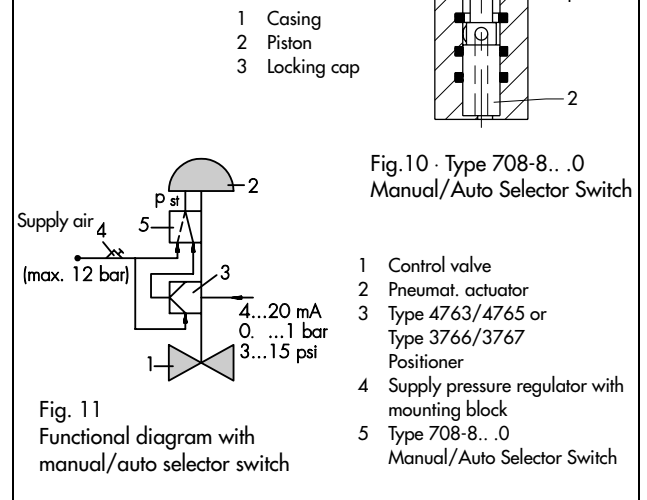

Fig. 10 · Type 708-8...0 Manual/Auto Selector Switch

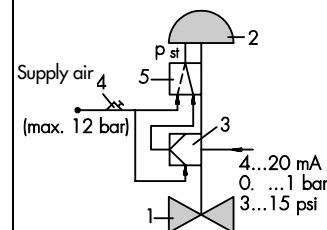

Fig. 11  
Functional diagram with  
manual/auto selector switch

- 1 Control valve
- 2 Pneumat. actuator
- 3 Type 4763/4765 or Type 3766/3767 Positioner
- 4 Supply pressure regulator with mounting block
- 5 Type 708-8...0 Manual/Auto Selector Switch

**Table 1 · Technical data** · All pressures in bar (gauge)

Input pressure	min.	1 bar (15 psi) above the adjusted set point, but at least 1.6 bar (24 psi)
	max.	12 bar (180 psi)
Output pressure	Continuously adjustable from 0 to 1.6 bar (0 to 24 psi), or from 0.5 to 6 bar (7 to 90 psi)	
Air consumption	0.1 m <sup>3</sup> /h (for supply air 7 bar)	
Air output capacity	See Fig. 12	
Perm. ambient temperature range	-25 °C to +70 °C (larger temperature range on request)	
Influence	Input pressure 0.14 %/0.1 bar	
<b>Pressure gauge</b> ∅ 40		
Scale range	0 to 1.6 bar (0 to 24 psi), or 0 to 6 bar (0 to 90 psi)	
Connection	G 1/8	
Weight, approx. kg	Type 708-0/1: 0.25	Type 708-11/12: 0.65

**Table 2 · Materials** (WN = Material No. acc. to DIN)

<b>Type 708-0/1 Supply Pressure Regulator</b>		
Casing	Die-cast aluminum, plastic-coated	
Cover	Polyamide	
Plug	Polyoxymethylene	
Measuring diaphragm	CR (chloroprene with fabric)	
Diaphragm plate	Aluminum	
<b>Type 708-11/12 Air Pressure Reducing Station, Type 708-83/84 Filter, and mounting blocks</b>		
Filter housing	Polycarbonate or aluminum	
Filter element 20 µm	Polypropylene	
<b>Pressure gauge</b>		
Casing	Stainless steel WN 1.4571	
Connection G 1/8	Copper-free stainless steel	Nickel-plated brass

### Mounting

The supply pressure regulators can be mounted in any position. Optionally, tube mounting or mounting with mounting brackets to panels, walls or valves.

When installing the air pressure reducing station, the filter must be suspended vertically in downward direction. Choice of either tube mounting or wall mounting.

### Ordering text

Type 708-...Supply Pressure Regulator

Type 708-...Air Pressure Reducing Station

Filter housing: Plastic/Aluminum

Mounting block with Type 708-...Supply Pressure Regulator

Type 708-81.2 Adapter Block

Type 708-82.0 Manual/Auto Selector Switch

without/with pressure gauge

Pressure gauge: Stainless steel casing, nickel-plated air connection / copper-free version, compl. stainless steel, without / with mounting brackets for panel mounting / wall mounting /valve attachment.

Specifications subject to change without notice.

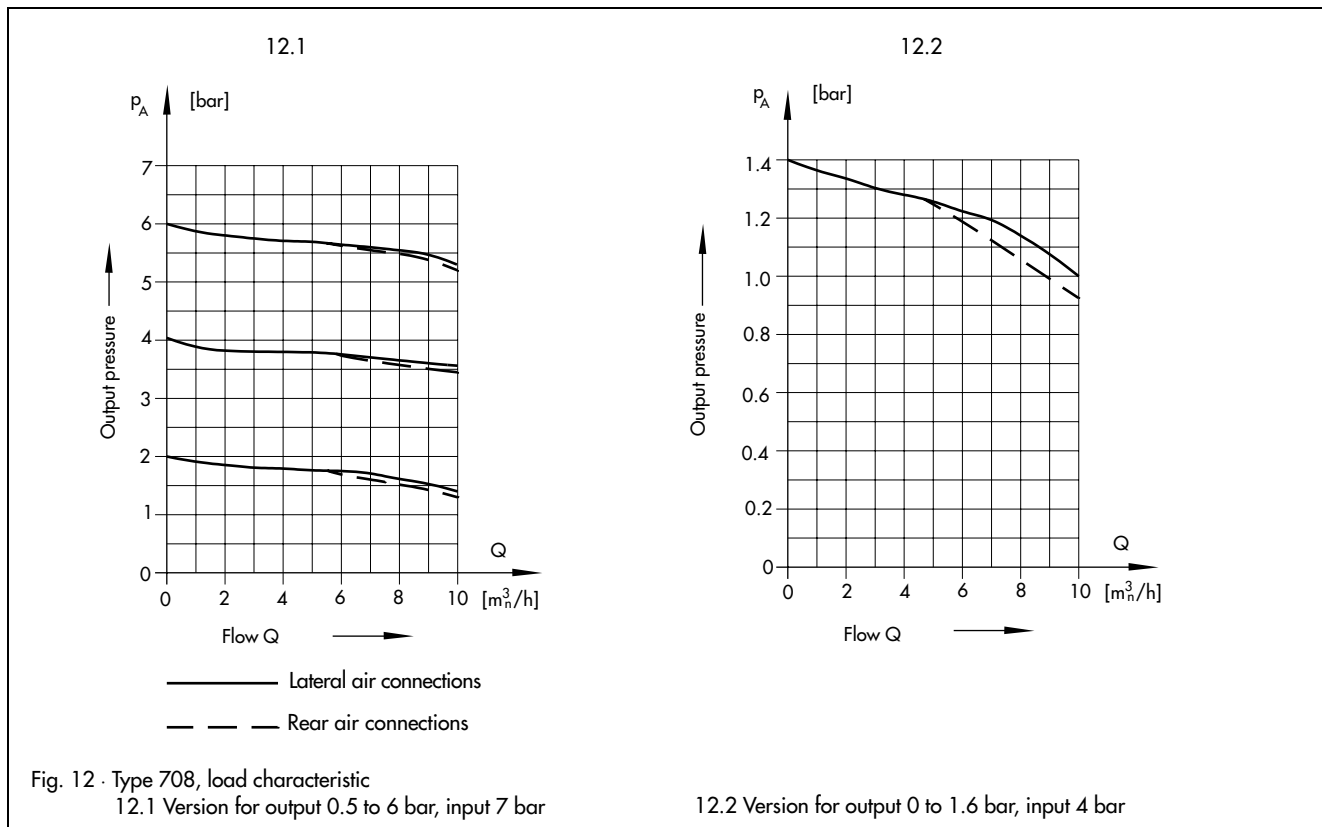

Dimensions in mm

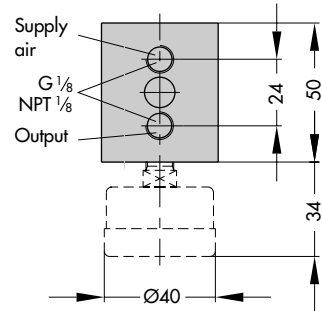
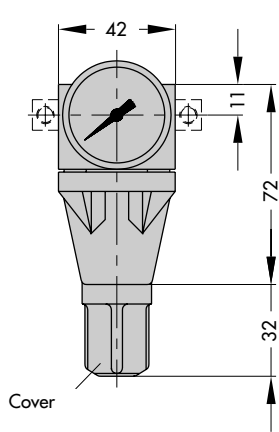

Type 708-00.. Supply Pressure Regulator for tube mounting and Type 708-5003 with Type 3430 Air Pressure Reducing Station

Double nipple for screwing a supply pressure regulator, an air pressure reducing station, or a filter to the mounting block of Type 3766 and Type 3767 Positioners

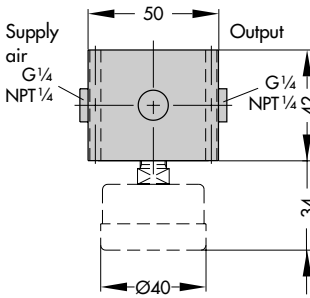
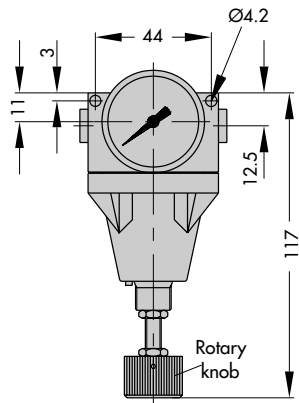
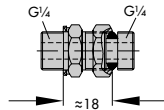

Type 708-10.. Supply Pressure Regulator for wall mounting

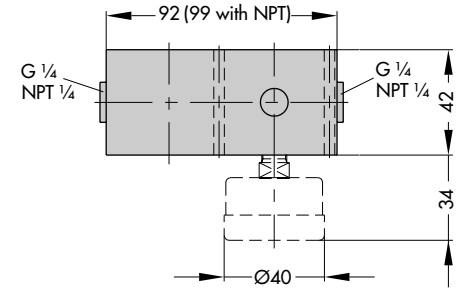
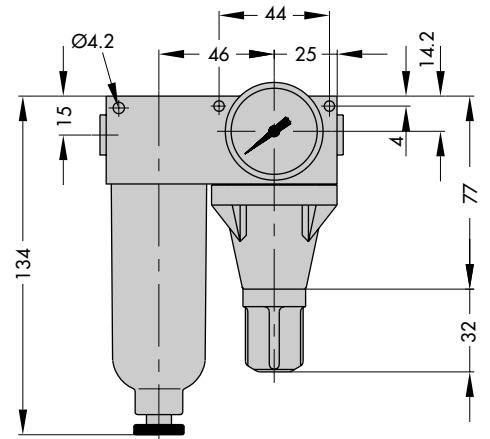

Type 708-11../12.. Air Pressure Reducing Station for tube or wall mounting

Type 708-83.. and Type 708-84.. Filters

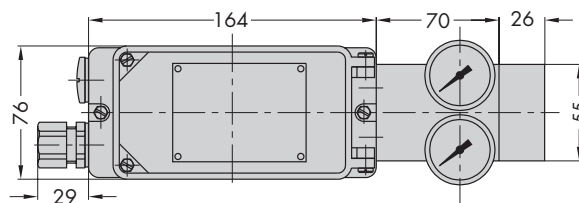
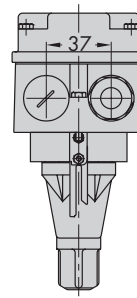
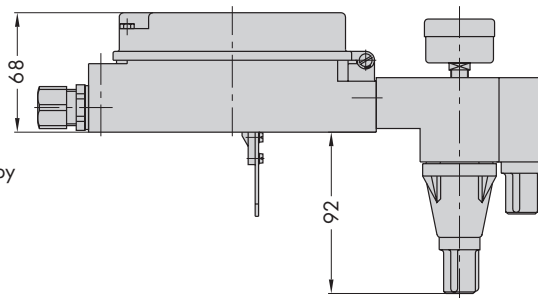
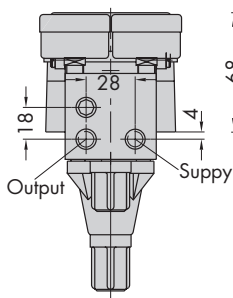
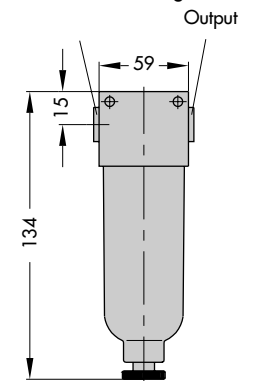

Type 3767 Electropneumatic Positioner including mounting block with Type 708-5322 Supply Pressure Regulator and Type 708-8220 Manual/Auto Selector Switch

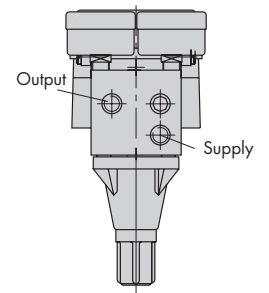

Type 708-5322 Mounting Block for Type 3766 and 3767 Positioners

Dimensions in mm

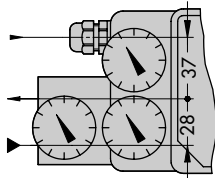

Type 708-85.0  
Manual/Auto  
Selector Switch

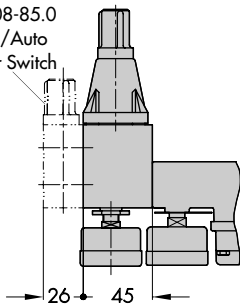

without  
Manual/auto selector switch

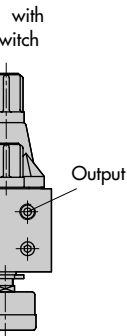
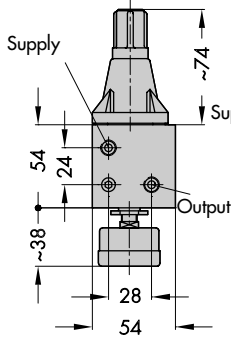

Mounting block with Type 708-55.2 Supply Pressure Regulator for Type 4765/4763 Positioner, optionally available with Type 708-85.0 Manual/Auto Selector Switch

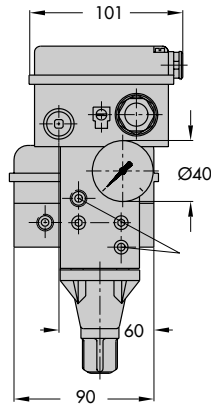
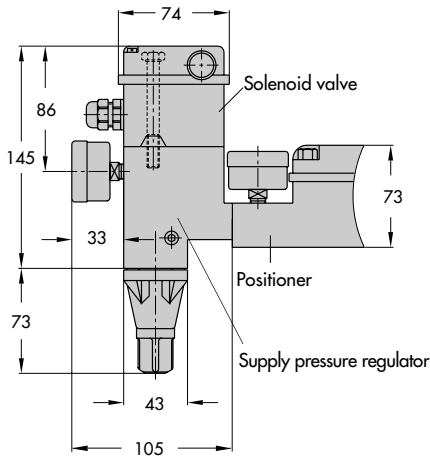

Air connections  
G 1/4 / NPT 1/4

Type 708-5422 Supply Pressure Regulator for connecting a Type 3701 Solenoid Valve to a Type 4763 or Type 4765 Positioner

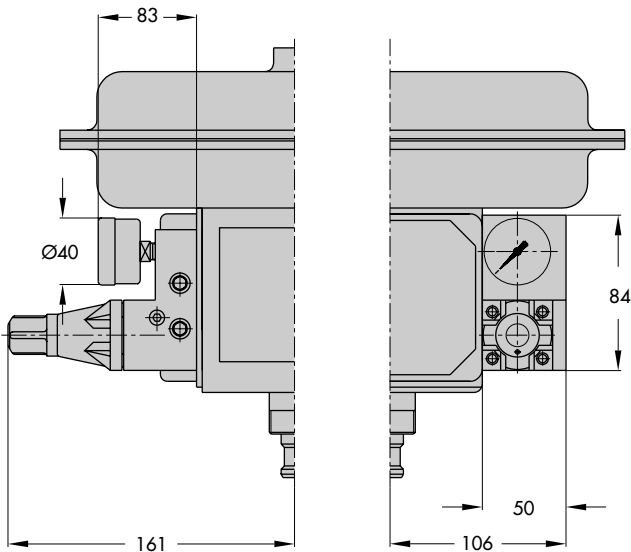

Type 708-57... Supply Pressure Regulator, attached to Type 3760 Positioner

